

Fastening Systems

C-F-2017 | (800) 999-5099 | strongtie.com

SIMPSON
Strong-Tie





Engineered to
drive easy.

Strong-Drive
STRUCTURAL FASTENERS

Deck-Drive
PREMISEH FASTENERS

Quik Drive
AUTU-TEED SCREW DRIVERS



Secure Engagement



No Predrill



Quick Starts



Fast Install

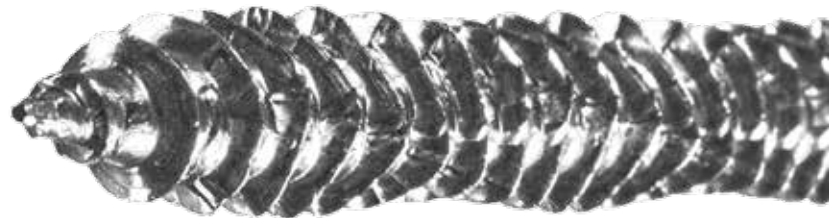

Tight Connection



Clean Finish



Table of Contents

General Information

Important Information — Warnings and Warranties	14
General Notes	15
Corrosion Information	17
Coatings and Materials	20
Fastener Overview, Nails	22
Nail Types	23
Color Guide for Composite/PVC Decking	24
Screw Features	26
How Self-Drilling Screws Work	27
Custom-Order Nails	29

Performance Products

Strong-Drive® Structural Fasteners	32
Deck-Drive™ Premium Deck Screws	34
Quik Drive® Auto-Feed Screw Driving Systems	36
Stainless-Steel Products	38

Fastener Application Guide

Decks, Docks and Boardwalks	44
Subfloor and Sheathing Applications	46
Underlayment and Backerboard Applications	47
Siding on Wood and Steel	48
Roofing	50
Wood Framing	52
Fasteners for Simpson Strong-Tie® Connectors	54
Finishing, Millwork and Trim	55
Fastening to Metal	56
Fencing	58
Cooling Towers	60
Log Homes	62
Steel Decking	62
Truss-Ply Fastening Applications	63
Drywall and Exterior Gypsum Sheathing Applications	63
Crating	64
Boat Building / Marine Trade	65

Screws

Exterior Wood Screws

Strong-Drive® SDWS FRAMING Screw	68
Strong-Drive® SDWS TIMBER Screw	69
Strong-Drive® SDWH TIMBER-HEX Screw	70
Strong-Drive® SDWH TIMBER-HEX SS Screw	71
Strong-Drive® SDWH TIMBER-HEX HDG Screw	72
Outdoor Accents® Structural Wood Screw	73
Outdoor Accents® Hex-Head Washer	73
Outdoor Accents® Connector Screw	74
Strong-Drive® SDS HEAVY-DUTY CONNECTOR Screw	75
Strong-Drive® SD CONNECTOR Screw	76
Screw Substitution Calculator	77
Deck-Drive™ DSV WOOD Screw	78
Deck-Drive™ DWP WOOD SS Screw — Flat Head	79
Deck-Drive™ DWP WOOD SS Screw — Trim Head	81
Deck-Drive™ DHPD HARDWOOD Screw	82
Bugle-Head Wood Screw — 6-Lobe Drive	83
Bugle-Head Wood Screw — Square Drive	84
Trim-Head Screw — Square Drive	86
Trim-Head Screw — 6-Lobe Drive	87

Composite Decking Screws

Deck-Drive™ DCU COMPOSITE Screw	89
Dexter™ Composite-Decking Screw	91

Interior Wood Screws

Strong-Drive® SDWC TRUSS Screw	92
Strong-Drive® SDW EWP-PLY Screw	93
Strong-Drive® SDW TRUSS-PLY Screw	94
Strong-Drive® SDWS LOG Screw	94
Strong-Drive® SDWF FLOOR-TO-FLOOR Screw	95
Strong-Drive® SDVV SOLE-TO-RIM Screw	95
Strong-Drive® WSNLT SUBFLOOR Screw	96
Wafer-Head Screw	96
MTH Underlayment Screw	96

Metal Screws

Strong-Drive® XL LARGE-HEAD METAL Screw	97
Strong-Drive® XM MEDIUM-HEAD METAL Screw	97
Strong-Drive® XE EXTERIOR STRUCTURAL METAL Screw	98
Strong-Drive® SELF-DRILLING X METAL Screw	98
Self-Drilling E Metal Screw	99
Strong-Drive® TB WOOD-TO-STEEL Screw	100
Strong-Drive® PPSD SHEATHING-TO-CFS Screw	101
Strong-Drive® FPHSD FRAMING-TO-CFS Screw	102
Steel Deck Diaphragm Calculator	103
PCSD Standing-Seam-Roofing Panel Clip Screw	104
Self-Drilling Pancake-Head Screw	104
Self-Drilling Bugle-Head Screw	105
Self-Drilling Fiber-Cement Screw	106
Self-Drilling Flat-Head Screw with Wings	107
Self-Drilling Siding Screw	108
Self-Drilling Wafer-Head Screw with Wings	109
Self-Drilling Wire-Lath Modified Truss-Head Screw	110

Parts and Accessories

Driver Bits	111
-----------------------	-----

Nails

Exterior Nails

Premium Siding Nail	114
Premium Common Nail	114
Box Nail — Annular Ring Shank	115
Box Nail — Screw-Shank Nail	115
Cedar and Redwood Decking Nail	116
Wood Siding Nail	117
Cedar Trim Nail	117
Common Nail — Annular Ring Shank	118
Common Nail — Smooth Shank	119
Fiber-Cement Siding Nail	120
Finishing Nail	121
Nail with EPDM Washer — Annular Ring Shank	122
Post and Beam Nail — Annular Ring Shank	123
Preservative-Treated Wood Decking Nail	124
Pyramid-Head Nail	125
Painted Siding Nail	126
Shake and Shingle Siding/Roofing Nail	128
Washed Roofing Nail	129
Roofing Nail — Annular Ring Shank	130
Roofing Nail — Smooth Shank	132
Tile/Slating Nail — Annular Ring Shank	133
Tile/Slating Nail — Smooth Shank	134
Custom Nail Worksheet	135

Table of Contents

Specialty Fasteners

Strong-Drive® SCNR RING-SHANK CONNECTOR Nail	138
Strong-Drive® SCN SMOOTH-SHANK CONNECTOR Nail	139
PVC Trim-Board Nail	139
Escutcheon Pins	140
Fencing Staples	141
Hog Rings — Hill Pattern	141
Marine Screw — Pan Head	142
Marine Screw — Flat Head	143
PVC Trim-Board Screw	144
Cement Board Screw	145
Fiber-Cement Screw	145
Metal-Panel Screw	146
Metal-Panel Screw with EPDM Washer	146
Self-Drilling Hex-Washer-Head Screw	147
Self-Drilling Hex-Washer-Head Screw with EPDM Sealing Washer	148
Self-Drilling Flat-Pan-Head Screw	149
Pancake-Head Screw	149
PC Standing-Seam-Roofing Panel Clip Screw	150
Trim-Head Screw with EPDM Sealing Washer	150
Wire-Lath Modified Truss-Head Screw	151
Truss-Head Screw	151
Pocket-Hole Screw	152
Storm-Panel Screw	152
Specialty Washer for Nail and Screw Assemblies	153
EB-TY® Hidden Deck Fasteners	154
Ipê Wood Plugs	155

Collated Nails and Staples

Strong-Drive® Connector Nails

Strong-Drive® 33° SCN SMOOTH-SHANK CONNECTOR Nail	158
Strong-Drive® 33° SCNR RING-SHANK CONNECTOR Nail	159

Siding/Fencing/Trim

0° Inserted Plastic Coil, Full Round Head, Ring-Shank Nail	160
15° Inserted Plastic Coil, Full Round Head, Ring-Shank Nail	161
15° Inserted Plastic Coil, White Full Round Head, Ring-Shank Nail	162
15° Wire Coil, Full Round Head, Ring-Shank Siding Nail	163
15° Wire Coil, Painted Full Round Head, Ring-Shank Nail	164

Roofing

15° Wire Coil, Full Round Head, Ring-Shank Roofing Nail	165
15° Wire Coil, Full Round Head, Smooth-Shank Roofing Nail	166

Framing

15° Wire Coil, Full Round Head, Ring-Shank Decking/Framing Nail	167
15° Wire Coil, Painted Full Round Head, Ring-Shank Decking/Framing Nail	168
20°–22° Plastic Strip, Casing Head, Ring-Shank Nail	169
20°–22° Plastic Strip, Full Round Head, Ring-Shank Nail	170
20°–22° Plastic Strip, Full Round Head, Screw-Shank Nail	171
20°–22° Plastic Strip, Full Round Head, Smooth-Shank Nail	172
31°–34° Plastic Strip, Full Round Head, Ring-Shank Nail	173
28° Wire-Weld, Clipped Head, Ring-Shank Nail	174
31°–34° Paper Tape, Clipped Head, Ring-Shank Nail	175

Trim Nails

20° Angle, Adhesive Collation, T-Style Head, 16-Gauge Finishing Nail	176
25° Angle, Adhesive Collation, FN-Style, 15-Gauge Finishing Nail	176
Straight, Adhesive Collation, T-Style Head, 16-Gauge Finishing Nail	177
Straight, Adhesive Collation, T-Style Head, 18-Gauge Brads	178
Straight, Adhesive Collation, 23-Gauge Micro Pins	179
Tape Collation, DA-Style Angle, 15-Gauge Finishing Nail	180

Specialty

L Series Flooring Cleats	181
T Series Flooring Cleats	181

Staples

½" Crown, 15½-Gauge Staples	182
1" Crown, 16-Gauge Staples	182
½" Crown, 16-Gauge Staples	183
¼" Crown, 18-Gauge Staples	184
⅞" Crown, 16-Gauge Staples	185

Quik Drive® Systems Applications

Subfloor/Sheathing	188
Decks, Docks and Boardwalks	190
Drywall	192
Fiberglass-Mat Gypsum Sheathing	194
Fiber-Cement Siding	195
Standing-Seam Metal Roofing	197
Exposed-Fastener Metal Roofing/Siding	198
Tile Roofing	200
Steel Framing/Stitching	202
Steel Decking/Stitching	204
Underlayment/Backerboard	206
Truck Beds/Trailer Flooring	208
Crating	210
Truss-Ply Fastening	212
Nailers/Ledgers-to-Steel	214

Quik Drive® Systems

Quik Drive Systems

BSD200 Structural Steel-Decking System	218
BGP300 Metal-Roofing/Siding System	219
PRO200 Drywall System	220
PRO200S Multi-Purpose System	221
PRO250 Subfloor System	222
PRO300S Decking System	223
PROHSD60 Wood-to-Steel System	224
PROHSD75 Wood-to-Steel System	225
PROHX14 Metal Roofing/Siding System	226
PROLDH Underlayment/Backerboard System	227
PRORF Roofing Tile System	228
PRO300SRF Roofing Tile System	229
PROSDX150 Steel-Decking System	230
PROPP150 Metal Roofing System	231

Quik Drive Combo Systems

PROSDD Multi-Purpose Combo System	232
PROCCS+ Multi-Purpose Combo System	233
PROCGB Underlayment/Backerboard Combo System	234

Table of Contents

Quik Drive Attachments

BSD200 Structural Steel-Decking Attachment	235
BGP300 Metal-Roofing/Siding Attachment	235
PRO200 Drywall Attachment	236
PRO200S Multi-Purpose Attachment	236
PRO250 Subfloor Attachment	237
PRO250DW Drywall Attachment	237
PRO300S Decking Attachment	238
PROHSD60 Wood-to-Steel Fastening Attachment	238
PROHSD75 Wood-to-Steel Fastening Attachment	239
PROHX14 Metal Roofing/Siding Attachment	239
PROHX516 Steel-to-Steel Fastening Attachment	240
PROLDH Underlayment/Backerboard Attachment	240
PROPH Cold-Formed Steel Framing Attachment	241
PRORF Roofing Tile Attachment	241
PRO300SRF Roofing Tile Attachment	242
PROSDX150 Steel-Decking Attachment	242
PROPP150 Metal Roofing Attachment	243

Parts and Accessories

Screwdriver Motors	244
Countersink and RPM Recommendations	246
Adapters	247
Replacement Parts	248
Accessories	249
Schematics and Troubleshooting	250
Quik Drive® — Warranty	251
Safety Warnings	251

Collated Screws for the Quik Drive® System

Application/Fastener/Tool Matrix	254
--	-----

Collated Exterior Wood Screws

Deck-Drive™ DSV WOOD Screw	256
Deck-Drive™ DWP WOOD SS Screw	257
Deck-Drive™ DHPD HARDWOOD Screw	257
Trim-Head Screw — Sharp Point	258
Trim-Head Screw — Type-17 Point	259
Bugle-Head Wood Screw	259
CB3BLG Fiber-Cement Board Screw	260
CB3BLGHL Cement Board Screw	260
HJ Metal Roofing/Siding Panel Screw	261
HG Metal Roofing/Siding Panel Screw	261
Color Guide for HJ	262
PC Standing-Seam-Roofing Panel Clip Screw	263
WSC Wood Screw	263
SSWSCB Roofing Tile Screw	264
WSCT Roofing Tile Screw	264
WSCD Roofing Tile Screw	264

Collated Composite Decking Screws

Deck-Drive™ DCU COMPOSITE Screw	265
Deck-Drive™ DCSD COMPOSITE-TO-STEEL Screw	266

Collated Interior Wood Screws

Strong-Drive® WSV SUBFLOOR Screw	267
Strong-Drive® WSNTL WOOD Screw	267
Strong-Drive® WSNTL SUBFLOOR Screw	268
WSHL Subfloor Screw	270
DWC Drywall Screw	270
DWHL Drywall Screw	271

MTH Wood Underlayment Screw	271
PC Standing-Seam-Roofing Panel Clip Screw	272
PHSS Wood Screw	273
WSC Wood Screw	273
WSCLT Wood Screw	273

Collated Metal Screws

Strong-Drive® TB WOOD-TO-STEEL Screw	274
Strong-Drive® PHSD FRAMING-TO-CFS Screw	275
Strong-Drive® FPHSD FRAMING-TO-CFS Screw	275
Strong-Drive® PPSD SHEATHING-TO-CFS Screw	276
Strong-Drive® XL LARGE-HEAD METAL Screw	277
Strong-Drive® XM MEDIUM-HEAD METAL Screw	277
Strong-Drive® SELF-DRILLING X METAL Screw	278
Steel Deck Diaphragm Calculator	279
PCSD Standing-Seam-Roofing Panel Clip Screw	280
CBSDQ Sheathing-to-CFS Screw	281
DWF Drywall-to-CFS Screw	282
DWFSD Drywall-to-CFS Screw	282
FHSD Wood-to-CFS Screw	283
WSFLRV Wood-to-CFS/Aluminum Screw	283

Technical Information

General Material Safety Data Note	286
General Load Tables	287
Strong-Drive® SDWS FRAMING Screw	288
Allowable Shear Loads	290
Allowable Withdrawal Loads	290
Screw Spacing Requirements	291
Strong-Drive® SDWS TIMBER Screw	292
Allowable Shear Loads	292
Allowable Withdrawal Loads	292
Ledger Spacing	293
Sole-to-Rim Connections	294
Ledger-to-Stud Applications	295
Connections with Gypsum Board Interlayer(s)	296
Guard Post Installations	300
Attaching Foam Insulation	304
Outdoor Accents® Structural Wood Screw	306
Outdoor Accents® Hex-Head Washer	306
Outdoor Accents® Connector Screw	307
Strong-Drive® SDWS LOG Screw	308
Allowable Shear Loads	308
Allowable Withdrawal Loads	308
Allowable Lateral Loads	310
Strong-Drive® SDWH TIMBER-HEX Screw	311
Allowable Shear Loads	311
Allowable Withdrawal Loads	311
Ledger Spacing	312
Sole-to-Rim Connections	313
Allowable Shear Loads	314
Ledger-to-Stud Applications	316
Connections with Gypsum Board Interlayer(s)	317
Strong-Drive® SDWH TIMBER-HEX HDG Screw	321
Round Pile Connection Loads	321
Shear Loads	322
Beam-to-Top-of-Post Connection	323
Strong-Drive® SDWH TIMBER-HEX SS Screw	324
Allowable Shear Loads	324
Ledger Spacing	325

Table of Contents

Fastener Types for Connectors	327	Strong-Drive® PHSD FRAMING-TO-CFS Screw	372
Strong-Drive® SDS HEAVY-DUTY CONNECTOR Screw	329	CFS Member Connection Loads	372
Allowable Shear Loads	329	Nominal Shear Strength for Wind and Seismic for Shear Walls	372
Ledger Spacing	332	Strong-Drive® FPHSD FRAMING-TO-CFS Screw	373
Sole-to-Rim Connections	333	CFS Member Connection Loads	373
Strong-Drive® SD CONNECTOR Screw	334	Nominal Shear Strength for Wind and Seismic for Shear Walls	373
Allowable Shear Loads	334	Self-Drilling E Metal Screw	374
Allowable Withdrawal Loads	334	Screw Strength	374
Approved Connectors	335	CFS Member Connection Loads	374
Strong-Drive® SCNR RING-SHANK CONNECTOR Nail	337	PC/PCSD Screws	375
Installation Information	337	CFS Member Connection Loads	375
Nail Substitution Chart	337	Wood Member Connection Withdrawal Loads	375
Over-Driven Nails in Connectors and Straps	337	PCSD Standing-Seam-Roofing Panel Clip Screw	376
Strong-Drive® SCN SMOOTH-SHANK CONNECTOR Nail	338	Nominal Shear Strength	376
Installation Information	338	DWF/DWFSD Screws	376
Characteristics Needed for Smooth-Shank Nails	338	Nominal Shear Strength for Wind	
Over-Driven Nails in Connectors and Straps	338	and Seismic Loads Shear Walls	376
Wafer-Head Screw	339	PPSD/CBSDQ/FHSD/WSFLRV Screws	377
Allowable Loads	339	Nominal Shear Strength for Wind	
Strong-Drive® SDWC TRUSS Screw	340	and Seismic Loads Shear Walls	377
Allowable Shear Loads	340	Steel-Deck Fastening	378
Allowable Withdrawal and Pull-Through Loads	340	Strong-Drive® SELF-DRILLING X METAL Screw	380
Allowable Roof-to-Wall Connection Loads	341	CFS Member Connection Loads	380
Truss/Rafter-to-Top Plate Connections	342	Strong-Drive® XL LARGE-HEAD	
Allowable Stud-to-Plate Connection Loads	344	and XM MEDIUM-HEAD METAL Screws	381
Narrow Face of Stud-to-Plate Connections	345	Screw Shear and Tension Strengths	382
Continuous Load Path Considerations	347	Structural Screw Pull-Over Strength	382
Sole-to-Rim Connections	348	Steel Deck Diaphragm Calculator	383
Top-of-Wall Assemblies	349		
Strong-Drive® SDWF FLOOR-TO-FLOOR Screw	352		
Installation Information	352		
Installation Conditions	353		
Uniform Uplift Loads	353		
Concentrated Uplift Loads	354		
Uniform Uplift Loads	355		
Strong-Drive® SDW TRUSS-PLY and EWP-PLY Screws	356		
Allowable Shear Loads	356		
Allowable Uniform Load to Either Outside Member	358		
Allowable Loads for Side-Loaded Multi-Ply Beam	359		
Built-Up Column Assemblies	361		
Allowable Compression Capacity	362		
Strong-Drive® SDWV SOLE-TO-RIM Screw	364		
Allowable Shear Values	364		
Strong-Drive® TB WOOD-TO-STEEL Screw	365		
Allowable Loads	365		
Strong-Drive® WSNTL SUBFLOOR Screw	366		
Allowable Shear	366		
Allowable Withdrawal	367		
Allowable Loads Comparison	368		
Guidelines for Fastening Diaphragms without Glue	369		
Strong-Drive® XE EXTERIOR STRUCTURAL METAL Screw	370		
CFS Member Connection Loads	370		
Screw Strength	370		
Allowable Loads for Connectors in Trex Elevations	370		
Strong-Drive® PPSD SHEATHING-TO-CFS Screw	371		
Pull-Out Loads	371		
Pull-Through Loads	371		

Index

Alphabetical Index	386
------------------------------	-----

Alphabetical Index

0° Inserted Plastic Coil, Full Round Head, Ring-Shank Nail	160
½" Crown, 15½-Gauge Staples	182
½" Crown, 16-Gauge Staples	183
½" Crown, 18-Gauge Staples	184
1" Crown, 16-Gauge Staples	182
¾" Crown, 16-Gauge Staples	185
15° Inserted Plastic Coil, Full Round Head, Ring-Shank Nail	161
15° Inserted Plastic Coil, White Full Round Head, Ring-Shank Nail	162
15° Wire Coil, Full Round Head, Ring-Shank Decking/Framing Nail	167
15° Wire Coil, Full Round Head, Ring-Shank Roofing Nail	165
15° Wire Coil, Full Round Head, Ring-Shank Siding Nail	163
15° Wire Coil, Full Round Head, Smooth-Shank Roofing Nail	166
15° Wire Coil, Painted Full Round Head, Ring-Shank Decking/Framing Nail	168
15° Wire Coil, Painted Full Round Head, Ring-Shank Nail	164
20°–22° Plastic Strip, Casing Head, Ring-Shank Nail	169
20°–22° Plastic Strip, Full Round Head, Ring-Shank Nail	170
20°–22° Plastic Strip, Full Round Head, Screw-Shank Nail	171
20°–22° Plastic Strip, Full Round Head, Smooth-Shank Nail	172
20° Angle, Adhesive Collation, T-Style Head, 16-Gauge Finishing Nail	176
25° Angle, Adhesive Collation, FN-Style, 15-Gauge Finishing Nail	176
28° Wire-Weld, Clipped Head, Ring-Shank Nail	174
31°–34° Paper Tape, Clipped Head, Ring-Shank Nail	175
31°–34° Plastic Strip, Full Round Head, Ring-Shank Nail	173

A

Accessories	249
Adapters	247
Alphabetical Index	386
Application/Fastener/Tool Matrix	254

B

BGP300 Metal-Roofing/Siding Attachment	235
BGP300 Metal-Roofing/Siding System	219
Boat Building / Marine Trade	65
Box Nail — Annular Ring Shank	115
Box Nail — Screw-Shank Nail	115
BSD200 Structural Steel-Decking Attachment	235
BSD200 Structural Steel-Decking System	218
Bugle-Head Wood Screw	259
Bugle-Head Wood Screw — 6-Lobe Drive	83
Bugle-Head Wood Screw — Square Drive	84

C

CB3BLG Fiber-Cement Board Screw	260
CB3BLGHL Cement Board Screw	260
CBSDQ Sheathing-to-CFS Screw	281
Cedar and Redwood Decking Nail	116
Cedar Trim Nail	117
Cement Board Screw	145
Coatings and Materials	20
Color Guide for Composite/PVC Decking	24
Color Guide for HJ	262
Common Nail — Annular Ring Shank	118
Common Nail — Smooth Shank	119
Cooling Towers	60
Corrosion Information	17
Countersink and RPM Recommendations	246
Crating	64, 210
Custom Nail Worksheet	135
Custom-Order Nails	29

D

Deck-Drive™	
DCSD COMPOSITE-TO-STEEL Screw	266
DCU COMPOSITE Screw	89, 265
DHPD HARDWOOD Screw	82, 257
DSV WOOD Screw	78, 256
DWP WOOD SS Screw	257
DWP WOOD SS Screw — Flat Head	79
DWP WOOD SS Screw — Trim Head	81
Premium Deck Screws	34
Decks, Docks and Boardwalks	44, 190
Dexxter™ Composite-Decking Screw	91
Driver Bits	111
Drywall	192
Drywall and Exterior Gypsum Sheathing Applications	63
DWC Drywall Screw	270
DWF Drywall-to-CFS Screw	282
DWF/DWFSD Screws	376
DWFSD Drywall-to-CFS Screw	282
DWHL Drywall Screw	271

E

EB-TY® Hidden Deck Fasteners	154
Escutcheon Pins	140
Exposed-Fastener Metal Roofing/Siding	198

F

Fastener Overview, Nails	22
Fasteners for Simpson Strong-Tie® Connectors	54
Fastener Types for Connectors	327
Fastening to Metal	56
Fencing	58
Fencing Staples	141
FHSD Wood-to-CFS Screw	283
Fiber-Cement Screw	145
Fiber-Cement Siding	195
Fiber-Cement Siding Nail	120

Fiberglass-Mat Gypsum Sheathing	194
Finishing, Millwork and Trim	55
Finishing Nail	121

G

General Load Tables	287
General Material Safety Data Note	286
General Notes	15

H

HG Metal Roofing/Siding Panel Screw	261
HJ Metal Roofing/Siding Panel Screw	261
Hog Rings — Hill Pattern	141
How Self-Drilling Screws Work	27

I

Important Information — Warnings and Warranties	14
Ipê Wood Plugs	155

L

Log Homes	62
L Series Flooring Cleats	181

M

Marine Screw — Flat Head	143
Marine Screw — Pan Head	142
Metal-Panel Screw	146
Metal-Panel Screw with EPDM Washer	146
MTH Underlayment Screw	96
MTH Wood Underlayment Screw	271

N

Nailers/Ledgers-to-Steel	214
Nail Types	23
Nail with EPDM Washer — Annular Ring Shank	122

O

Outdoor Accents® Connector Screw	74, 307
Outdoor Accents® Hex-Head Washer	73, 306
Outdoor Accents® Structural Wood Screw	73, 306

P

Painted Siding Nail	126
Pancake-Head Screw	149
PC/PCSD Screws	375
PCSD Standing-Seam-Roofing Panel Clip Screw	104, 280, 376
PC Standing-Seam-Roofing Panel Clip Screw	150, 263, 272
PHSS Wood Screw	273
Pocket-Hole Screw	152
Post and Beam Nail — Annular Ring Shank	123
PPSD/CBSDQ/FHSD/WSFLRV Screws	377
Premium Common Nail	114
Premium Siding Nail	114
Preservative-Treated Wood Decking Nail	124

Alphabetical Index

PRO200 Drywall Attachment	236	Self-Drilling Flat-Head Screw with Wings	107	Subfloor and Sheathing Applications	46
PRO200 Drywall System	220	Self-Drilling Flat-Pan-Head Screw	149	Subfloor/Sheathing	188
PRO200S Multi-Purpose Attachment	236	Self-Drilling Hex-Washer-Head Screw	147		
PRO200S Multi-Purpose System	221	Self-Drilling Hex-Washer-Head Screw with EPDM Sealing Washer	148	T	
PRO250DW Drywall Attachment	237	Self-Drilling Pancake-Head Screw	104	Tape Collation, DA-Style Angle, 15-Gauge Finishing Nail	180
PRO250 Subfloor Attachment	237	Self-Drilling Siding Screw	108	Tile Roofing	200
PRO250 Subfloor System	222	Self-Drilling Wafer-Head Screw with Wings	109	Tile/Slating Nail — Annular Ring Shank	133
PRO300S Decking Attachment	238	Self-Drilling Wire-Lath Modified Truss-Head Screw	110	Tile/Slating Nail — Smooth Shank	134
PRO300S Decking System	223	Shake and Shingle Siding/Roofing Nail	128	Trim-Head Screw — 6-Lobe Drive	87
PRO300SRF Roofing Tile Attachment	242	Siding on Wood and Steel	48	Trim-Head Screw — Sharp Point	258
PRO300SRF Roofing Tile System	229	Specialty Washer for Nail and Screw Assemblies	153	Trim-Head Screw — Square Drive	86
PROCCS+ Multi-Purpose Combo System	233	SSWSCB Roofing Tile Screw	264	Trim-Head Screw — Type-17 Point	259
PROCGB Underlayment/Backerboard Combo System	234	Stainless-Steel Products	38	Trim-Head Screw with EPDM Sealing Washer	150
PROHSD60 Wood-to-Steel Fastening Attachment	238	Standing-Seam Metal Roofing	197	Truck Beds/Trailer Flooring	208
PROHSD60 Wood-to-Steel System	224	Steel Deck Diaphragm Calculator	103, 279, 383	Truss-Head Screw	151
PROHSD75 Wood-to-Steel Fastening Attachment	239	Steel Deck Fastening	378	Truss-Ply Fastening	212
PROHSD75 Wood-to-Steel System	225	Steel Decking	62	Truss-Ply Fastening Applications	63
PROHX14 Metal Roofing/Siding Attachment	239	Steel Decking/Stitching	204	T Series Flooring Cleats	181
PROHX14 Metal Roofing/Siding System	226	Steel Framing/Stitching	202		
PROHX516 Steel-to-Steel Fastening Attachment	240	Storm-Panel Screw	152	U	
PROLDH Underlayment/Backerboard Attachment	240	Straight, Adhesive Collation, 23-Gauge Micro Pins	179	Underlayment and Backerboard Applications	47
PROLDH Underlayment/Backerboard System	227	Straight, Adhesive Collation, T-Style Head, 16-Gauge Finishing Nail	177	Underlayment/Backerboard	206
PROPH Cold-Formed Steel Framing Attachment	241	Straight, Adhesive Collation, T-Style Head, 18-Gauge Brads	178		
PROPP150 Metal Roofing Attachment	243	Strong-Drive®		W	
PROPP150 Metal Roofing System	231	33° SCNR RING-SHANK CONNECTOR Nail	159	Wafer-Head Screw	96, 339
PRORF Roofing Tile Attachment	241	33° SCN SMOOTH-SHANK CONNECTOR Nail	158	Washed Roofing Nail	129
PRORF Roofing Tile System	228	FPHSD FRAMING-TO-CFS Screw	102, 275, 373	Wire-Lath Modified Truss-Head Screw	151
PROSDD Multi-Purpose Combo System	232	PHSD FRAMING-TO-CFS Screw	275, 372	Wood Framing	52
PROSDX150 Steel-Decking Attachment	242	PPSD SHEATHING-TO-CFS Screw	101, 276, 371	Wood Siding Nail	117
PROSDX150 Steel-Decking System	230	SCNR RING-SHANK CONNECTOR Nail	138, 337	WSCD Roofing Tile Screw	264
PVC Trim-Board Nail	139	SCN SMOOTH-SHANK CONNECTOR Nail	139, 338	WSCLT Wood Screw	273
PVC Trim-Board Screw	144	SD CONNECTOR Screw	76, 334	WSCT Roofing Tile Screw	264
Pyramid-Head Nail	125	SDS HEAVY-DUTY CONNECTOR Screw	75, 329	WSC Wood Screw	263, 273
		SDWC TRUSS Screw	92, 340	WSFLRV Wood-to-CFS/Aluminum Screw	283
		SDW EWP-PLY Screw	93	WSHL Subfloor Screw	270
		SDWF FLOOR-TO-FLOOR Screw	95, 352		
		SDWH TIMBER-HEX HDG Screw	72, 321		
		SDWH TIMBER-HEX Screw	70, 311		
		SDWH TIMBER-HEX SS Screw	71, 324		
		SDWS FRAMING Screw	68, 288		
		SDWS LOG Screw	94, 308		
		SDWS TIMBER Screw	69, 292		
		SDW TRUSS-PLY and EWP-PLY Screws	356		
		SDW TRUSS-PLY Screw	94		
		SDWV SOLE-TO-RIM Screw	95, 364		
		SELF-DRILLING X METAL Screw	98, 278, 380		
		Structural Fasteners	32		
		TB WOOD-TO-STEEL Screw	100, 274, 365		
		WSNTL SUBFLOOR Screw	96, 268, 366		
		WSNTL WOOD Screw	267		
		WSV SUBFLOOR Screw	267		
		XE EXTERIOR STRUCTURAL METAL Screw	98, 370		
		XL LARGE-HEAD METAL Screw	97, 277, 381		
		XM MEDIUM-HEAD METAL Screw	97, 277, 381		
Q					
Quik Drive® Auto-Feed Screw Driving Systems	36				
Quik Drive® — Warranty	251				
R					
Replacement Parts	248				
Roofing	50				
Roofing Nail — Annular Ring Shank	130				
Roofing Nail — Smooth Shank	132				
S					
Safety Warnings	251				
Schematics and Troubleshooting	250				
Screwdriver Motors	244				
Screw Features	26				
Screw Substitution Calculator	77				
Self-Drilling Bugle-Head Screw	105				
Self-Drilling E Metal Screw	99				
Self-Drilling E Metal Screw	374				
Self-Drilling Fiber-Cement Screw	106				



Unrivaled strength.

Strong-Drive® SDWS TIMBER Screw



General Information



- Important Information — Warnings and Warranties 14
- General Notes 15
- Corrosion Information 17
- Coatings and Materials 20
- Fastener Overview, Nails 22
- Nail Types 23
- Color Guide for Composite/PVC Decking 24
- Screw Features 26
- How Self-Drilling Screws Work 27
- Custom-Order Nails 29

Company Information

For more than 50 years, Simpson Strong-Tie® has focused on creating structural products that help people build safer and stronger homes and buildings. A leader in structural systems research and technology, Simpson Strong-Tie is one of the largest suppliers of structural building products in the world. Our commitment to product development, engineering, testing and training is evident in the consistent quality and delivery of our products and services. Simpson Strong-Tie product lines include:

- Structural connectors for wood and cold-formed-steel construction
- Strong-Wall® prefabricated shearwalls
- Strong Frame® moment frames
- Strong Rod™ systems for multi-story buildings
- Fastening systems including Quik Drive® auto-feed screw driving systems
- Simpson Strong-Tie® anchors and fasteners for concrete and masonry
- Repair, Protection and Strengthening systems
- Integrated Component Solutions

For more information, visit the company's website at strongtie.com.

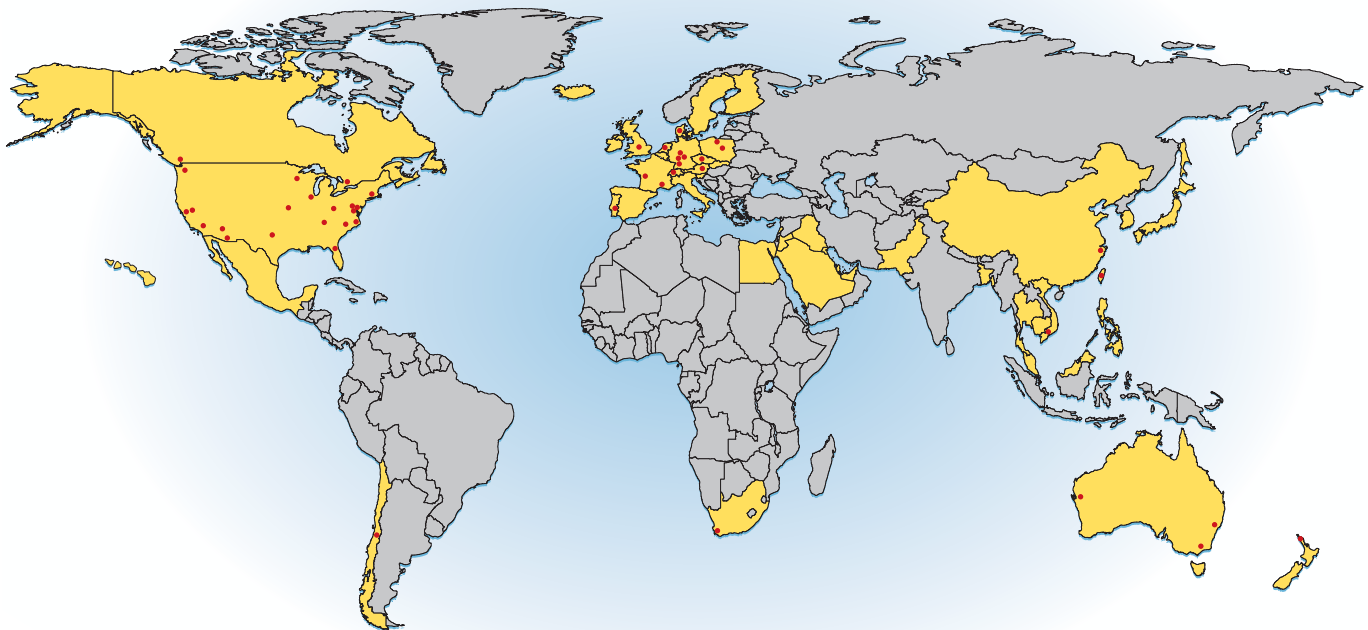

● Factories, offices, and warehouses in Australia, Austria, Canada, Chile, China, Czech Republic, Denmark, France, Germany, Netherlands, New Zealand, Poland, Portugal, South Africa, Switzerland, Taiwan, UK and USA

■ Distribution in Australia, Canada, Chile, Western Europe, part of Eastern Europe, Middle East, Japan, Korea, Egypt, Taiwan and other Asian countries, Mexico, New Zealand, South Africa, UK and USA

Company Information

The Simpson Strong-Tie Company Inc. “No Equal” Pledge Includes:

- Quality products value-engineered for the lowest installed cost at the highest-rated performance levels
- Most thoroughly tested and evaluated products in the industry
- Strategically located manufacturing and warehouse facilities
- National code agency listings
- Largest number of patented connectors in the industry
- European locations with an international sales team
- In-house R and D and tool and die professionals
- In-house product testing and quality control engineers

Member of: **AITC, ASTM, ASCE, AWPA, ACI, AISC, CSI, ICFA, NBMDA, NLBMDA, SDI, SETMA, STAFDA, SREA, NFBA, WTCA** and local engineering groups.

The Simpson Strong-Tie Quality Policy

We help people build safer structures economically. We do this by designing, engineering and manufacturing “No Equal” structural connectors and other related products that meet or exceed our customers’ needs and expectations. Everyone is responsible for product quality and is committed to ensuring the effectiveness of the Quality Management System.

Karen Colonias
President,
Chief Executive Officer

Getting Fast Technical Support

When calling for engineering technical support, having the following information at hand will help us to serve you promptly and efficiently.

- Which Simpson Strong-Tie catalog are you using? (See the front cover for the catalog number.)
- Which Simpson Strong-Tie product are you using?
- What is the type and thickness of the materials you are fastening?
- What is your load requirement?
- If using a Quik Drive attachment:
 - What attachment are you using?
 - What is the RPM range of your screwdriver motor or model number?

We Are ISO 9001-2008 Registered

Simpson Strong-Tie is an ISO 9001-2008 registered company. ISO 9001-2008 is an internationally-recognized quality assurance system which lets our domestic and international customers know that they can count on the consistent quality of Simpson Strong-Tie® products and services.



General Information	10–29	General Information
Performance Products	30–41	Performance Products
Fastener Application Guide	42–65	Fastener Applications
Screws	66–111	Screws
Nails	112–135	Nails
Specialty	136–155	Specialty
Collated Nails and Staples	156–185	Collated Nails and Staples
Quik Drive® System Application Guide	186–215	Quik Drive® Applications
Quik Drive Systems	216–251	Quik Drive® Systems
Collated Screws for the Quik Drive System	252–283	Quik Drive® Collated Screws
Technical Information	284–383	Technical Information

Important Information – Warnings and Warranties

Warning

Simpson Strong-Tie® fasteners and fastening products are designed and tested for certain applications and environments. To obtain optimal performance from Simpson Strong-Tie products, the products must be properly installed and used in accordance with the installation instructions and design limits provided by Simpson Strong-Tie Company Inc.

To ensure proper installation and use, designers and installers must carefully read the following General Notes, catalog pages for specific product installation and instructions and notes.

Proper product installation requires careful attention to all notes and instructions. Installers, designers, engineers and consumers should consult the Simpson Strong-Tie Company Inc. website at strongtie.com to obtain additional design and installation information, including:

- Information on workshops Simpson Strong-Tie conducts at various training centers throughout the country
- Code Reports
- Technical fliers and bulletins
- Corrosion information
- Answers to frequently asked questions and technical topics

Failure to follow fully all of the notes and instructions provided by Simpson Strong-Tie Company Inc. may result in improper installation of products. Improperly installed products may not perform to the specifications set forth in this catalog.

Simpson Strong-Tie Company Inc. does not guarantee the performance or safety of products that are modified, improperly installed or not used in accordance with the design and load limits set forth in this catalog.

Terms and Conditions of Sale

Product Use

Products in this catalog are designed and manufactured for the specific purposes shown, and should not be used for any other purposes unless approved by a qualified Designer. Modifications to products or changes in installation procedures should only be made by a qualified Designer. The performance of such modified products or altered installation procedures is the sole responsibility of the Designer.

Indemnity

Customer or Designers modifying products or installation procedures, or designing non-catalog products for fabrication by Simpson Strong-Tie Company Inc. shall, regardless of specific instructions to the user, indemnify, defend, and hold harmless Simpson Strong-Tie Company Inc. for any and all claimed loss or damage occasioned in whole or in part by non-catalog or modified products.

Non-Catalog and Modified Products

Consult Simpson Strong-Tie Company Inc. for applications for which there is no catalog product or for fasteners for use in applications not specifically listed for the product.

Non-catalog products must be designed by the customer and will be supplied by Simpson Strong-Tie Company Inc. in accordance with customer specifications.

Simpson Strong-Tie Company Inc. cannot and does not make any representations regarding the suitability of use or load-carrying capacities of non-catalog products. Simpson Strong-Tie Company Inc. provides no warranty, express or implied, on non-catalog products. F.O.B. shipping point unless otherwise specified.

Limited Warranty

This Limited Warranty must be read in conjunction with the General Notes, Corrosion Information, and Terms and Conditions of Sale.

Simpson Strong-Tie Company, Inc. ("Simpson") warrants catalog products to be free from defects in material or manufacturing. Simpson products are further warranted for adequacy of design when used in accordance with design limits in this catalog, and properly specified and installed. This warranty does not apply to products used not in compliance with specific applications and installation procedures set

forth in this catalog, or to non-catalog or modified products, or to deterioration due to environmental conditions.

Simpson products are designed to the load capacities and uses listed in this catalog. Properly installed Simpson products will perform in accordance with the specifications set forth in the applicable Simpson Strong-Tie® catalog. Additional performance limitations for specific products may be listed on the applicable catalog pages.
(continued on next page)

Warranties and General Notes

Limited Warranty (cont.)

Due to the particular characteristics of potential impact events, the specific design and location of the structure, the building materials used, the quality of construction, and the condition of the soils involved, damage may nonetheless result to a structure and its contents even if the loads resulting from the impact event do not exceed Simpson Strong-Tie catalog specifications and Simpson Strong-Tie® products are properly installed in accordance with applicable building codes. All warranty obligations of Simpson shall be limited, at the discretion of Simpson to repair or replacement of the defective part(s). These remedies shall constitute Simpson's sole obligation and sole remedy of purchaser under this warranty. This warranty may change periodically — consult this website for current information.

SIMPSON DISCLAIMS ALL OTHER WARRANTIES, EXPRESS OR IMPLIED, INCLUDING BUT NOT LIMITED TO IMPLIED WARRANTIES OF MERCHANTABILITY AND FITNESS FOR A PARTICULAR PURPOSE. IN NO EVENT WILL SIMPSON BE LIABLE FOR INCIDENTAL, CONSEQUENTIAL, PUNITIVE OR SPECIAL DAMAGES OR DIRECT OR INDIRECT LOSS OF ANY KIND, INCLUDING BUT NOT LIMITED TO PROPERTY DAMAGE AND PERSONAL INJURY. SIMPSON'S ENTIRE LIABILITY IS LIMITED TO THE PURCHASE PRICE OF THE PRODUCT. SOME STATES DO NOT ALLOW LIMITATIONS ON IMPLIED WARRANTIES, OR THE EXCLUSION OR LIMITATION OF INCIDENTAL OR CONSEQUENTIAL DAMAGES, SO THE ABOVE LIMITATIONS AND EXCLUSIONS MAY NOT APPLY TO YOU. THIS LIMITED WARRANTY GIVES YOU SPECIFIC LEGAL RIGHTS, AND YOU MAY ALSO HAVE OTHER RIGHTS THAT VARY FROM STATE TO STATE.

General Notes

These notes are provided to ensure proper selection and installation of Simpson Strong-Tie Company Inc. products and must be followed carefully.

- a. Simpson Strong-Tie Company Inc. reserves the right to change specifications, designs and models without notice or liability for such changes.
- b. Do not exceed published loads, doing so could jeopardize the connection.
- c. A fastener that splits the wood will not take the design load. Evaluate splits to determine if the connection will perform as required. Dry wood may split easily and should be evaluated as required. If wood tends to split consider pre-boring holes with diameters specified in the 2015 Edition National Design Specification (NDS) sections 12.1.5 for screws and 12.1.6 for nails.
- d. Fasteners may break if driven into hard materials or if countersunk below the surface of the substrate fastened.
- e. Do not overdrive fasteners. Overdriven fasteners may have a reduction in shear and pull-through capacity.
- f. Use products only in accordance with all instructions.
- g. All specified fasteners must be installed according to the instructions in this catalog.
- h. There are many choices of fasteners, tools and other products. It is often difficult to determine which type of product is best suited for your application. In some cases, there may be more than one type of product that will work well. The information in this catalog is intended to guide the Designer toward the product best suited for the specific application, use and environment. The choice of which product to use should be made by a qualified Designer.
- i. All connected members and related elements shall be designed by the Designer.
- j. Select fasteners of a type, size, length, thread, head, coating, material, point and other characteristics suitable for your application, use and environment. Incorrect fastener selection may cause the connection to fail.
- k. If using a fastener from this catalog with any other Simpson Strong-Tie product, consult the appropriate Simpson Strong-Tie catalog or strongtie.com for detailed information concerning the other product.
- l. Only use fasteners for their intended purpose as described in this publication. Connection failures can result from inappropriate substitution.
- m. Test drive fasteners to assure fasteners install correctly.
- n. The term "Designer" used throughout this catalog is intended to mean a licensed/certified building design professional, a licensed professional engineer or licensed architect.
- o. Follow material manufacturer's installation instructions and fastener recommendations.
- p. Unless otherwise noted, dimensions are in inches, loads are in pounds and shear loads are applied perpendicular to edge.
- q. Unless otherwise noted, nail "penny size" does not imply specific diameters or load capacities. Design standards must be used in conjunction with fastener material, diameter and length to determine acceptable uses.
- r. Use Quik Drive® tools only with authentic Quik Drive fasteners. Other fasteners will void the warranty and may cause the tool to malfunction and become damaged.
- s. If a Quik Drive product is compatible with a specified tool, do not use the product with any other tool.
- t. Power-driven fasteners may deflect and injure the operator or others. Follow the tool manufacturer's operating instructions and use appropriate safety equipment.
- u. Choose the proper tool to suit the fastener and applications.
- v. Use proper safety equipment and follow all safety instructions.

Important Information and General Notes

- w. Always wear protective eyewear.
- x. With the use of any power or pneumatic tools, follow manufacturer's safety instructions.
- y. Dissimilar metal combinations should be carefully assessed and avoided if possible.
- z. All carbon steel based fasteners have the potential to corrode and rust.
- aa. Some hardened fasteners may have premature failure if exposed to moisture. These fasteners are recommended to be used in interior dry conditions.
- ab. Select a fastener only after reading the corrosion information on pp. 17–21 of this catalog.
- ac. Be aware of special conditions that may increase corrosion risk and select product accordingly.
- ad. Screws made from austenitic stainless steel are generally softer and have less torsional strength than screws made from carbon steel. Simpson Strong-Tie does not assume liability for breakage or damage due to screw breakage during or after installation. Pre-drilling may be necessary in some case. For best results, drive at 2,500 RPM or less.
- ae. This catalog includes all information available as of the effective date of publication. Please consult strongtie.com for current information.

Deck Construction and Fastening Tips

- Before beginning construction, allow your decking materials to acclimate to the jobsite conditions. A freshly pressure treated deck board can contain over a gallon of liquid.
- Select the proper fastener based on the importance of the connection, exposure, and the materials that are being fastened. Consult pp. 17–21 of this catalog or strongtie.com for guidelines on choosing the correct fastener.
- Consider using 300 series stainless-steel fasteners when elevated exposure conditions may exist, such as presence of de-icing salts or close proximity to swimming pools, hot tubs, sprinklers, ponds, foliage and other resident moisture sources.
- Inadequate gap spacing between boards can put additional load on the fasteners and lead to broken screws or nail pops.
- Orienting the crown of the deck board “bark side up” will help to shed water and reduce cupping and other weathering-related defects
- Use caution to avoid overdriving fasteners during installation, which can cause breakage.
- Allow for proper water drainage. A deck should angle away from the structure a minimum of 1/8" for every 8' to reduce the possibility of standing water.
- If 3/4" decking is to be installed diagonally, reduce the on-center joist spacing to 12" versus standard 16".
- Adequate ventilation is necessary to minimize cupping, warping and other weathering related defects. Construct the deck a minimum of 18 inches off the ground to allow proper airflow. If this is not possible, reduce on-center joist spacing to 12" versus standard 16". A moisture barrier (landscape fabric) under the deck, covered with gravel is also a good practice.
- Proper maintenance is essential. Staining and sealing, along with periodic inspection of fasteners and hardware, will potentially add years to the life of the deck.

For more information on deck construction and products from Simpson Strong-Tie, please see our Deck Connection and Fastening Guide (F-DECKCODE) and the technical bulletin, Guardrail Post Installations Using Strong-Drive® SDWS Timber Screws (T-F-SDWSGRD).

Please refer to the American Wood Council's Prescriptive Residential Wood Deck Construction Guide (DCA 6) for important information on best practices and code compliant design.

Trademark Attribution

4-Cut®, Accents®, Accuset®, AEG®, Aircor®, Airy®, Akuzuki®, Apach®, Arbor®, Archer®, Arrow®, Atro®, Atlas Copco®, AZEK®, BeA®, Besco®, Black & Decker®, Bosch®, Bostitch®, Cadex®, Campbell Hausfeld®, Central Pneumatic®, Chicago Pneumatic®, Craftsman®, Craftex®, DeWalt®, Docksider®, Duo-Fast®, DuraLife™, Eagle®, Earthwood Evolutions®, E-Coat®, Enhance®, Envision®, Escapes®, Essential Collection®, Evergrain®, E-Z Fasten®, Fasco®, Fein®, Fiberon®, Floorizon®, Freeman®, Good Life®, Grex®, Grip-Rite®, Grizzly®, Harvest®, Haubold®, HighPro®, Hilti®, Hitachi®, Horizon®, ISM®, Jamerco®, Makita®, Max®, Maxus®, Leland Master Gripper™, Metabo®, Milwaukee®,

MoistureShield®, Mylar®, N2000®, Northern Tool®, Numax®, Palmgren®, Paslode®, Phillips®, Pneutools®, Porta-Nails®, Porter Cable®, Pownail®, Prebena®, Primeair®, Primatex®, Protect Advantage®, Porter Cable®, Ramsond®, Reliaboard®, Rigid®, Sanctuary®, Select®, Senco®, Siesta®, Sioux®, Snap-On®, Spotnails®, Stanley®, Stan-Tech®, Supco®, Superior®, Surebonder®, TimberTech®, Transcend®, Trex®, Trex Elevations and Trex Transcend®, Twinfinish®, Vantage Collection®, Vintage Collection®, Wen®, Westward® and XLM® are registered trademarks of their respective companies.

Corrosion Information

Understanding the Corrosion Issue

Many environments and materials can cause corrosion including ocean salt air, fire-retardants, fumes, fertilizers, preservative-treated wood, de-icing salts, dissimilar metals and more. Metal fasteners could corrode and lose load-carrying capacity when installed in corrosive environments or when installed in contact with corrosive materials.

The many variables present in a building environment make it impossible to accurately predict if, or when, corrosion will begin or reach a critical level. This relative uncertainty makes it crucial that specifiers and users are knowledgeable of the potential risks and select a product suitable for the intended use. It is also prudent that regular maintenance and periodic inspections are performed especially for outdoor applications.

It is common to see some corrosion in outdoor applications. Even stainless steel can corrode. The presence of some corrosion does not mean that load capacity has been affected or that failure is imminent. If significant corrosion is apparent or suspected, then the wood, fasteners and connectors should be inspected by a qualified engineer or qualified inspector. Replacement of affected components may be appropriate.

Some wood-preservative chemicals and fire retardant chemicals and retentions pose increased corrosion potential and are more corrosive to steel connectors and fasteners than others. Testing by Simpson Strong-Tie has shown that Alkaline Copper Quaternary-Type D (ACQ-Type D) is more corrosive than Copper Azole Type C, Micronized Copper Azole, and Chromated Copper Arsenate-Type C (CCA-C). At the same time, others have shown that the inorganic boron treatment chemicals, specifically SBX-DOT, is less corrosive than CCA-C.

Due to the many different chemical treatment formulations, chemical retention levels, moisture conditions and regional formulation variants, selection of fasteners has become a complex task. We have attempted to provide basic knowledge on the subject here, but it is important to fully educate yourself by reviewing our technical bulletins on the topic (strongtie.com/info) and also by reviewing information, literature and evaluation reports published by others.

Galvanic Corrosion - Galvanic corrosion occurs when two electrochemically dissimilar metals contact each other in the presence of an electrolyte (such as water) that acts as a conductive path for metal ions to move from the more anodic to the more cathodic metal. In the galvanic couple, the more anodic metal will corrode preferentially. The Galvanic Series of Metals table provides a qualitative guide to

the potential for two metals to interact galvanically. Metals in the same group (see table) have similar electrochemical potentials. The farther the metals are apart on the table, the greater the difference in electrochemical potential, and the more rapidly galvanic corrosion will occur. Corrosion also increases with increasing conductivity of the electrolyte.

Good detailing practice, including the following, can help reduce the possibility of galvanic corrosion of fasteners:

- Use fasteners and metals with similar electrochemical properties
- Separate dissimilar metals with insulating materials
- Ensure that the fastener is the cathode when dissimilar metals are present
- Prevent exposure to and pooling of electrolytes

Galvanic Series of Metals

Corroded End (Anode)
Magnesium Magnesium alloys Zinc
Aluminum 1100 Cadmium Aluminum 2024-T4 Iron and Steel
Lead Tin Nickel (active) Inconel Ni-Cr alloy (active) Hastelloy alloy C (active)
Brasses Copper Cu-Ni alloys Monel
Nickel (passive)
304 stainless steel (passive) 316 stainless steel (passive) Hastelloy alloy C (passive)
Silver Titanium Graphite Gold Platinum
Protected End (Cathode)

Hydrogen-Assisted Stress-Corrosion Cracking

Some hardened fasteners may experience premature failure if exposed to moisture as a result of hydrogen-assisted stress-corrosion cracking. These fasteners are recommended specifically for use in dry service locations.

Corrosion Information

Treatment Use Categories and Exposure Conditions

The American Wood Protection Association (AWPA) identifies 12 Use Category designations (UC) for wood treatment chemicals that are based on protection of the wood material; the Use Categories are based on service conditions and environments and agents of deterioration. At the same time, the building codes require specific corrosion resistance for fasteners that are in contact with chemically treated wood. From the building code perspective, fastener corrosion resistance is provided by hot-dip galvanization applied following ASTM A153, Class D or a corrosion resistant base metal, such as stainless steel, silicon bronze or copper regardless of exposure.

Some exceptions are provided in the International Code Council's (ICC) International Residential Code (IRC) for mechanical galvanization applied to screws.

The International Code Council — Evaluation Service (ICC-ES) implemented AC257 as a method to evaluate alternate corrosion resistance mechanisms for fasteners used in wood construction where hot-dip galvanization (ASTM A153, Class D) is used as the benchmark performance. Under ICC-ES AC257, fastener corrosion resistance is qualified for one or more of four exposure conditions: (1) treated wood in dry-service with no air-borne salt; (2) clean wood in a salt air, dry-service environment; (3) treated wood in a wet-service condition with no salt exposure; and (4) general use with no limitations.

Simpson Strong-Tie General Recommendations

Simpson Strong-Tie has evaluated the AWPA Use Categories (AWPA U1-16) and the ICC-ES AC257 Exposure Conditions and developed from that evaluation a set of Corrosion Resistance Recommendations. These recommendations address the coating systems and materials used by Simpson Strong-Tie for fastener products.

Dry-service (or damp-service) environments lead to wood moisture contents less than or equal to 19%. The corrosion potential, even in chemically treated wood, is reduced in these conditions. These conditions are typical of AWPA UC1 and UC2 for wood treatment and AC257 Exposure Condition 1. See the Corrosion Resistance Classification Table for the Simpson Strong-Tie assessment of corrosion needs in these conditions. The AC257 Exposure Condition 2 reflects the presence of air-borne salt in a dry-service environment and corrosion hazard to exposed metal surfaces; it does not include effects of treatment chemicals.

Outdoor environments are generally more corrosive to steel either because the moisture exposure is elevated (greater than 19%) and/or the treatment chemical retention level is higher than for interior service. The AWPA classifies exterior above ground treatments as Use Categories UC3 (A and B) depending on moisture run-off; and for ground-contact levels of protection, it has Use Categories UC4 (A-C). ICC-ES considers the exterior exposure to be limited by the type of chemicals and retention level of the chemicals in the qualification testing and whether the exposure includes salt exposure. In general, The AC257 Exposure Condition 3 includes AWPA Use Categories UC1 (interior dry) to UC4A (exterior ground contact, general use).

Types 316/305/304 stainless steel, copper, silicon bronze and hot-dip galvanized (Class-C) are the most effective protection against corrosion risk, where Type 316 is the best choice for salt marine and chloride containing environments regardless of

treatment chemicals or wood species. If you choose to use hot-dip galvanized (Class-D), mechanically galvanized (C3, N2000, or Class 55), double-barrier or Quik Guard coated fasteners on outdoor projects (e.g., a deck), you should periodically inspect the fasteners or have a professional inspection performed, and regular maintenance is a good practice. See the Corrosion Resistance Classifications Table for the Simpson Strong-Tie assessment of the corrosion resistance associated with materials and coatings and an appropriate level of corrosion resistance for various environments.

Due to the many variables involved, Simpson Strong-Tie cannot provide estimates of service life of connectors and fasteners. We suggest that all users and specifiers obtain recommendations on corrosion from the treated wood supplier or for the type of wood used. As long as Simpson Strong-Tie recommendations are followed, Simpson Strong-Tie stands behind its product performance and our standard warranty applies (pp. 14–15).

Simpson Strong-Tie does not recommend painting stainless steel fasteners or hardware. The reason behind this recommendation is that sometimes painting can facilitate corrosion. Stainless steel is “stainless” because it forms a protective chromium oxide film on the surface by passive oxidation with air. The paint film on the stainless steel surface may be imperfect or it can be injured during service, and in either case the metal may be exposed. Microscopic-sized film imperfections and scratches facilitate collection of dirt and water that can be stagnant and degrade or block the passive formation of the protective chromium oxide film. When this happens, crevice corrosion can initiate. Crevice corrosion eventually becomes visible as a brown stain or as red rust. This is the reason that painting usually does not improve corrosion resistance of stainless steel.

Corrosion Information

Guidelines for Selecting Corrosion-Resistant Fasteners

Evaluate the Application

Consider the importance of the connection.

Evaluate the Exposure

Consider these moisture and treatment chemical exposure conditions:

- **Dry service:** Generally interior applications and includes wall and ceiling cavities, raised floor applications in enclosed buildings that have been designed to prevent condensation and exposure to other sources of moisture. AWPA UC1 and UC2 are typical.
- **Wet Service:** Generally exterior construction in conditions other than Elevated Service. These include Exterior Protected and Exposed typical of AWPA UC3A and UC3B and General Use Ground Contact as described by the AWPA UC4A.
- **Elevated Service:** Includes fumes, fertilizers, soil, some preservative-treated wood (AWPA UC4B and UC4C), industrial zones, acid rain and other corrosive elements.
- **Uncertain:** Unknown exposure, materials, or treatment chemicals.
- **Ocean/Water Front:** Marine environments that include airborne chlorides and salt splash. Environments with de-icing salts are included.
- **Treatment Chemicals:** See AWPA Use Category Designations. The preservative-treated wood supplier should provide all of the pertinent information about the wood being used. The information should include Use Category Designation, wood species group, wood treatment chemical and chemical retention. See appropriate evaluation reports for corrosion effects of treatment chemicals and fastener corrosion resistance recommendations.
- **Fire-Retardant-Treated (FRT) Wood:** In the absence of FRT manufacturer recommendations with respect to corrosion resistance, the 2015 IBC Section 23.10.5.4 and IRC R317.3.4 require fasteners to be hot-dip galvanized, stainless steel, silicon bronze or copper. Some FRT manufacturers permit low-resistance coatings for dry service conditions. Fastener shear and withdrawal capacities may be reduced in FRT lumber. Refer to the FRT manufacturer's evaluation report for corrosion information and strength reduction factors.

Use the Simpson Strong-Tie® Corrosion Classification Table

If the treatment chemical information is incomplete, Simpson Strong-Tie recommends the use of a 300 series stainless-steel product. Also if the treatment chemical is not shown in the Corrosion Classification Table, then Simpson Strong-Tie has not evaluated it and cannot make any recommendations other than the use of coatings and materials in the Severe category. Manufacturers may independently provide test results of other product information; Simpson Strong-Tie expresses no opinion regarding such information.

Corrosion Resistance Recommendations			
Low	Medium	High	Severe
Phosphate (gray, black), Clear (bright) zinc (ASTM F1941), Heavy electro-galvanized (ASTM A641-Class 1), Yellow zinc (ASTM F1941), Electrocoat (E-coat), Type 410 stainless steel	Mechanically galvanized (AS 3566.2-C3, N2000, ASTM B695-Class 55), Quik Guard® coating, Hot-dip galvanized (ASTM A153-Class D), Double-barrier coating	Type 304 stainless steel, Type 305 stainless steel	Type 316 stainless steel, Hot-dip galvanized (ASTM A153-Class C), Silicon bronze, Copper

Corrosion Resistance Classifications							
Environment	Material to be Fastened						
	Untreated Wood or Other Material	Preservative-treated Wood					FRT Wood
		SBX-DOT Zinc Borate	Chemical Retention ≤ AWPA, UC4A	Chemical Retention > AWPA, UC4A	ACZA	Other or Uncertain	
Dry service	Low	Low	Low	High	Med	High	Med
Wet service	Med	N/A	Med	High	High	High	High
Elevated service	High	N/A	Severe	Severe	High	Severe	N/A
Uncertain	High	High	High	Severe	High	Severe	High
Ocean/Water front	Severe	N/A	Severe	Severe	Severe	Severe	N/A

1. These are general guidelines that may not consider all application criteria. Refer to product specific information for additional guidance.
2. Type 316/305/304 stainless-steel products are recommended where preservative-treated wood used in ground contact has chemical retention level greater than those for AWPA UC4A; CA-C, 0.15 pcf; CA-B, 0.21 pcf; micronized CA-C, 0.14 pcf; micronized CA-B, 0.15 pcf; ACQ-Type D (or C), 0.40 pcf.
3. Testing by Simpson Strong-Tie following ICC-ES AC257 showed that mechanical galvanization (ASTM B695, Class 55), Quik Guard coating, and Double Barrier coating will provide corrosion resistance equivalent to hot-dip galvanization (ASTM A153, Class D) in contact with chemically treated wood in dry service and wet service exposures (AWPA UC1-UC4A, ICC-ES AC257 Exposure Conditions 1 and 3) and will perform adequately subject to regular maintenance and periodic inspection.
4. Mechanical galvanizations C3 and N2000 should not be used in conditions that would be more corrosive than AWPA UC3A (exterior, above ground, rapid water run off).
5. If uncertain about Use Category, treatment chemical, or environment, use Types 316/305/304 stainless steel, silicon bronze or copper.
6. Some treated wood may have excess surface chemicals making it potentially more corrosive than lower retentions. If this condition is suspected, use Type 316/305/304 stainless steel, silicon bronze, or copper fasteners.
7. Type 316 stainless steel, silicon bronze, and copper fasteners are the best recommendation for ocean salt-air and other chloride-containing environments. Hot-dip galvanized fasteners with at least ASTM A153, Class C protection can also be an alternate for some applications in environments with ocean air and/or elevated wood moisture content.
8. Some woods, such as cedars, redwood and oak, are naturally corrosive and will interact with carbon steel resulting in chemical stain and/or metal corrosion; use stainless steel.

Interior Dry



Wet Service

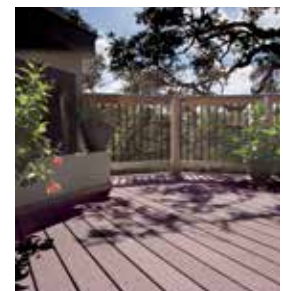

Ocean/Water Front

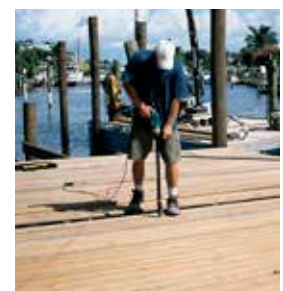

Coatings and Materials

Simpson Strong-Tie® fasteners feature a wide range of materials and coatings designed to meet specific performance criteria. It is important to select a material and/or coating that is suitable for the intended application and environment based upon factors such as corrosion resistance and mechanical properties of the material. See p. 19 for more information on selecting fasteners based upon corrosion resistance.

Simpson Strong-Tie Company Inc. welcomes the opportunity to provide assistance in fastener selection. Please call (800) 999-5099 in the event that technical support is needed.

Low Level of Corrosion Resistance



Clear Zinc

Electroplated clear zinc is applied in accordance with ASTM F1941. In the ASTM B117 salt spray test, clear zinc provides 12 to 24 hours of corrosion protection before the first appearance of red rust depending on coating thickness.

Electrocoating (E-Coat™)

Electrocoat utilizes electrical current to deposit the coating material onto the fastener. After application, the coating is oven cured. Electrocoat is intended for dry, low corrosion applications.

Gray Phosphate

Gray phosphate provides a minimum level of corrosion resistance and is intended for dry, low corrosion applications.

Black Phosphate

Black phosphate provides a minimum level of corrosion resistance and is intended for dry, low corrosion applications.

Yellow Zinc

Electroplated zinc applied in accordance with ASTM F1941. In the ASTM B117 salt spray test, yellow zinc provides at least 24 hours of corrosion protection before the first appearance of red rust.

Class 1 Zinc Electroplate

Electroplated zinc applied in accordance with ASTM A641, Class 1. This is an electroplated zinc coating that provides a low level of corrosion resistance. The Class 1 coating has no specified red rust performance criteria in the B117 salt spray test.

Type 410 Stainless Steel

Type 410 stainless steel is a low-carbon martensitic grade of stainless steel that can be hardened and is inherently magnetic. This material provides corrosion resistance in mild atmospheres and many mild chemical environments.

Coated Zinc

This coating system consists of an electroplated zinc base layer with an E-Coat top coat. It provides corrosion resistance that is adequate for low corrosion environments. In ASTM B117 salt spray testing at 500 hours of exposure, fasteners with this coating have an average red rust of less than 5%.

Medium Level of Corrosion Resistance



Quik Guard® Coating

Quik Guard is a proprietary coating that consists of an electroplated zinc base layer and a system of organic top coats. It provides corrosion resistance equivalent to hot-dip galvanization (ASTM A153, Class D) in some exposures. In ASTM B117 salt spray testing at 1000 hours of exposure, fasteners with the Quik Guard coating have average red rust less than 2%.

Double-Barrier Coating

The Simpson Strong-Tie® Double Barrier coating is a proprietary coating that provides a level of corrosion resistance that is equivalent to hot-dip galvanization (ASTM A153, Class D) in most non-marine environments.

Class D Hot-Dip Galvanized, ASTM A153

The Class D hot-dip galvanization is a coating that meets the requirements of ASTM A153, Class D, which is a minimum average of 1.0 oz/ft² [305 g/m²] of zinc applied by a hot-dip process. Hot-dip galvanized fasteners are compliant with the 2012 and 2015 IBC and IRC.

Class 55 Mechanically Galvanized, ASTM B695

This is a mechanically-applied zinc coating that meets the requirements of ASTM B695, Class 55, which is a minimum average thickness of 55 microns with a supplementary overcoat. Screws with a Class 55 coating meet the requirements for use in preservative-treated and fire-retardant-treated wood as stated in the 2012 and 2015 IRC.

N2000® Mechanically Galvanized

This is a mechanically-applied proprietary zinc coating with a supplementary overcoat. In the ASTM B117 salt spray test at 1000 hours of exposure, fasteners with the N2000 coating exhibit average red rust less than 15%.

C-3 Mechanically Galvanized

A mechanically-applied coating that is zinc with a minimum of 20% tin in accordance with Australian Standard AS3566.2. In the ASTM B117 salt spray test at 1,000 hours of exposure, fasteners with the C3 coating exhibit average red rust of less than 2%.

Coatings and Materials

High Level of Corrosion Resistance



Types 304 and 305 Stainless Steel

Types 304 and 305 stainless steels are nickel-chromium austenitic grades of stainless steel. Types 304 and 305 stainless steels are not hardened by heat treatment and are inherently nonmagnetic.

They provide very good corrosion resistance and are suitable for use in many corrosive environments. Fasteners made from Types 304 and 305 stainless steels are compliant with the 2012 and 2015 IBC and IRC.

Passivation of Stainless-Steel Fasteners

Stainless steels are designed to naturally self-passivate by forming a chromium oxide layer. Corrosion resistance of some stainless-steel fasteners is enhanced by a post-fabrication passivation process. The passivation process uses an acid bath to strip free iron from the surface and an oxidizer to force conversion of the surface chromium to the oxide form.

Severe Level of Corrosion Resistance



Type 316 Stainless Steel

Type 316 stainless steel is a nickel-chromium austenitic grade of stainless steel with 2-3% Molybdenum. Type 316 stainless steel is not hardened by heat treatment and is inherently nonmagnetic. It provides a level of corrosion protection suitable for severe environments, especially environments with chlorides. Type 316 stainless steel fasteners are compliant with the 2012 and 2015 IBC and IRC.

Class C, Hot-Dip Galvanized, ASTM A153

Class C hot-dip galvanization is a coating that meets the requirements of ASTM A153, Class C, which is a minimum average of 1.25 oz/ft² [381 g/m²] of zinc applied by a hot-dip process. Hot-dip galvanized fasteners are compliant with the 2012 and 2015 IBC and IRC.

Copper

Copper wire used for the manufacture of fasteners is in compliance with the material specifications of ASTM F1667. Copper fasteners meet the requirements for use in preservative-treated and fire-retardant-treated wood as stated in the 2012 and 2015 IBC and IRC. Compatibility with proprietary wood treatment chemicals should be verified against applicable evaluation reports.

Silicon Bronze

Silicon bronze is a copper alloy with silicon as the alloying element. Silicon bronze fasteners meet the requirements for use in preservative-treated and fire-retardant treated wood as stated in the 2012 and 2015 IBC and IRC. Compatibility with proprietary wood treatment chemicals should be verified against applicable evaluation reports.

Passivation of Stainless-Steel Fasteners

Stainless steels are designed to naturally self-passivate by forming a chromium oxide layer. Corrosion resistance of some stainless-steel fasteners is enhanced by a post-fabrication passivation process. The passivation process uses an acid bath to strip free iron from the surface and an oxidizer to force conversion of the surface chromium to the oxide form.

General Note about Salt Spray Testing

Salt spray testing in accordance with ASTM B117 is not intended to represent real-world corrosion performance of fastener coatings. It should only be used for comparative evaluation between like products. Many variables may affect the outcome of the salt spray test such as base material, fastener features, coating and the material where it is installed.

Fastener Overview, Nails

Nail Sizes

The most common method used to represent nail sizes is the penny size, which is a length designation. The size is written with a number and the abbreviation “d” for “denarius” which is Latin for “penny.” While referring to penny size and type designations such as “box” or “common” is a typical method for calling out nails, it is more accurate and reduces potential confusion if the nail is called out by diameter and length.

Nail Penny Size Lengths

Nail Size	Length	
	in.	mm
2d	1.00	25.4
3d	1.25	31.7
4d	1.50	38.1
5d	1.75	44.4
6d	2.00	50.8
7d	2.25	57.1
8d	2.50	63.5
9d	2.75	69.8
10d	3.00	76.2
12d	3.25	82.5
16d	3.50	88.9
20d	4.00	101.6
30d	4.50	114.3
40d	5.00	127.0
50d	5.50	139.7
60d	6.00	152.4
70d	7.00	177.8

Steel Wire Gauge/Diameter

Gauge	in.	mm
3	0.259	6.57
4	0.238	6.05
6	0.203	5.16
8	0.162	4.12
9	0.148	3.76
10	0.131	3.33
11	0.120	3.05
12	0.113	2.85
13	0.092	2.34
14	0.083	2.11
15	0.072	1.83
16	0.065	1.65
18	0.049	1.25
23	0.026	0.66

1. Table based on Birmingham or Stub's Iron Wire Gauge.

Fastener Overview, Nails

Nail Types

Box: Bright, coated, plain-shank nail or regular stock steel with flat round head and medium diamond point. Shank diameter is smaller than common nails of the same penny weight.

Brads: A common term used for nails less than 1¼" in length with a head slightly larger than the shank. These nails can be easily concealed by countersinking below the work surface.

Casing: A wire nail with a head that is only slightly larger head than a finish nail, often used for flooring.

Common: Bright plain-shank nail of regular stock steel with flat round head and medium diamond point. Shank diameter is larger than box nails of the same penny size.

Connector: A wire nail with a concentric, full, round head and diamond point. The shank can be either deformed with annular rings or smooth.

Finishing: A wire nail with a head that is only slightly larger than the shank and medium diamond point. These nails can be easily concealed by countersinking below the work surface.

Post-Frame: A wire nail with a concentric, full, round head and 2.25 to 3 inches of shank length that is deformed with annular rings. The annular rings have over-shank diameter of 0.005 to 0.010 inch and the pitch is 20 rpi.

Roofing: A nail used for attaching paper or shingles to roof battens or sheathing; usually with a large flat head.

Roof Sheathing Ring-Shank: A wire nail with a concentric, full, round head and at least 1.5 inches of shank length deformed with annular rings. The annular rings have over-shank diameter of 0.005 to 0.012 inch and the pitch is 13 to 20 rpi.

Siding: A wire nail with a shank that is typically 0.099" or less in diameter and a smaller head than other nails of the same size to help conceal the fastener after installation.

Nail Shank Types

Smooth Shank: There are no deformations on the shank, making nails with a smooth shank the easiest to drive. Smooth shank nails offer the least pull-out resistance when compared with spiral and ring shanks.

Spiral Shank: A spiral "thread" on the shank causes the nail to spin during installation, creating a thread-like interlock with the wood, which increases withdrawal capacity. Spiral-shank nails are designed to drive easier into harder woods and dense materials while still providing increased withdrawal resistance.

Annular Ring Shank: Annular threads or "rings" are formed on the shank to increase withdrawal capacity. The "rings" create an interlock between the shank of the nail and the wood, providing superior holding power. Generally considered the nail type with the best withdrawal resistance.



Color Guide for PVC/Composite Decking

For current information regarding color matching, visit strongtie.com/deckcolormatch

Deck Board Series	Deck Board Color	Simpson Strong-Tie® Screw Color	
AZEK®			
Arbor®	Acacia	Brown 01	
	Brazilian Walnut	Brown 01 / Brown 02	
	Cobre	Tan 04	
	Hazelwood	Gray 03	
	Morado	Tan 01	
	Mountain Redwood	Red 01 / Red 02	
	Silver Oak	Brown 05	
Harvest®	Autumn Chestnut	Brown 05	
	Brownstone	Tan 02	
	Clay	Gray 03	
	Clay	Gray	
	Island Oak	Gray	
	Kona	Brown 01	
	Slate Gray	Gray 01	
Vintage Collection™	White	White 01	
	Cypress	Tan 03	
	Mahogany	Tan 01	
Dark Hickory	Gray 04		
	Deckorators		
	Classic	Gray	Gray 01
Cedar		Tan	
Redwood		Red 01	
Walnut		Tan 01	
Heritage	Milled Maple	Tan 02	
	Barrel-aged Oak	Brown 01	
Vault	Mesquite	Brown 05	
	Dusk	Gray	
Vista	Ashwood	Gray	
	Driftwood	Gray	
	Ironwood	Tan 01	
	Kingswood	Tan 01	
	Sandalwood	Tan	
Rosewood	Red 01		
Duralife™			
Landscapes Collection	Coastal Grey	Gray 01	
	Mahogany	Red 01	
	Pebble	Tan	
Hardwoods Collection	Brazilian Cherry	Red 01	
	Garapa Gray	Gray	
	Golden Teak	Tan 03	
	Tropical Walnut	Tan 01	
Evergrain® (by Tamko®)			
Envision®	Greywood	Gray	
	Rustic Walnut	Brown 01	
	Shaded Auburn	Red 01	
	Spiced Teak	Tan 01	
Evergrain® (Classic)	Cape Cod Grey	Gray	
	Cedar	Tan 03	
	Redwood	Red	
	Weathered Wood	Brown 01	

Deck Board Series	Deck Board Color	Simpson Strong-Tie® Screw Color
Fiberon®		
Horizon®	Castle Gray	Gray 01
	Greystone	Gray
	Ipe	Tan 03
	Rosewood	Red 01
	Tudor Brown	Brown 01
Sanctuary®	Earl Grey	Gray 04
	Latte	Gray 01
Espresso	Brown 01	
	Villa	Tan 03
Good Life™	Cabin	Tan 01
	Cottage	Gray
Paramount	Fossil	Tan 02
	Sandstone	Gray 01
	Flagstone	Gray 01
	Brownstone	Brown 05
Mineral	Gray 02	
	Chestnut	Tan 01
	Gray Birch	Gray
Western Cedar	Tan 03	
	MoistureShield®	
Essential Collection®	Cape Cod Gray	Gray
	Desert Sand	Tan 02
	Seasoned Mahogany	Red
	Tigerwood	Tan 01
Walnut	Brown 01	
	Java	Tan 03
Modernview	Amber	Tan 01
	Slate	Gray
	Auburn	Tan 01
MoistureShield® FR	Cape Cod Gray	Gray
	Earthtone	Gray 01
	Seasoned Mahogany	Red
MoistureShield Pro	Ipe	Brown 01
	Graystone	Gray
	Brazilian Chestnut	Red 01
Vantage Collection®	Cape Cod Gray	Gray
	Desert Sand	Tan 02
	Earthtone	Gray 01
	Rustic Cedar	Tan 03
	Seasoned Mahogany	Tan 01
	Tigerwood	Tan 01
	Bridle	Brown 05
	Walnut	Red 01

Color Guide for PVC/Composite Decking

For current information regarding color matching, visit strongtie.com/deckcolormatch

Deck Board Series	Deck Board Color	Simpson Strong-Tie® Screw Color
TimberTech®		
DockSider®	Cedar	Tan
	Gray	Gray or Gray 01
Earthwood Evolutions® Natural	Brick	Red 01
	Slate	Gray
	Brownstone	Tan 01
Earthwood Evolutions® Legacy	Brown Oak	Tan 01
	Mocha	Red 01
	Pecan	Tan 01
Earthwood Evolutions® Terrain	Tigerwood	Tan 01
	Ashwood	Gray 01
	Rustic Elm	Brown 01
ReliaBoard®	Stone Ash	Gray
	Silver Maple	Gray
	Sandy Birch	Tan 02
Tropical	Cedar	Tan
	Gray	Gray / Gray 01
TwinFinish®	Amazon Mist	Gray 04
	Antique Palm	Tan 01
	Antiqua Gold	Tan 03
	Caribbean Redwood	Red 01
Trex®	Cedar	Tan
	Grey	Gray or Gray 01
	Redwood	Red
Select®	Pebble Grey	Gray
	Madeira	Red
	Saddle/Barrel	Tan 01
	Woodland Brown	Brown 01
	Flint/New Winchester Grey	Gray 04
Enhance®	Beach Dune	Brown 05
	Clam Shell	Gray
Transcend®	Firepit	Red 01
	Tiki Torch	Tan 03
	Gravel Path	Gray 01
	Lava Rock	Red 01
	Rope Swing	Tan 02
	Spiced Rum	Tan 01
	Tree House	Tan 01
	Vintage Lantern	Brown 01
	Island Mist	Gray
Havana Gold	Tan 01	
Escapes®	Acorn	Brown 05
	Sahara	Tan 02
	Pewter	Gray



General Information

Fastener Overview, Screw Features

General Information

Head Styles

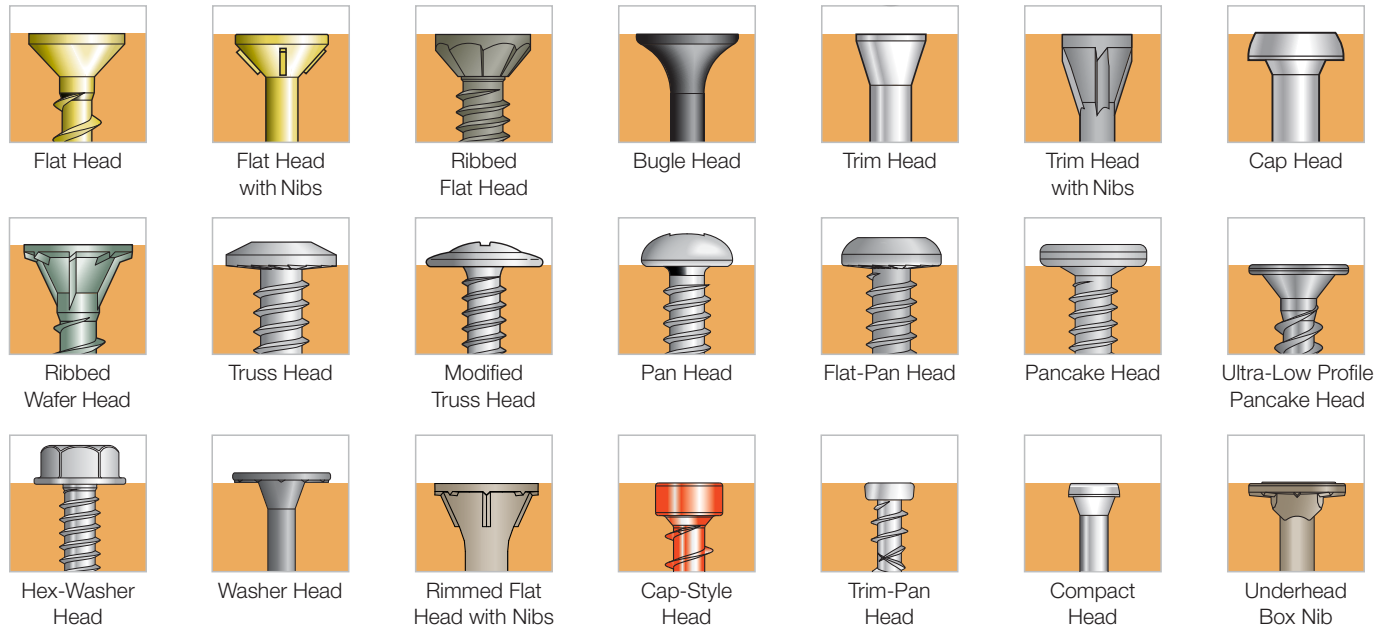

Thread Styles

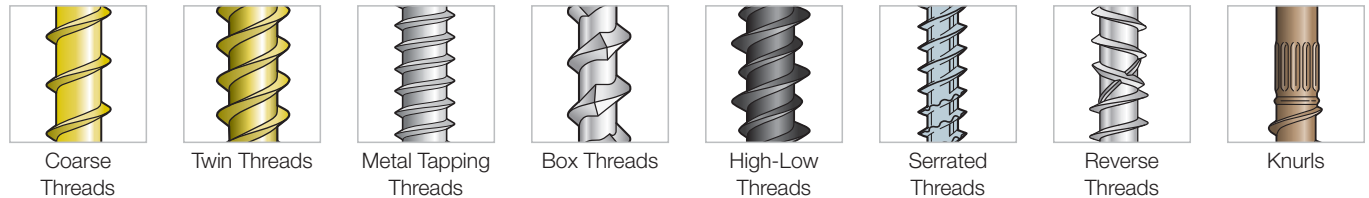

Point Styles

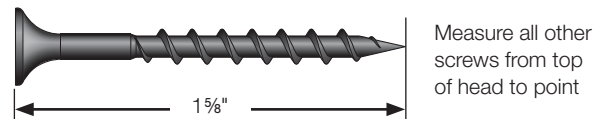
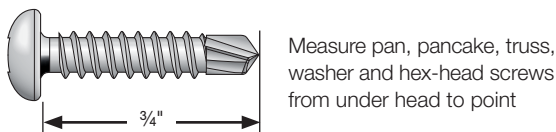
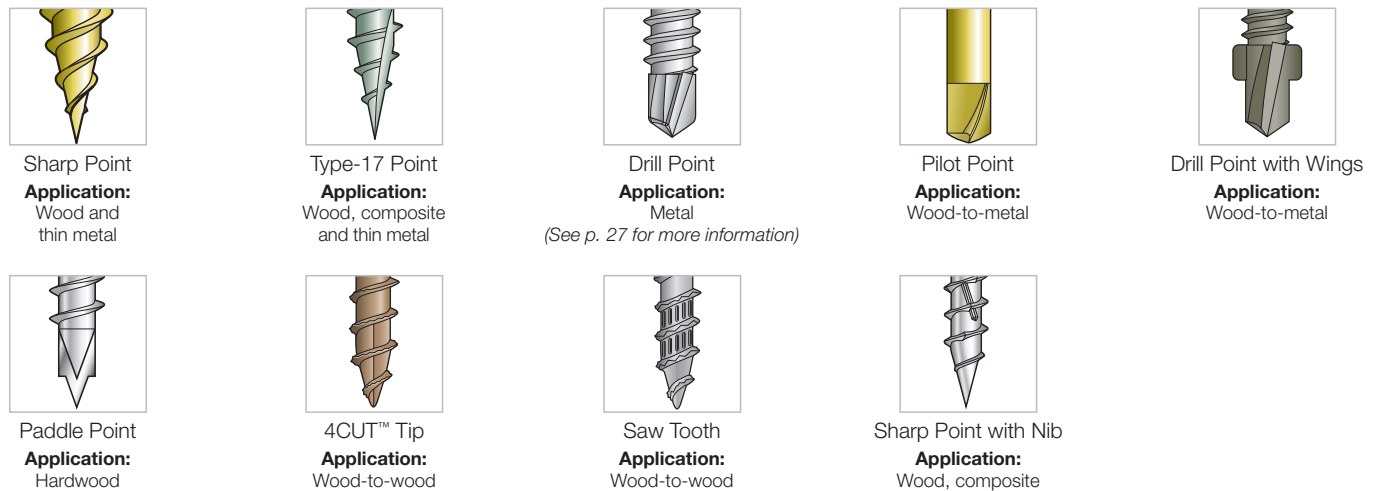

How Self-Drilling Screws Work

Application

As their name implies, self-drilling screws operate on the same principles as drill bits and other cutting tools. For any cutting tool, performance is governed by cutting speed, feed rate, depth of cut and the work material itself. Then, installation performance of self-drilling screws can be linked to the basic cutting tool parameters where suggested optimal parameter values are listed by nominal screw size in the table.

Point Geometry is the designed shape of the screw's drill point and not directly adjustable by the user.

RPM is the speed at which the driver motor runs while the screw is installed. This is often adjustable using a variable pull trigger or different driver motor.

Applied Force is a measure of the user applied force as the screw is installed. More force is not necessarily better.

Work Material Hardness can be viewed as a material's resistance to drilling or cutting. In most instances, the harder the work material, the more difficult it is to cut. Depending on the application, this may be outside the user's control.

Optimal Cutting Conditions by Screw Size

Screw Size	Major Diameter (in.)	RPM*	Applied Force* (lb.)	Work Material Hardness*
#6	0.138	2,200	80	20 Rockwell "C"-scale
#8	0.164	1,900	93	
#10	0.190	1,600	104	
#12	0.216	1,400	116	
#14	0.250	1,200	131	
#16	0.313	1,000	157	

* Suggested combined maximum values. Individual values may be increased if other, associated variables are decreased proportionally. Stated speeds may require a variable-speed screwdriver motor and a partial trigger-pull.

Special Considerations

Drill-Point Material is generally plain carbon steel which is less stable at high temperatures than equivalent high-speed steel (HSS) drill-bits. To reduce wear on the drill point, fasten using a drill motor rather than an impact driver or hammer drill.

High Temperature Stability affects how quickly the drill point fails due to the heat generated by the drilling operation. Refer to the troubleshooting guide at the end of this section for some visual examples.

Drilling Temperature is directly proportional to motor RPM, applied force, and work material hardness. As each value increases, so does the heat generated by the drilling operation.

Reducing Applied Force can increase durability and allow the drill point to penetrate thicker materials (i.e., remove more material before failing due to heat buildup).

Reducing Motor RPM can improve performance in harder materials by allowing the user to push harder during the drilling process and extending the life of the drill point.

Design Features

When selecting a self-drilling screw, consider the material thicknesses and types of materials to be joined. Following are some key design features to look for when selecting suitable fasteners.

Drill Flutes allow drilled material to exit the hole. Completely embedded flutes can no longer remove these chips, which contain approximately 80% of the heat created by the drilling process. A buildup of this material can cause the point to over-heat and fail.

Point Length determines the material thickness which the screw can reliably penetrate. The unthreaded portion of the point, (pilot section) must be able to completely drill through the material before the threads engage. If the threads engage before drilling is complete, the fastener can bind and break.

Point Wings are used on some screws that fasten thicker materials, such as wood, to metal. The wings enlarge the hole in the fastened material, allowing the threads to pass through without contacting the fastened material. This added clearance prevents separation of the fastened material from the base metal (known as "jacking"). The wings will break away on contact with the metal before the threads engage in the metal.

Basic Self-Drilling Screw Anatomy

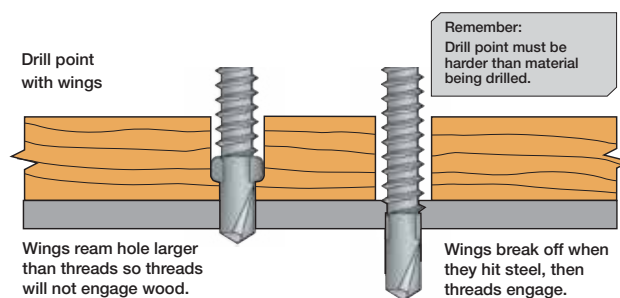
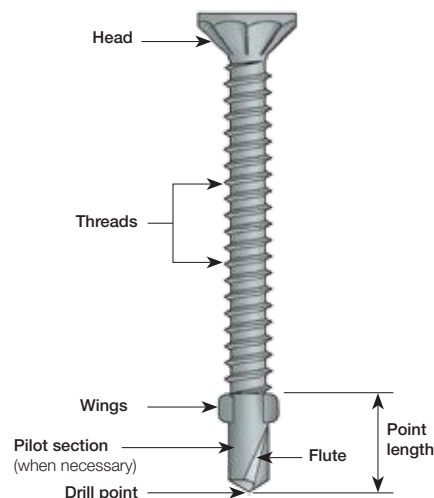

How Self-Drilling Screws Work

General Information

Work Material Thickness by Screw

Screw Point Type	Screw Size	Suitable Material Thickness ¹ (in.)
#2	#6	0.035 – 0.100
	#8	0.035 – 0.100
	#10	0.035 – 0.100
#3	#8	0.100 – 0.140
	#10	0.110 – 0.175
	#12	0.110 – 0.210
	#14	0.110 – 0.220
#4	#12	0.175 – 0.250
	#14	0.175 – 0.250
#5	#14	0.250 – 0.500

1. Total thickness of all steel, including any spacing between layers.

Cold-Formed Steel Thicknesses for Framing Applications

Gauge ¹	Mil ²	Design Thickness		Minimum Thickness	
		(in.)	(mm)	(in.)	(mm)
25	18	0.0188	0.48	0.0179	0.45
22	27	0.0283	0.72	0.0269	0.68
20 (Drywall)	30	0.0312	0.79	0.0296	0.75
20 (Structural)	33	0.0346	0.88	0.0329	0.83
18	43	0.0451	1.15	0.0428	1.09
16	54	0.0566	1.44	0.0538	1.37
14	68	0.0713	1.81	0.0677	1.72
12	97	0.1017	2.58	0.0966	2.45

1. For reference only.

2. One "mil" is 1/1,000 (0.001) of an inch. Mil thickness measures the uncoated base material.

Self-Drilling Screw Troubleshooting Guide

Failure Mode	Likely Cause(s)	Suggested Action
<p>Split at point (web)</p> 	Excessive force (feed) applied while drilling	Reduce application force
<p>Outer corners worn or melted</p> 	Drill RPM (cutting speed) too high	Use slower motor or partial trigger pull
<p>Cutting edges chipping or breaking</p> 	Excessive force (feed) applied while drilling	Reduce application force
<p>Point melted or diameter significantly reduced</p> 	<ul style="list-style-type: none"> Work material too hard Insufficient chip clearance Excessive force (feed) applied while drilling 	<ul style="list-style-type: none"> Confirm work material specs Choose screw with longer pilot section Reduce application force
<p>Screw spins without drilling a hole</p> 	<ul style="list-style-type: none"> Drill motor set on reverse Work material too hard Drill point blunted by handling 	<ul style="list-style-type: none"> Check motor direction Confirm work material specs Inspect unused drill points for possible damage (from handling)

Custom-Order Nails

We Make Nails To Your Specification

Simpson Strong-Tie is proud to be one of the last remaining manufacturers of stainless-steel and copper-alloy nails in the United States. While we specialize in AISI-Type 316 and 304 stainless steel, aluminum, brass, commercial bronze, copper and silicon bronze, exotic alloys pose no problem — provided their mechanical properties are within our manufacturing capabilities. To further help our customers, we employ a “Cut Close, Ship All” fulfillment methodology. Call Simpson Strong-Tie for details, and visit strongtie.com to download worksheet T-NAIL-WS11 which provides the necessary information. See p. 135 for custom-order nail worksheet.



Custom Color Matching

Simpson Strong-Tie offers fasteners in a variety of stock colors to match popular construction materials such as cedar and redwood lumber, major brands of composite decking and siding/trim material. Custom color matching is also available to match virtually any material. Material samples or a Pantone® color number are required and 3–4 week lead times are standard. Call Simpson Strong-Tie for details.





Quik Drive® PRO300S

**Built to withstand
the elements.**

Deck-Drive™ DWP WOOD SS Screw



Performance Products

Performance Products

Strong-Drive® Structural Fasteners	32
Deck-Drive™ Premium Deck Screws	34
Quik Drive® Auto-Feed Screw Driving Systems	36
Stainless-Steel Products	38

Strong-Drive® Structural Fasteners

Performance Products



Screws

SDWS TIMBER Screw

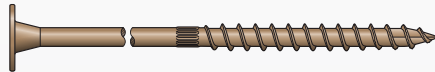

P. 69

SDWS FRAMING Screw



P. 68

SDWH TIMBER-HEX Screw



P. 70

SDWH TIMBER-HEX HDG Screw



P. 72

SDWH TIMBER-HEX SS Screw



P. 71

SDS HEAVY-DUTY CONNECTOR Screw

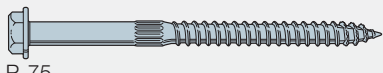

P. 75

SD CONNECTOR Screw

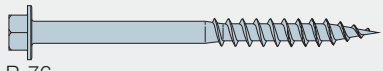

P. 76

SDWC TRUSS Screw

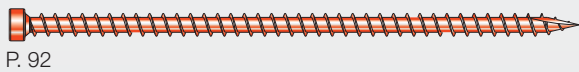

P. 92

SDW EWP-PLY Screw



P. 93

SDW TRUSS-PLY Screw



P. 94

SDWS LOG Screw



P. 94

SDWF FLOOR-TO-FLOOR Screw



P. 95

SDWV SOLE-TO-RIM Screw

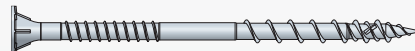

P. 95

WSNTL SUBFLOOR Screw



P. 96

TB WOOD-TO-STEEL Screw



P. 100

XL LARGE-HEAD METAL Screw

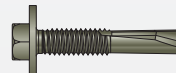

P. 97

XM MEDIUM-HEAD METAL Screw



P. 97

SELF-DRILLING X METAL Screw



P. 98

XE EXTERIOR STRUCTURAL METAL Screw

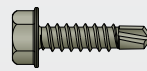

P. 98

PPSD SHEATHING-TO-CFS Screw



P. 101

FPHSD FRAMING-TO-CFS Screw

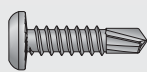

P. 102

Strong-Drive® Structural Fasteners

Nails

SCNR **RING-SHANK CONNECTOR** Nail



P. 138

SCN **SMOOTH-SHANK CONNECTOR** Nail



P. 139

33° SCNR **RING-SHANK CONNECTOR** Nail (collated)

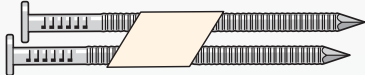

P. 159

33° SCN **SMOOTH-SHANK CONNECTOR** Nail (collated)

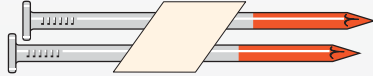

P. 158

Collated for Quik Drive®

WSNTL **SUBFLOOR** Screw



Pp. 268-269

WSV **SUBFLOOR** Screw



P. 267

TB **WOOD-TO-STEEL** Screw



P. 274

PHSD **FRAMING-TO-CFS** Screw



P. 275

FPHSD **FRAMING-TO-CFS** Screw



P. 275

PPSD **SHEATHING-TO-CFS** Screw



P. 276

XL **LARGE-HEAD METAL** Screw



P. 277

XM **MEDIUM-HEAD METAL** Screw

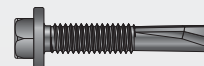

P. 277

SELF-DRILLING X METAL Screw



P. 278

Deck-Drive™ Premium Deck Screws

Performance Products



Hand Drive

DSV **WOOD** Screw

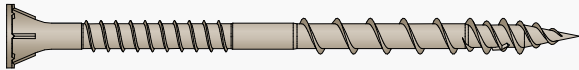

P. 78

DWP **WOOD SS** Screw

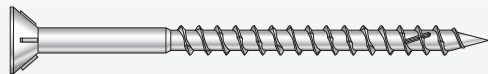

Pp. 79–81

DHPD **HARDWOOD** Screw

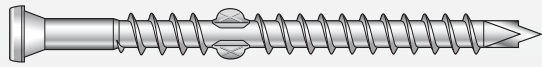

P. 82

DCU **COMPOSITE** Screw

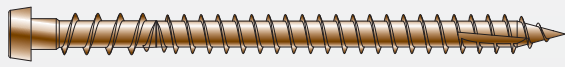

Pp. 89–90



Deck-Drive™ Premium Deck Screws

Collated for Quik Drive®

DSV **WOOD** Screw

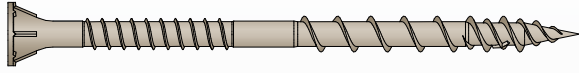

P. 256

DWP **WOOD SS** Screw

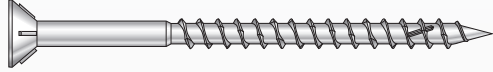

P. 257

DHPD **HARDWOOD** Screw

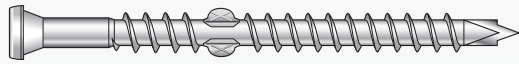

P. 257

DCU **COMPOSITE** Screw

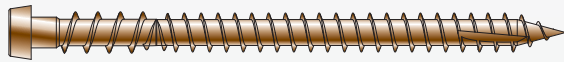

P. 265

DCSD **COMPOSITE-TO-STEEL** Screw



P. 266



Quik Drive® Auto-Feed Screw Driving Systems

Performance Products



Systems

PRO200 Drywall System



P. 220

PRO200S Multipurpose System



P. 221

PRO250 Subfloor System



P. 222

PRO300S Decking System



P. 223

PRO300SRF Tile Roofing System



P. 229

PRORF Tile Roofing System



P. 228

PROHSD60 Wood-to-Steel System



P. 224

PROHSD75 Wood-to-Steel System



P. 225

PROHX14 Metal Roofing/Siding System



P. 226

BGP300 Metal Roofing/Siding System



P. 219

PROLDH Underlayment/Backerboard System



P. 227

BSD200 Structural Steel Decking System



P. 218

PROSDX150 Steel-Decking System



P. 230

PROPP150 Metal Roofing System



P. 231

Combo Systems

PROSDD Multi-Purpose Combo System



P. 232

PROCCS+ Multi-Purpose Combo System



P. 233

PROGCB Underlayment/Backerboard Combo System



P. 234

C-F-2017 © 2017 SIMPSON STRONG-TIE COMPANY INC.

Quik Drive® Auto-Feed Screw Driving Systems

Attachments

PRO200 Drywall Attachment



P. 236

PRO200S Multi-Purpose Attachment



P. 236

PRO250 Subfloor Attachment



P. 237

PRO250DW Drywall Attachment



P. 237

PRO300S Decking Attachment



P. 238

BSD200 Structural Steel Decking Attachment



P. 235

PROHSD60 Wood-to-Steel Fastening Attachment



P. 238

PROHSD75 Wood-to-Steel Fastening Attachment



P. 239

PROHX14 Metal Roofing/Siding Attachment



P. 239

PROHX516 Steel-to-Steel Fastening Attachment



P. 240

PROLDH Underlayment/Backerboard Attachment



P. 240

PROPH Cold-Formed Steel Framing Attachment



P. 241

PROPP150 Metal Roofing Attachment



P. 243

PRO300SRF Tile Roofing Attachment



P. 242

PRORF Tile Roofing Attachment



P. 241

PROSDX150 Steel-Decking Attachment



P. 242

BGP300 Metal Roofing/Siding Attachment



P. 235

Stainless-Steel Fasteners

Performance Products

Stainless-Steel FASTENERS

Screws

Strong-Drive®
SDWH **TIMBER HEX SS** Screw

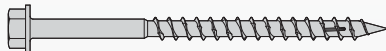

P. 71

Deck-Drive™
DCU **COMPOSITE SS** Screw

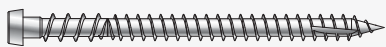

P. 90

Deck-Drive™
DWP **WOOD SS** Screw



Pp. 79–81

Bugle-Head Wood Screw: 6-Lobe Drive

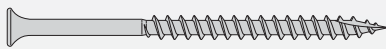

P. 83

Bugle-Head Wood Screw: Square Drive

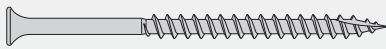

Pp. 84–85

Trim-Head Screw: Square Drive

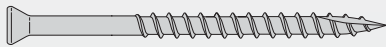

P. 86

Trim-Head Screw: 6-Lobe Drive

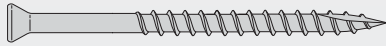

Pp. 87–88

Nails

Strong-Drive®
SCNR **RING-SHANK CONNECTOR** Nail



P. 138

Premium Siding Nail



P. 114

Premium Common Nail



P. 114

Box Nail – Annular Ring Shank



P. 115

Cedar and Redwood Decking Nail



P. 116

Wood Siding Nail



P. 117

Common Nail – Annular Ring Shank



P. 118

Common Nail – Smooth Shank

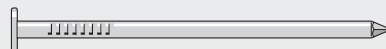

P. 119

Fiber-Cement Siding Nail



P. 120

Finishing Nail



P. 121

Nail with EPDM Washer –
Annular Ring Shank



P. 122

Preservative-Treated
Wood Decking Nail



P. 124

Pyramid-Head Nail



P. 125

Roofing Nail – Annular Ring Shank



P. 130

Painted Siding Nail



P. 126

Post and Beam Nail – Annular Ring Shank



P. 123

Note: Non-stock items are special orders and may be subject to minimum order quantities and longer lead times.

Stainless-Steel Fasteners

Roofing Nail – Smooth Shank



P. 132

Shake and Shingle Siding/Roofing Nail



P. 128

Tile/Slating Nail – Annular Ring Shank

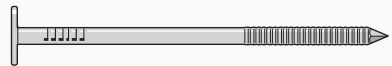

P. 133

Tile/Slating Nail – Smooth Shank



P. 134

Washed Roofing Nail



P. 129

Specialty

Escutcheon Pins



P. 140

Fencing Staples

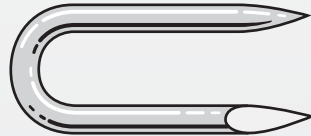

P. 141

Fiber-Cement Screw



P. 145

Metal Panel Screw

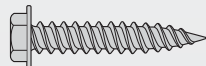

P. 146

Metal Panel Screw with EPDM Washer

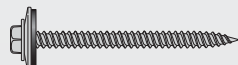

P. 146

Hog Ring – #3 Pre-Bent, Hill Pattern



P. 141

Marine Screw – Pan Head



P. 142

Marine Screw – Flat Head



P. 143

Pocket-Hole Screw

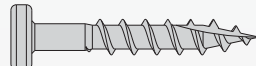

P. 152

Washers for Nail and Screw Assemblies



P. 153

Storm-Panel Screw

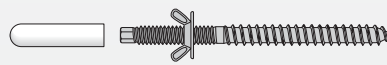

P. 152

Trim-Head Screw with Sealing Washer

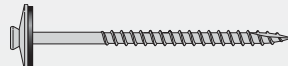

P. 150

Truss-Head Screw

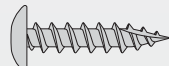

P. 151

Wire-Lath Modified Truss-Head Screw



P. 151

Inserted Plastic-Coil Nails

0° Inserted Plastic Coil, Full Round Head, Ring-Shank Nail



P. 160

15° Inserted Plastic Coil, Full Round Head, Ring-Shank Nail



P. 161

Wire-Coil Nails

15° Wire Coil, Full Round Head Ring-Shank Siding Nail



P. 163

15° Wire Coil, Painted Full Round Head, Ring-Shank Nail



P. 164

15° Wire Coil, Full Round Head, Ring-Shank Roofing Nail



P. 165

Stainless-Steel Fasteners

Performance Products

15° Wire Coil, Full Round Head, Smooth-Shank Roofing Nail



P. 166

15° Wire Coil, Full Round Head, Ring-Shank Decking/Framing Nail



P. 167

15° Wire Coil, Painted Full Round Head Ring-Shank Decking/Framing Nail



P. 168

20°–22° Plastic Strip, Full Round Head, Screw-Shank Nail



P. 171

20°–22° Plastic Strip, Full Round Head, Smooth-Shank Nail

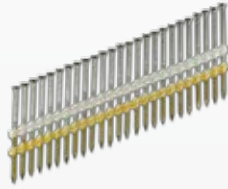

P. 172

31°–34° Plastic Strip, Full Round Head, Ring-Shank Nail



P. 173

Tape Collation, DA-Style Angle, 15-Gauge Finishing Nail



P. 180

Adhesive Collation Nails

20° Angle Adhesive Collation, T-Style Head, 16-Gauge Finishing Nail



P. 176

25° Angle Adhesive Collation, FN-Style, 15-Gauge Finishing Nail



P. 176

Straight, Adhesive Collation, T-Style Head 16-Gauge Finishing Nail



P. 177

Plastic-Strip Nails

20°–22° Plastic Strip, Casing Head, Ring-Shank Nail

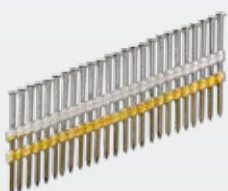

P. 169

20°–22° Plastic Strip, Full Round Head, Ring-Shank Nail

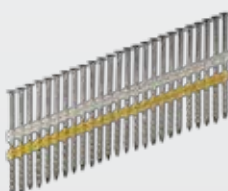

P. 170

Paper-Tape Nails

31°–34° Paper Tape, Clipped Head, Ring-Shank Nail

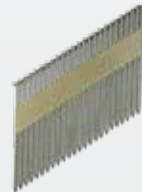

P. 175

Strong-Drive® 33° SCNR **RING-SHANK CONNECTOR** Nail

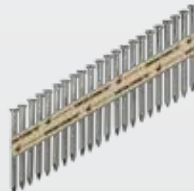

P. 159

Note: Non-stock items are special orders and may be subject to minimum order quantities and longer lead times.

Stainless-Steel Fasteners

Straight, Adhesive Collation
T-Style Head, 18-Gauge Finishing Nail



P. 178

Straight, Adhesive Collation
23-Gauge Micro Pins



P. 179

Specialty

L Series Flooring Cleats

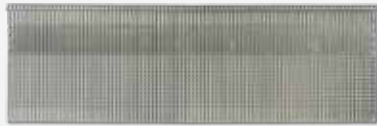

P. 181

T Series Flooring Cleats



P. 181

Collated Staples

½" Crown, 15 ½-Gauge Staples
(Similar to Bostitch® BCS Series)



P. 182

1" Crown, 16-Gauge Staples
(Similar to Senco® P Series)



P. 182

½" Crown, 16-Gauge Staples
(Similar to Paslode® GS Series)



P. 183

¼" Crown, 18-Gauge Staples
(Similar to Senco® L Series)



P. 184

⅞" Crown, 16-Gauge Staples
(Similar to Senco® N Series)

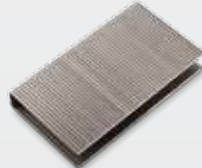

P. 185

Collated Screws for the Quik Drive® System

Deck-Drive™
DCU **COMPOSITE SS** Screw

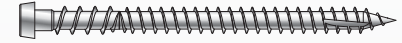

P. 265

Deck-Drive™
DWP **WOOD SS** Screw



P. 257

Trim-Head Screw: Sharp Point



P. 258

Bugle-Head Wood Screw



P. 259

SSWSCB Roofing Tile Screw



P. 264



**Precision engineered
to meet any demand.**

Strong-Drive® SDWS FRAMING Screw



Fastener Application Guide



- Decks, Docks and Boardwalks44
- Subfloor and Sheathing Applications46
- Underlayment and Backerboard Applications47
- Siding on Wood and Steel48
- Roofing50
- Wood Framing52
- Fasteners for Simpson Strong-Tie® Connectors54
- Finishing, Millwork and Trim55
- Fastening to Metal56
- Fencing58
- Cooling Towers60
- Log Homes62
- Steel Decking62
- Truss-Ply Fastening Applications63
- Drywall and Exterior Gypsum Sheathing Applications63
- Crating64
- Boat Building / Marine Trade65

Decks, Docks and Boardwalks



Screws, Nails and Specialty

Strong-Drive®
SDWS **FRAMING** Screw



Flat head with box nibs, Quik Guard® coating, p. 68

Strong-Drive®
SDWS **TIMBER** Screw



Washer head, double-barrier coating, p. 69

Strong-Drive®
SDWH **TIMBER-HEX** Screw



Hex-washer head, double-barrier coating, p. 70

Strong-Drive®
SDWH **TIMBER-HEX SS** Screw

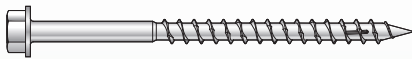

Hex head, Type 316 stainless steel, p. 71

Strong-Drive®
SDWH **TIMBER-HEX HDG** Screw

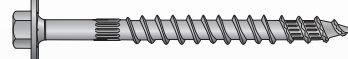

Hex-washer head, Class C, hot-dip galvanized, p. 72

Deck-Drive™
DSV **WOOD** Screw

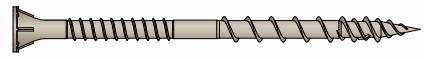

Rimmed flat head with nibs, Quik Guard® coating, p. 78

Deck-Drive™
DWP **WOOD SS** Screw



Flat with nibs and trim heads, Types 316 and 305 stainless steel, p. 79; painted head, Types 316 and 305 stainless steel, p. 81

Deck-Drive™
DHPD **HARDWOOD** Screw

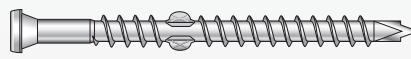

Cap head, Type 305 stainless steel, p. 82

Deck-Drive™
DCU **COMPOSITE** Screw

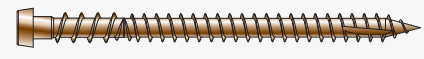

Cap head, Types 316 and 305 stainless steel, Quik Guard® coating, p. 89

Dexxter™
Composite-Decking Screw



Trim-pan head, Types 316 and 305 stainless steel, p. 91

Trim-Head Screw



Trim head, Types 316 and 305 stainless steel, pp. 86, 88; painted head, Types 316 and 305 stainless steel, p. 87

Bugle-Head Wood Screw

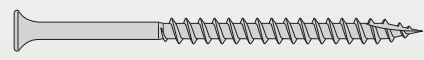

Bugle head, Types 316 and 305 stainless steel, pp. 83–85

Cedar Redwood
Decking Nail



Types 316 and 304 stainless steel, p. 116

Preservative-Treated
Wood Decking Nail



Types 316 and 304 stainless steel, p. 124

EB-TY® Hidden Deck Fastening System™



p. 154

Decks, Docks and Boardwalks

Collated Nails

20°–22° Plastic Strip, Full Round Head, Ring-Shank Nail



Types 316 and 304 stainless steel and silicon bronze, p. 170

20°–22° Plastic Strip, Full Round Head, Screw-Shank Nail

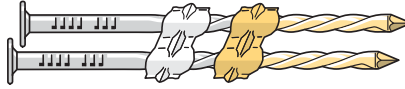

Types 316 and 304 stainless steel, p. 171

20°–22° Plastic Strip, Casing Head, Ring-Shank Nail



Type 304 stainless steel, p. 169

31°–34° Plastic Strip, Full Round Head, Ring-Shank Nail

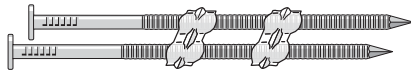

Types 316 and 304 stainless steel and silicon bronze, p. 173

31°–34° Paper Tape, Clipped Head, Ring-Shank Nail

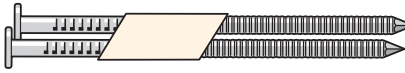

Types 316 and 304 stainless steel, p. 175

28° Wire Weld, Clipped Head, Ring-Shank Nail



Type 304 stainless steel, p. 174

15° Wire Coil, Full Round Head, Ring-Shank Nail

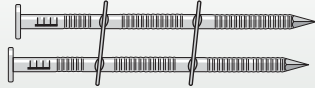

Types 316 and 304 stainless steel, p. 167

Collated Screws for the *Quik Drive*® System

Deck-Drive™
DSV **WOOD** Screw



Rimmed flat head with nibs, Quik Guard® coating, p. 256

Deck-Drive™
DWP **WOOD SS** Screw



Flat head, Types 316 and 305 stainless steel, p. 257

Deck-Drive™
DHPD **HARDWOOD** Screw

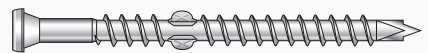

Cap head, Type 305 stainless steel, #10 compact head, p. 257

Deck-Drive™
DCSD **COMPOSITE-TO-STEEL** Screw



Cap head, Quik Guard® coating, p. 266

Deck-Drive™
DCU **COMPOSITE** Screw

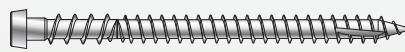

Cap head, Types 316 and 305 stainless steel, Quik Guard® coating p. 265

Trim-Head Screw: Type-17 Point

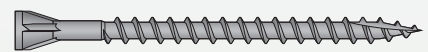

Trim head, Quik Guard® coating, p. 259

Trim-Head Screw: Sharp Point



Trim head, Types 316 and 305 stainless steel, p. 258

Bugle-Head Wood Screw

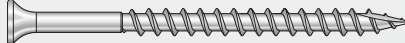

Bugle head, Types 316 and 305 stainless steel, p. 259

Subfloor and Sheathing Applications

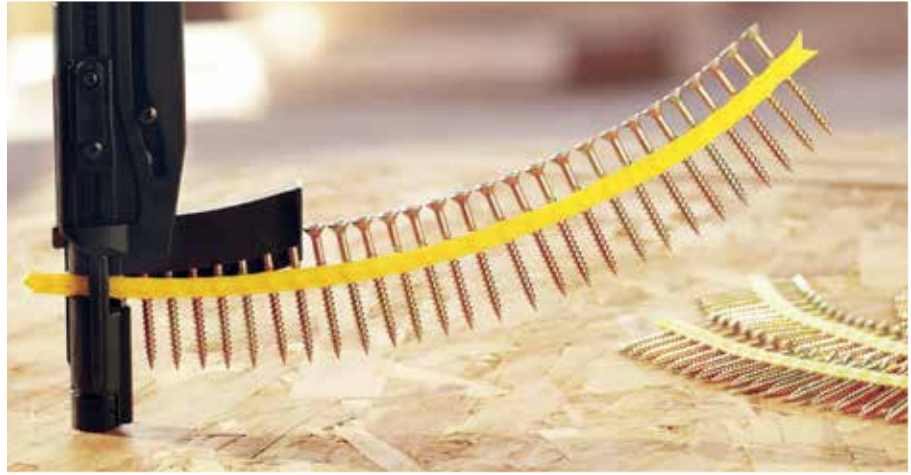

Screws

Strong-Drive®
WSNTL **SUBFLOOR** Screw



Wood-to-wood applications, yellow zinc coating, twin thread, p. 96

Strong-Drive®
PPSD **SHEATHING-TO-CFS** Screw



Wood-to-steel applications, #2 drill point, Quik Guard® or yellow zinc coating, p. 101

Strong-Drive®
TB **WOOD-TO-STEEL** Screw



#4 drill point, black phosphate, mechanically galvanized coating, p. 100

Collated Screws for the *QuikDrive*® System

Strong-Drive®
WSNTL **SUBFLOOR** Screw



Wood-to-wood applications, yellow zinc coating, twin thread, p. 268

Strong-Drive®
WSV **SUBFLOOR** Screw



Wood-to-wood applications, yellow zinc coating, p. 267

WSHL
Subfloor Screw



Wood-to-wood applications, gray phosphate coating, high-low threads, p. 270

Strong-Drive®
PPSD **SHEATHING-TO-CFS** Screw



Wood-to-steel applications, #2 drill point, Quik Guard® or yellow zinc coating, p. 276

WSC
Wood Screw



Wood-to-wood applications, yellow zinc coating, coarse thread, p. 273

CBSDQ
Sheathing-to-CFS Screw

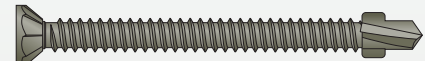

Sheathing to cold-formed steel, QuikGuard® coating, p. 281

Strong-Drive®
TB **WOOD-TO-STEEL** Screw

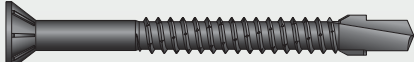

#4 drill point, black phosphate, yellow zinc, mechanically galvanized coating, p. 274

Underlayment and Backerboard Applications



Screws

Cement Board Screw

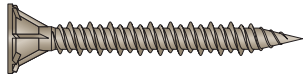

Cement board, multilayer coating, p. 145

MTH Underlayment Screw



Wood underlayment, gray phosphate, p. 96

Collated Screws for the *QuikDrive*® System

CB3BLG

Fiber-Cement Board Screw

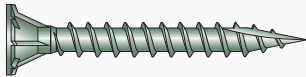

Cement board, C-3 mechanically galvanized coating, meets ANSI standards, p. 260

CB3BLGHL

Cement-Board Screw



Fiber-cement board, C-3 mechanically galvanized coating, p. 260

MTH

Wood Underlayment Screw



Wood underlayment, gray phosphate or yellow zinc coating, p. 271

DWF

Drywall-to-CFS Screw



Gypsum panel to steel, gray phosphate coating, p. 282

DWFSD

Drywall-to-CFS Screw



Gypsum panel to steel, yellow zinc coating, p. 282

DWC

Drywall Screw



Gypsum panel to wood, gray phosphate, yellow zinc or N2000 galvanized coating, p. 270

Siding on Wood and Steel



Screws and Nails

Metal-Panel Screw

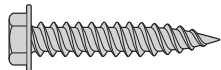

Washer head, Type 316 stainless steel, p. 146

Metal-Panel Screw with EPDM Washer



Type 316 stainless steel, p. 146

Wire-Lathe Modified Truss-Head Screw



Type 305 stainless steel, p. 151

Fiber-Cement Screw

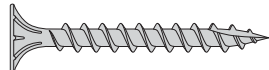

Type 316 stainless steel, p. 145

Self-Drilling Fiber-Cement Screw

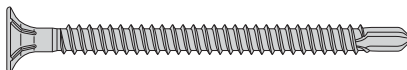

Type 410 stainless steel, p. 106

Self-Drilling Siding Screw

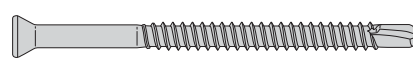

Type 410 stainless steel, p. 108

Self-Drilling Wire-Lath Modified Truss-Head Screw

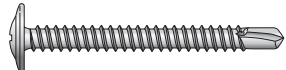

Type 410 stainless steel, p. 110

Wood Siding Nail



Types 316 and 304 stainless steel, p. 117

Shake and Shingle Siding/Roofing Nail



Types 316 and 304 stainless steel, p. 128

Painted Siding Nail



Types 316 and 304 stainless steel, p. 126

Fiber-Cement Siding Nail



Type 316 stainless steel, p. 120

Pyramid-Head Nail



Type 316 stainless steel and silicone bronze, p. 125

Nail with EPDM Washer



Types 316 and 304 stainless steel, p. 122

Siding on Wood and Steel

Collated Nails and Staples

15° Wire Coil, Full Round Head, Ring-Shank Nail

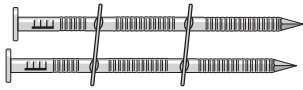

Types 316 and 304 stainless steel, p. 163

15° Wire Coil, Painted, Full Round Head, Ring-Shank Nail

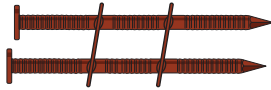

Type 304 stainless steel, p. 168

0° and 15° Inserted Plastic Coil, Full Round Checkered Head, Ring-Shank Nail

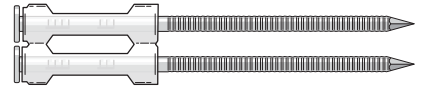

Types 316 and 304 stainless steel, aluminum, pp. 160, 161

7/16" Crown, 16 Gauge Staple

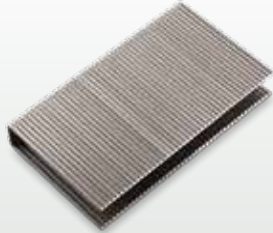

Types 316 and 304 stainless steel, p. 185

1/2" Crown, 16 Gauge Staple

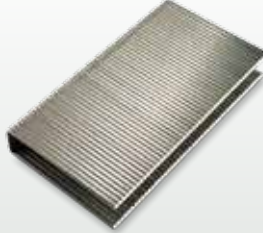

Types 316 and 304 stainless steel, p. 183

Collated Screws for the *QuikDrive*® System

CBSDQ
Sheathing-to-CFS Screw

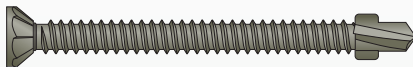

#2 drill point, Quik Guard® coating, p. 281

CB3BLG
Fiber-Cement Board Screw

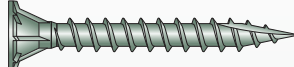

C-3 galvanized coating, p. 260

CB3BLGHL
Cement-Board Screw



C-3 galvanized coating, p. 260

Roofing



Screws and Nails

Shake and Shingle Siding/Roofing Nail



Types 316 and 304 stainless steel, p. 128

Roofing, Tile and Slating Nail



Types 316 and 304 stainless steel, copper and aluminum, pp. 130-134

Washed Roofing Nail



Type 304 stainless steel, p. 129

Nail with EPDM Washer



Types 316 and 304 stainless steel, p. 122

Metal-Panel Screw

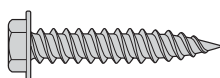

Washer head, Type 316 stainless steel, p. 146

Metal-Panel Screw with EPDM Washer



Type 316 stainless steel, p. 146

Pancake-Head Screw

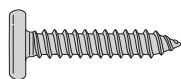

Type 410 stainless steel, p. 149

Self-Drilling Pancake-Head Screw

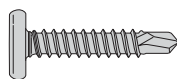

Type 410 stainless steel, p. 149

Strong-Drive®
SELF-DRILLING X METAL Screw

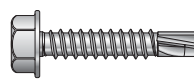

5/16" hex head, Quik Guard® and clear zinc coating, p. 98

Roofing

Collated Nails and Staples

15° Wire Coil, Full Round Head, Smooth-Shank Roofing Nail

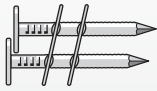

Types 316 and 304 stainless steel, p. 166

15° Wire Coil, Full Round Head, Ring-Shank Roofing Nail

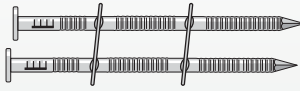

Types 316 and 304 stainless steel, p. 165

7/16" Crown, 16-Gauge Staple

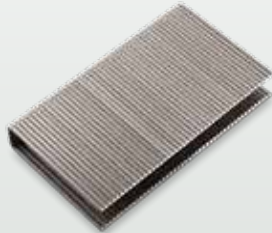

Types 316 and 304 stainless steel, p. 185

1/2" Crown, 16-Gauge Staple

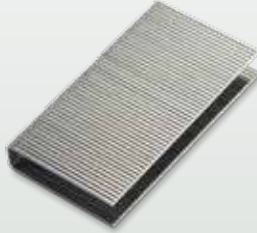

Type 316 stainless steel, p. 183

Collated Screws for the *QuikDrive*® System

PCSD Standing-Seam-Roofing Panel Clip Screw

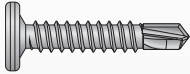

#3 drill point, clear zinc or Quik Guard® coating and Type 410 stainless steel, p. 280

PC Standing-Seam-Roofing Panel Clip Screw

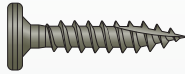

Type-17 point, clear zinc or Quik Guard® coating and Type 410 stainless steel, pp. 263, 272

HJ Metal Roofing/Siding Panel Screw



Type 305 stainless steel, p. 261

HG Metal Roofing/Siding Panel Screw

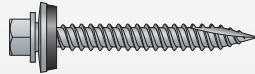

Class 55 galvanized coating, Type-17 point, p. 261

WSCD Roofing Tile Screw



Miami-Dade compliant, meets ASTM B695 Class 55 mechanically galvanized coating, p. 264

WSCT Roofing Tile Screw



Meets ASTM A641 Class 1 standard, heavy-zinc electroplate coating, p. 264

SSWSCB Roofing Tile Screw



Type-17 point, Type 305 stainless steel, p. 264

Wood Framing



Screws

Strong-Drive®
SDWS **FRAMING** Screw



Flat head with box nibs, Quik Guard® coating, p. 68

Strong-Drive®
SDWS **TIMBER** Screw



Washer head, double-barrier coating, p. 69

Strong-Drive®
SDWH **TIMBER-HEX** Screw

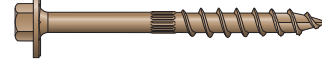

Hex-washer head, double-barrier coating, p. 70

Strong-Drive®
SDWH **TIMBER-HEX HDG** Screw



Hex-washer head, Class C, hot-dip galvanized, p. 72

Strong-Drive®
SDWH **TIMBER-HEX SS** Screw

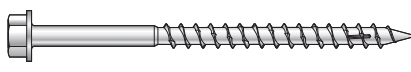

Type 316 stainless steel, p. 71

Strong-Drive®
SDW **TRUSS-PLY** Screw



Washer head, E-Coat™ coating, p. 94

Strong-Drive®
SDW **EWP-PLY** Screw



Washer head, E-Coat™ coating, p. 93

Strong-Drive®
SDWC **TRUSS** Screw



Clear zinc coating (with orange topcoat), p. 92

Strong-Drive®
SDWS **LOG** Screw



Washer head, E-Coat™ coating, p. 94

Strong-Drive®
SDWF **FLOOR-TO-FLOOR** Screw



E-Coat™ coating, p. 95

Strong-Drive®
SDS **HEAVY-DUTY CONNECTOR** Screw



Type 316 stainless steel and double-barrier coating, p. 75

Strong-Drive®
SD **CONNECTOR** Screw



Class 55 mechanically galvanized, p. 76

Wood Framing

Nails

Strong-Drive® SCN
SMOOTH-SHANK CONNECTOR Nail



Bright, hot-dip galvanization, p. 139

Strong-Drive® SCNR
RING-SHANK CONNECTOR Nail



Type 316 stainless steel, hot-dip galvanized, bright, p. 138

Common Nail, Ring-Shank



Types 316 and 304 stainless steel, p. 118

Common Nail, Smooth-Shank

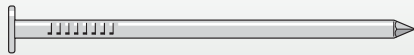

Types 316 and 304 stainless steel, hot-dip galvanized, p. 119

Post and Beam Nail, Ring-Shank



Types 316 and 304 stainless steel, p. 123

Box Nail, Ring-Shank



Types 316 and 304 stainless steel, p. 115

Collated Nails

20°-22° Plastic Strip
Full Round Head, Ring-Shank Nail



Types 316 and 304 stainless steel, p. 170

20°-22° Plastic Strip
Full Round Head, Screw-Shank Nail

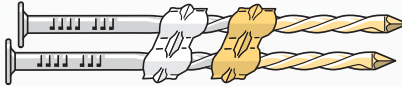

Types 316 and 304 stainless steel, p. 171

20°-22° Plastic Strip
Casing Head, Ring-Shank Nail



Type 304 stainless steel, p. 169

20°-22° Plastic Strip
Full Round Head, Smooth-Shank Nail

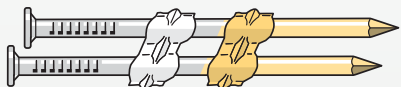

Types 316 and 304 stainless steel, p. 172

28° Wire Weld
Clipped Head, Ring-Shank Nail



Type 304 stainless steel, p. 174

31°-34° Plastic Strip
Full Round Head, Ring-Shank Nail

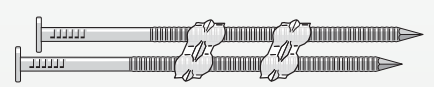

Types 316 and 304 stainless steel, p. 173

31°-34° Paper Tape
Clipped Head, Ring-Shank Nail

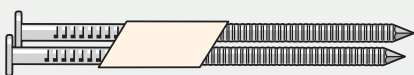

Types 316 and 304 stainless steel, p. 175

15° Wire Coil, Full Round
Head, Ring-Shank Nail



Types 316 and 304 stainless steel, p. 167

Fasteners for Simpson Strong-Tie® Connectors



Screws and Nails

Strong-Drive®
SD **CONNECTOR** Screw

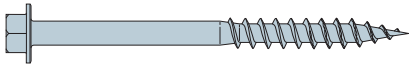

Class 55 mechanically galvanized, p. 76

Strong-Drive®
SDS **HEAVY-DUTY CONNECTOR** Screw

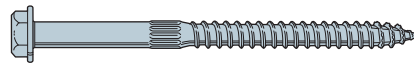

Double-barrier coating, Type 316 stainless steel, p. 75

Wafer-Head Screw

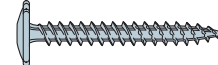

Clear zinc coating, p. 96

Strong-Drive® XE **EXTERIOR STRUCTURAL METAL** Screw



5/16" hex head, Quik Guard® coating, p. 98

Strong-Drive® SCNR **RING-SHANK CONNECTOR** Nail



Type 316 stainless steel, hot-dip galvanized, bright, p. 138

Strong-Drive®
SCN **SMOOTH-SHANK CONNECTOR** Nail

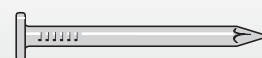

Hot-dip galvanized, bright, p. 139

Collated Nails

Strong-Drive®
33° SCNR **RING-SHANK CONNECTOR** Nail

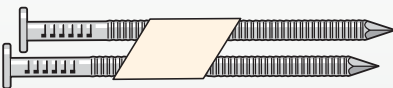

Type 316 stainless steel, Class D, hot-dip galvanized, p. 159

Strong-Drive®
33° SCN **SMOOTH-SHANK CONNECTOR** Nail

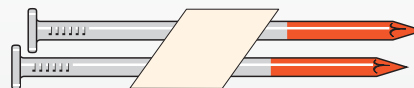

Class D, hot-dip galvanized, bright, electrogalvanized, p. 158

Finishing, Millwork and Trim



Screws and Nails

Deck-Drive™ DWP **WOOD SS** Screw



Trim-head, Types 305 and 316 stainless steel, pp. 79–81

Trim-Head Screw

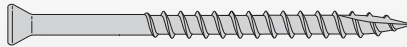

Types 316 and 305 stainless steel, pp. 86, 88; painted head, Types 316 and 305 stainless steel, p. 87

Finishing Nail

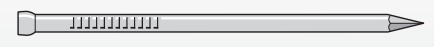

Types 316 and 304 stainless steel, p. 121

PVC Trim-Board Screw

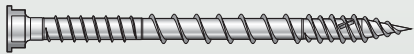

White exterior-grade coating, p. 144

Pocket Hole Screw

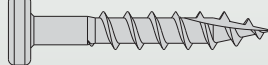

Type 305 stainless steel, p. 152

PVC Trim-Board Nail



Type 316 stainless steel, p. 139

Collated Nails

20° Adhesive Collation
T-Style Head Angle Finishing Nail

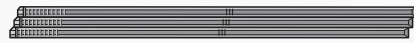

16 gauge, Types 316 and 304 stainless steel, p. 176

33° Tape Collation
DA-Style Head Angle Finishing Nail



15 gauge, Types 316 and 304 stainless steel, p. 180

25° Adhesive Collation
FN-Style Head Angle Finishing Nail



15 gauge, Types 316 and 304 stainless steel, p. 176

16-Gauge Straight Adhesive
Collation T-Style Head Finishing Nail



Types 316 and 304 stainless steel, p. 177

18-Gauge Straight Adhesive
Collation T-Style Head Brads



Types 316 and 304 stainless steel, p. 178

Adhesive Collation Straight
Headless Micro Pins



23 gauge, Type 304 stainless steel, p. 179

15° Inserted Plastic Coil, White
Full Round Head, Ring-Shank Nail



Types 316 and 304 stainless steel, p. 162

Collated Staples

¼" Crown, 18-Gauge Staple



Types 316 and 304 stainless steel, p. 184

Fastening to Metal



Screws

Strong-Drive®
XL **LARGE-HEAD METAL** Screw

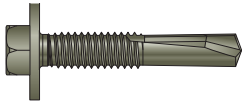

5/16" hex head, Quik Guard® coating, p. 97

Strong-Drive®
XM **MEDIUM-HEAD METAL** Screw



5/16" hex head, Quik Guard® coating, p. 97

Strong-Drive® XE **EXTERIOR STRUCTURAL METAL** Screw



5/16" hex head, Quik Guard® coating, p. 98

Strong-Drive®
FPHSD **FRAMING-TO-CFS** Screw

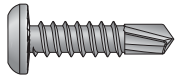

Flat-pan head, clear zinc coating, p. 102

Strong-Drive®
PPSD **SHEATHING-TO-CFS** Screw

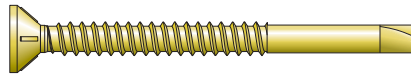

Subfloor to CFS screw Quik Guard® and yellow zinc coating, p. 101

Strong-Drive®
SELF-DRILLING X METAL Screw

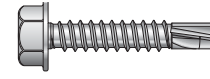

5/16" hex head, Quik Guard® and clear zinc coating, p. 98

PCSD Standing-Seam
Roofing Panel Clip Screw

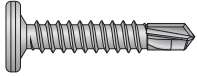

Type 410 stainless steel, Quik Guard® and clear zinc coating, p. 104

Self-Drilling
Fiber-Cement Screw

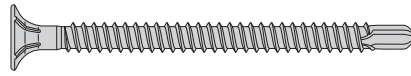

Type 410 stainless steel, p. 106

Self-Drilling Siding Screw

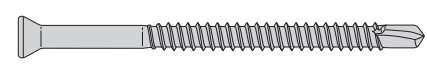

Type 410 stainless steel, p. 108

Self-Drilling Wire-Lath Modified
Truss-Head Screw

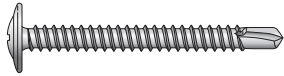

Type 410 stainless steel, p. 110

Self-Drilling Flat-Head Screw with Wings

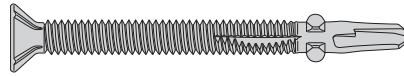

Type 410 stainless steel, p. 107

Strong-Drive®
TB **WOOD-TO-STEEL** Screw



#4 drill point, black phosphate, mechanically galvanized coating, p. 100

Self-Drilling Wafer-Head Screw with Wings

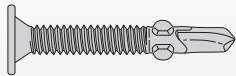

Type 410 stainless steel, p. 109

Pancake-Head Screw



Type 410 stainless steel, Quik Guard® and clear zinc coating, p. 149

Fastening to Metal

Collated Screws for the *QuikDrive*® System

Strong-Drive®
XL **LARGE-HEAD METAL** Screw

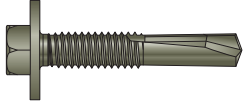

Quik Guard® coating, p. 277

Strong-Drive®
XM **MEDIUM-HEAD METAL** Screw



Quik Guard® coating, p. 277

Strong-Drive®
SELF-DRILLING X METAL Screw

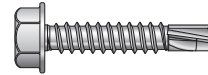

5/16" hex head, Quik Guard® and clear zinc coating, p. 278

Strong-Drive®
TB **WOOD-TO-STEEL** Screw



#4 drill point, black phosphate, yellow zinc, mechanically galvanized coating, p. 274

Strong-Drive®
PPSD **SHEATHING-TO-CFS** Screw

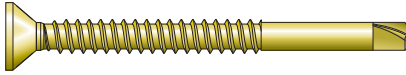

#3 drill point, Quik Guard®, yellow zinc coating, p. 276

FHSD Wood-to-CFS Screw

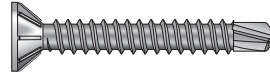

#2 drill point, Type 410 stainless steel, p. 283

DWFSD Drywall-to-CFS Screw



Drywall to steel, #2 point, yellow zinc coating (54, 43 mil / 16, 18 ga.), p. 282

CBSDQ Sheathing-to-CFS Screw



Sheathing to steel, #2 drill point, Quik Guard® coating, p. 281

DWF Drywall-to-CFS Screw



Drywall to steel, gray phosphate coating (33, 27, 18 mil / 20, 22, 25 ga.), p. 282

Fencing



Screws and Nails

Strong-Drive®
SDWS **FRAMING** Screw



Flat head with box nibs, Quik Guard® coating, p. 68

Strong-Drive®
SDWS **TIMBER** Screw



Washer head, double-barrier coating, p. 69

Strong-Drive®
SDWH **TIMBER-HEX** Screw

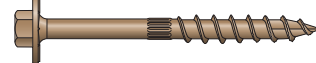

Hex-washer head, double-barrier coating, p. 70

Strong-Drive®
SDWH **TIMBER-HEX SS** Screw

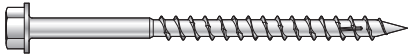

Hex head, Type 316 stainless steel, p. 71

Strong-Drive®
SDS **HEAVY-DUTY CONNECTOR** Screw

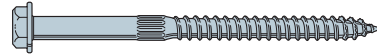

Hex head, double-barrier coating, Type 316 stainless steel, p. 75

Deck-Drive™
DSV **WOOD** Screw



Rimmed flat head with nibs, Quik Guard® coating, p. 78

Deck-Drive™ DWP **WOOD SS** Screw



Flat and trim heads, Types 316 and 305 stainless steel, pp. 79–81; painted head, Types 316 and 305 stainless steel, p. 81

Trim-Head Screw

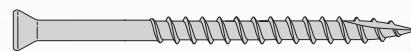

Trim head, Types 316 and 305 stainless steel, pp. 86, 88; painted head, Types 316 and 305 stainless steel, p. 87

Bugle-Head Wood Screw

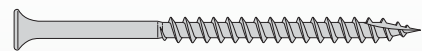

Bugle head, Types 316 and 305 stainless steel, pp. 83–85

Fencing

Collated Nails

20°–22° Plastic Strip, Full Round Head, Ring-Shank Nail



Types 316 and 304 stainless steel, p. 170

28° Wire Weld, Clipped Head, Ring-Shank Nail



Type 304 stainless steel, p. 174

31°–34° Paper Tape, Clipped Head, Ring-Shank Nail



Types 316 and 304 stainless steel, p. 175

15° Wire Coil, Full Round Head, Ring-Shank Nail

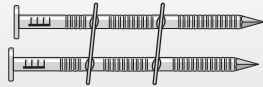

Types 316 and 304 stainless steel, p. 163

0° and 15° Inserted Plastic Coil, Full Round Checkered Head, Ring-Shank Nail



Types 316 and 304 stainless steel, pp. 160–161

Collated Screws for the *Quik Drive*® System

Deck-Drive™
DSV **WOOD** Screw



Flat head, Quik Guard® coating, p. 256

Deck-Drive™
DWP **WOOD SS** Screw

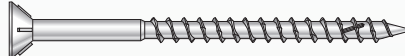

Flat head, Types 316 and 305 stainless steel, p. 257

WSC Wood Screw



Flat head, N2000® coating, p. 263

Cooling Towers



Nails

Common Nail – Annular Ring-Shank



Types 316 and 304 stainless steel, p. 118

Common Nail Spiral-Shank
(Special-Order Option)



Types 316 and 304 stainless steel, p. 118

Box Nail – Annular Ring-Shank



Types 316 and 304 stainless steel, p. 115

Box Nail, Spiral-Shank Nail
(Special-Order Option)



Types 316 and 304 stainless steel,
special order option, p. 115

Roofing Tile and Slating Nail



Types 304 and 316 stainless steel,
copper and aluminum, p. 133

Nail with EPDM Washer –
Annular Ring-Shank



Type 304 stainless steel, p. 122

Screws

Deck-Drive™
DWP **WOOD SS** Screw

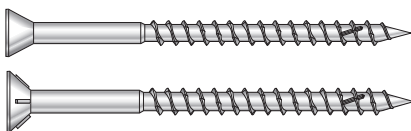

Flat with nibs and trim heads, Types 316 and
305 stainless steel, pp. 79–80; painted head,
Types 316 and 305 stainless steel, p. 81

Bugle-Head Wood Screw

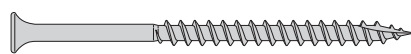

Types 316 and 305 stainless steel,
pp. 83–84

Trim-Head Screw
with EPDM Sealing Washer

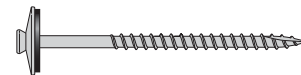

Type 305 stainless steel, p. 150

Self-Drilling
Hex-Washer Head Screw

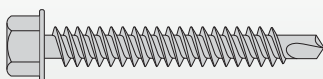

Types 316 and 305 stainless steel, p. 147

Self-Drilling Hex-Washer
Head Screw with EPDM Sealing Washer



Types 316 and 305 stainless steel, p. 148

Cooling Towers

Specialty

Fencing Staples

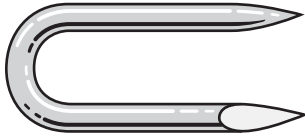

Type 304 stainless steel, p. 141

Hog Ring — #3 Pre-Bent, Hill Pattern



Type 304 stainless steel, p. 141

Sealing Washer



Types 316 and 304 stainless steel, p. 153

Log Homes



Screws

Strong-Drive® SDWS **LOG** Screw



E-coat, p. 94

Steel Decking



Screws

Strong-Drive®
XL LARGE-HEAD METAL Screw

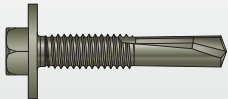

5/16" hex head, Quik Guard® coating, p. 97

Strong-Drive®
XM MEDIUM-HEAD METAL Screw

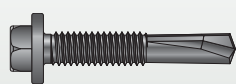

5/16" hex head, Quik Guard® coating, p. 97

Strong-Drive®
SELF-DRILLING X METAL Screw

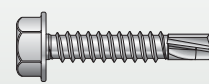

5/16" hex head, Quik Guard® and clear zinc coating, p. 98

Collated Screws for the *QuikDrive*® Systems

Strong-Drive®
XL LARGE-HEAD METAL Screw

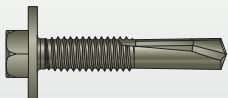

Quik Guard® coating, p. 277

Strong-Drive®
XM MEDIUM-HEAD METAL Screw



Quik Guard® coating, p. 277

Strong-Drive®
SELF-DRILLING X METAL Screw

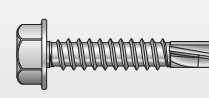

5/16" hex head, Quik Guard® and clear zinc coating, p. 278

Truss-Ply Fastening Applications



Screws

Strong-Drive®
SDW **TRUSS-PLY** Screw



Multi-ply fastening
washer head E-Coat™ coating, p. 94

Collated for the *QuikDrive*® System

Strong-Drive®
WSNTL **WOOD** Screw



Twin thread, yellow zinc coating, p. 267

Drywall and Exterior Gypsum Sheathing Applications



Collated Screws for the *QuikDrive*® System

DWC Drywall Screw



Drywall to wood, gray phosphate,
N2000® coating, p. 270

DWF Drywall-to-CFS Screw



Drywall to steel, gray phosphate coating
(33, 27, 18 mil / 20, 22, 25 ga.), p. 282

DWHL Drywall Screw



High-low threads, gray phosphate coating,
p. 271

DWFSD Drywall-to-CFS Screw



Drywall to CFS, Quik Guard®
and yellow zinc coating, p. 282

Crating



Screws

Strong-Drive®
SDWS **FRAMING** Screw



Flat head with box nibs, Quik Guard® coating, p. 68

Strong-Drive®
SDWS **TIMBER** Screw



Washer head, double-barrier coating, p. 69

Wafer-Head Screw



Clear zinc coating, p. 96

Deck-Drive™
DSV **WOOD** Screw

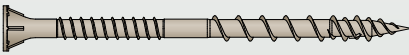

Rimmed flat head with nibs, Quik Guard® coating, p. 78

Strong-Drive®
WSNTL **SUBFLOOR** Screw



Wood-to-wood applications, yellow zinc coating, twin thread, p. 96

Collated Screws for the QuikDrive® System

DWC Drywall Screw



Drywall to wood, gray phosphate, N2000® coating, p. 270

Strong-Drive®
WSV **SUBFLOOR** Screw

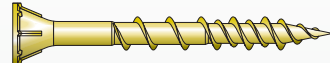

Wood-to-wood applications, yellow zinc coating, p. 267

Strong-Drive®
WSNTL **WOOD** Screw



Twin thread, yellow zinc coating, p. 267

PHSS Wood Screw



Yellow zinc coating, p. 273

WSHL Subfloor Screw



Wood-to-wood applications, gray phosphate coating, high-low threads, p. 270

Deck-Drive™
DSV **WOOD** Screw



Rimmed flat head with nibs, Quik Guard® coating, p. 256

Boat Building / Marine Trade



Screws and Nails

Marine Screw – Flat Head

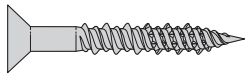

Type 316 stainless steel, p. 143

Marine Screw – Pan Head

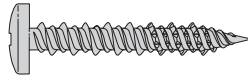

Type 316 stainless steel, p. 142

Roofing – Annular Ring-Shank



Silicon bronze available for special order, p. 130

Finishing Nail

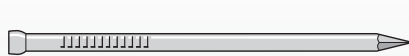

Type 316 stainless steel, p. 121

Premium Common Nail



Type 316 stainless steel, passivated, p. 114

Common Nail – Annular Ring-Shank



Types 316 and 304 stainless steel, silicon bronze, p. 118

Common Nail – Smooth Shank

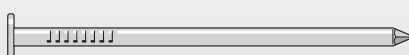

Types 316 and 304 stainless steel, silicon bronze, p. 119

Collated Nails

20°–22° Plastic Strip, Full Round Head, Smooth-Shank Nail



Types 316 and 304 stainless steel, p. 172

15° Wire Coil, Full Round Head, Roofing Nail



Types 316 and 304 stainless steel, p. 165

15° Wire Coil, Full Round Head, Ring-Shank Nail



Types 316 and 304 stainless steel, p. 167



Deck-Drive™ DSV WOOD Screw

**Designed for the
rigors of wood deck
fastening.**



Screws

Exterior Wood Screws

Strong-Drive® SDWS FRAMING Screw	68
Strong-Drive® SDWS TIMBER Screw	69
Strong-Drive® SDWH TIMBER-HEX Screw	70
Strong-Drive® SDWH TIMBER-HEX SS Screw	71
Strong-Drive® SDWH TIMBER-HEX HDG Screw	72
Outdoor Accents® Structural Wood Screw	73
Outdoor Accents® Hex-Head Washer	73
Outdoor Accents® Connector Screw	74
Strong-Drive® SDS HEAVY-DUTY CONNECTOR Screw	75
Strong-Drive® SD CONNECTOR Screw	76
Screw Substitution Calculator	77
Deck-Drive™ DSV WOOD Screw	78
Deck-Drive™ DWP WOOD SS Screw — Flat Head	79
Deck-Drive™ DWP WOOD SS Screw — Trim Head	81
Deck-Drive™ DHPD HARDWOOD Screw	82
Bugle-Head Wood Screw — 6-Lobe Drive	83
Bugle-Head Wood Screw — Square Drive	84
Trim-Head Screw — Square Drive	86
Trim-Head Screw — 6-Lobe Drive	87

Composite Decking Screws

Deck-Drive™ DCU COMPOSITE Screw	89
Dexxter™ Composite-Decking Screw	91

Interior Wood Screws

Strong-Drive® SDWC TRUSS Screw	92
Strong-Drive® SDW EWP-PLY Screw	93
Strong-Drive® SDW TRUSS-PLY Screw	94
Strong-Drive® SDWS LOG Screw	94
Strong-Drive® SDWF FLOOR-TO-FLOOR Screw	95
Strong-Drive® SDWV SOLE-TO-RIM Screw	95
Strong-Drive® WSNTL SUBFLOOR Screw	96
Wafer-Head Screw	96
MTH Underlayment Screw	96

Metal Screws

Strong-Drive® XL LARGE-HEAD METAL Screw	97
Strong-Drive® XM MEDIUM-HEAD METAL Screw	97
Strong-Drive® XE EXTERIOR STRUCTURAL METAL Screw	98
Strong-Drive® SELF-DRILLING X METAL Screw	98
Self-Drilling E Metal Screw	99
Strong-Drive® TB WOOD-TO-STEEL Screw	100
Strong-Drive® PPSD SHEATHING-TO-CFS Screw	101
Strong-Drive® FPHSD FRAMING-TO-CFS Screw	102
Steel Deck Diaphragm Calculator	103
PCSD Standing-Seam-Roofing Panel Clip Screw	104
Self-Drilling Pancake-Head Screw	104
Self-Drilling Bugle-Head Screw	105
Self-Drilling Fiber-Cement Screw	106
Self-Drilling Flat-Head Screw with Wings	107
Self-Drilling Siding Screw	108
Self-Drilling Wafer-Head Screw with Wings	109
Self-Drilling Wire-Lath Modified Truss-Head Screw	110

Parts and Accessories

Driver Bits	111
-------------	-----

Exterior Wood Screws

Strong-Drive® SDWS FRAMING Screw

Multipurpose Wood-to-Wood Including Framing, Indoor/Outdoor Projects

The SDWS Framing screw is designed and load-rated for replacing 16d, 10d and 8d nails in framing applications. The SDWS Framing screw is 0.160" in diameter and superior to nails in holding power and pull-out resistance. It is code listed under IAPMO-UES ER-192 and meets 2012 and 2015 IRC® and IBC® code requirements for several common wood framing applications.

The screw has a SawTooth™ Type-17 point with serrated threads that makes for fast installations with reduced torque without predrilling, and its specially-designed head countersinks easily to provide a clean, flush finish. The T-25 bit holds the 6-lobe recess tightly, reducing cam-out and head stripping.

Features:

- Large head with underhead box-nibs provides increased bearing in structural applications and provides clean and easy countersinking (0.44" head dia.)
- The 6-lobe drive reduces driver-bit cam-outs, resulting in easier installations and longer bit life
- SawTooth™ Type-17 point for quick starts with no pre-drilling
- Quik Guard® coating provides protection in indoor and outdoor applications
- Serrated threads reduce installation torque for easier driving

Codes/Standards: IAPMO-UES ER-192, State of Florida FL13975

For Technical Data and Loads, see pp. 288–291

U.S. Patent Pending

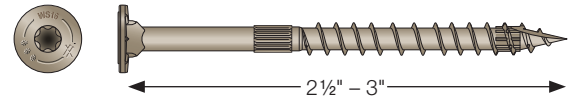

Quik Guard® Coating

Nominal Screw Length (in.)	Shank Diameter (in.)	Thread Length (in.)	Retail Pack			Mini-Bulk			Bulk		
			Fasteners per Pack	Packs per Master Carton	Model No.	Fasteners per Pack	Packs per Master Carton	Model No.	Fasteners per Pack	Packs per Master Carton	Model No.
2½	0.160	1.125	75	12	SDWS16212QR75	250	4	SDWS16212QMB	1,000	1	SDWS16212Q
3	0.160	1.625	75	12	SDWS16300QR75	250	4	SDWS16300QMB	1,000	1	SDWS16300Q

Replacement driver bit: BIT25T-2.

Exterior Wood Screws

Strong-Drive® SDWS TIMBER Screw

Structural Wood-to-Wood Connections Including Ledgers

Designed to provide an easy-to-install, high-strength alternative to through-bolting and traditional lag screws. Strong-Drive® SDWS Timber screws are ideal for the contractor and do-it-yourselfer alike. It is code listed under IAPMO-UES ER-192 and meets 2012 and 2015 IRC® and IBC® code requirements for several common wood framing applications.

Features:

- Bold thread design provides superior holding power
- Patented 4CUT™ tip ensures fast starts, reduces installation torque and eliminates the need for pre-drilling in most applications
- Under-head nibs offer greater control when seating the head
- Large washer head provides maximum bearing area (0.75" head dia.)
- Size identification on all SDWS screw heads
- 6-lobe T-40 drive reduces driver-bit cam-outs, resulting in easier installations and longer bit life

Double-barrier coating provides corrosion resistance equivalent to hot-dip galvanization, making it suitable for certain exterior and preservative-treated wood applications, as described in the evaluation report.

Codes/Standards: IAPMO-UES ER-192, State of Florida FL13975, City of Los Angeles RR25906

For Technical Data and Loads, see pp. 292–305

U.S. Patents 5,897,280; 7,101,133

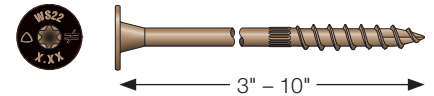

Double-Barrier Coating

Size Dia. x L (in.)	Thread Length (in.)	Retail Clam			Retail Pack			Mini-Bulk		Bulk	
		Fasteners Per Pack	Packs Per Master Carton	Model No.	Fasteners Per Pack	Packs Per Master Carton	Model No.	Fasteners Per Pack	Model No.	Fasteners Per Pack	Model No.
0.220 x 3	1½	12	10	SDWS22300DB-RC12	50	6	SDWS22300DB-R50	250	SDWS22300DBMB	950	SDWS22300DB
0.220 x 4	2¾	12	10	SDWS22400DB-RC12	50	6	SDWS22400DB-R50	250	SDWS22400DBMB	600	SDWS22400DB
0.220 x 5	2¾	12	10	SDWS22500DB-RC12	50	6	SDWS22500DB-R50	250	SDWS22500DBMB	600	SDWS22500DB
0.220 x 6	2¾	12	10	SDWS22600DB-RC12	50	6	SDWS22600DB-R50	250	SDWS22600DBMB	500	SDWS22600DB
0.220 x 8	2¾	12	10	SDWS22800DB-RC12	50	6	SDWS22800DB-R50	250	SDWS22800DBMB	400	SDWS22800DB
0.220 x 10	2¾	12	10	SDWS221000DBRC12	50	6	SDWS221000DB-R50	—	—	250	SDWS221000DB

Retail and mini-bulk packs include one 6-lobe, T-40 driver bit; bulk packs include two driver bits.

Exterior Wood Screws

Strong-Drive® SDWH TIMBER-HEX Screw

Structural Wood-to-Wood Connections Including Ledgers

Ideal for structural and general-purpose fastening applications where a hex-head drive is preferred. Strong-Drive® SDWH Timber-Hex screws are ideal for the contractor and do-it-yourselfer alike. It is code listed under IAPMO-UES ER-192 and meets 2012 and 2015 IRC® and IBC® code requirements for several common wood framing applications.

Features:

- Bold thread design provides superior holding power
- Patented 4CUT™ tip ensures fast starts, reduces installation torque and eliminates the need for pre-drilling in most applications
- Under-head nibs offer greater control when seating the head
- Large washer head provides maximum bearing area (0.64" washer head dia.)
- Size identification on all SDWH screw heads
- 5/16" hex drive (replacement driver bit – BITHEXR516-134)

Double-barrier coating provides corrosion resistance equivalent to hot-dip galvanization, making it suitable for certain exterior and preservative-treated wood applications, as described in the evaluation report.

Codes/Standards: IAPMO-UES ER-192, State of Florida FL13975

For Technical Data and Loads, see pp. 311–320

U.S. Patents 5,897,280; 7,101,133

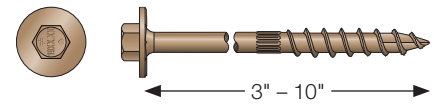

Double-Barrier Coating

Size Dia. x L (in.)	Thread Length (in.)	Retail Clam			Retail Pack			Mini-Bulk		Bulk	
		Fasteners Per Pack	Packs Per Master Carton	Model No.	Fasteners Per Pack	Packs Per Master Carton	Model No.	Fasteners Per Pack	Model No.	Fasteners Per Pack	Model No.
0.195 x 3	1½	12	10	SDWH19300DB-RC12	50	6	SDWH19300DB-R50	250	SDWH19300DBMB	1,000	SDWH19300DB
0.195 x 4	2¾	12	10	SDWH19400DB-RC12	50	6	SDWH19400DB-R50	250	SDWH19400DBMB	800	SDWH19400DB
0.195 x 6	2¾	12	10	SDWH19600DB-RC12	50	6	SDWH19600DB-R50	250	SDWH19600DBMB	600	SDWH19600DB
0.195 x 8	2¾	12	10	SDWH19800DB-RC12	50	6	SDWH19800DB-R50	250	SDWH19800DBMB	500	SDWH19800DB
0.195 x 10	2¾	12	10	SDWH191000DBRC12	50	6	SDWH191000DB-R50	—	—	250	SDWH191000DB

Retail and mini-bulk packs include one 5/16" hex driver bit; bulk packs include two driver bits.

Exterior Wood Screws

Strong-Drive® SDWH TIMBER-HEX SS Screw

Structural Wood-to-Wood Connections Including Ledgers

Stainless-steel structural fasteners designed for lag-screw replacement. These 0.188" and 0.276" diameter hex-head fasteners require no pre-drilling, making them easier and faster to install than typical lag screws. It meets 2012 and 2015 IRC® and IBC® code requirements for several common wood framing applications.

Features:

- Type 316 stainless steel for maximum corrosion protection
- No predrilling necessary in most applications
- Driver bit included (replacement driver bit – BITHEXR516-134 or BITHEXR12-134)
- Can be used in ledger applications
- Unique “box” thread design with raised-ridge technology significantly reduces driving torque and installation time
- Hex-washer head provides large bearing area

For Technical Data and Loads, see pp. 324–326

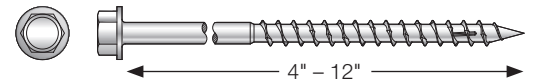

Type 316 Stainless Steel

Size (in.)	Hex Drive (in.)	Hex Washer Dia. (in.)	Thread Length (in.)	Individually Flagged Retail Box		Package		Bucket	
				Fasteners Per Pack	Model No.	Fasteners Per Pack	Model No.	Fasteners Per Bucket	Model No.
0.188 x 4	5/16	0.45	2.40	—	—	20	SDWH19400SS-R20	100	SDWH19400SS-R100
0.188 x 4½	5/16	0.45	2.75	—	—	10	SDWH19450SS-R10	100	SDWH19450SS-R100
0.188 x 5	5/16	0.45	2.40	—	—	10	SDWH19500SS-R10	100	SDWH19500SS-R100
0.188 x 6	5/16	0.45	2.40	—	—	10	SDWH19600SS-R10	100	SDWH19600SS-R100
0.188 x 8	5/16	0.45	2.40	—	—	10	SDWH19800SS-R10	50	SDWH19800SS-R50
0.276 x 3	½	0.66	2.95	50	SDWH27300SS-RP1	10	SDWH27300SS-R10	100	SDWH27300SS-R100
0.276 x 4	½	0.66	2.95	50	SDWH27400SS-RP1	10	SDWH27400SS-R10	100	SDWH27400SS-R100
0.276 x 5	½	0.66	2.95	40	SDWH27500SS-RP1	10	SDWH27500SS-R10	50	SDWH27500SS-R50
0.276 x 6	½	0.66	2.95	35	SDWH27600SS-RP1	10	SDWH27600SS-R10	50	SDWH27600SS-R50
0.276 x 8	½	0.66	2.95	25	SDWH27800SS-RP1	10	SDWH27800SS-R10	25	SDWH27800SS-R25
0.276 x 10	½	0.66	2.95	25	SDWH271000SS-RP1	5	SDWH271000SS-R5	25	SDWH271000SS-R25
0.276 x 12	½	0.66	2.95	—	—	5	SDWH271200SS-R5	25	SDWH271200SS-R25

Exterior Wood Screws

Strong-Drive® SDWH TIMBER-HEX HDG Screw

Structural Wood-to-Wood Including Ledgers

The SDWH Timber-Hex HDG screw is a 0.276 diameter hot-dip galvanized screw suitable for marine and coastal applications. The SDWH Timber-Hex HDG screw has a SawTooth™ point and oversized integral washer that makes for fast installations; no predrilling or separate washer needed. Speed up your next pile job by replacing ¾" and 1" HDG bolt/washer/nut assemblies (two screws for one bolt in many conditions) with the new Strong-Drive SDWH Timber-Hex HDG screw. It is code listed under IAPMO-UES ER-192 and meets 2012 and 2015 IRC® and IBC® code requirements for several common wood framing applications.

Features:

- Burly 0.28" shank diameter for heavy-duty structural applications
- ASTM A153 Class-C hot-dip galvanized coating suitable for coastal and marine environments
- SawTooth™ point design for fast starts and no predrilling
- Oversized 0.93" diameter integral washer eliminates the need for a separate washer
- ¾" hex drive for secure driving (replacement driver bit – BITHEXR38-134)

Codes/Standards: IAPMO-UES ER-192*, City of Los Angeles RR25906, State of Florida FL13975

For Technical Data and Loads, see pp. 321–323

Install Tips: For best results, use a minimum of ½" low-speed corded drill to install

U.S. Patent Pending

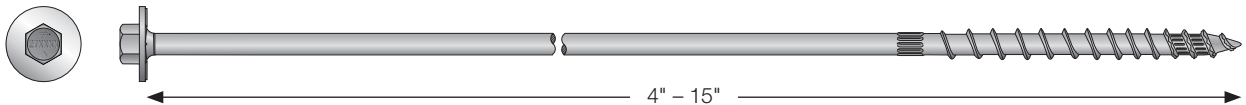

Class C, Hot Dip Galvanized

Screw Length (in.)	Screw Dia. (in.)	Hex-Drive (in.)	Thread Length (in.)	Individually Flagged Retail Box		Retail		Mini-Bulk		Bucket	
				Fasteners Per Pack	Model No.	Fasteners Per Pack	Model No.	Fasteners Per Pack	Model No.	Fasteners Per Pack	Model No.
4	0.276	¾"	3	40	SDWH27400G-RP1	30	SDWH27400GR30	150	SDWH27400GMB	350	SDWH27400G
6	0.276	¾"	3	35	SDWH27600G-RP1	30	SDWH27600GR30	150	SDWH27600GMB	300	SDWH27600G
8	0.276	¾"	3	25	SDWH27800G-RP1	30	SDWH27800GR30	150	SDWH27800GMB	—	—
10	0.276	¾"	3	25	SDWH271000G-RP1	30	SDWH271000GR30	150	SDWH271000GMB	—	—
12	0.276	¾"	3	25	SDWH271200G-RP1	30	SDWH271200GR30	150	SDWH271200GMB	—	—
15	0.276	¾"	3	—	—	—	—	100	SDWH271500GMB	—	—

*15" SDWH Timber-Hex HDG screw is not listed in IAPMO-UES ER-192.

Exterior Wood Screws

Outdoor Accents® Decorative Hardware

The new Outdoor Accents® decorative hardware features connectors and fasteners for building custom outdoor living structures that are stylish and structurally strong. The line includes post bases, angles, T and L ties and fasteners.



Outdoor Accents® Structural Wood Screw

The Outdoor Accents® structural wood screw reduces installation time by driving easily without predrilling. When combined with the patent-pending, load-rated Outdoor Accents hex-head washer, the solution delivers the decorative appearance of a bolted connection but with a much easier installation. The screw's bold thread design enables superior holding to attach ledgers and other secure connections.

Features:

- Use with Outdoor Accents® decorative hardware and hex-head washer (sold separately) for an appealing look
- Use Outdoor Accents® structural wood screw primarily as a wood-to-wood fastener
- Underhead nibs offer greater control when seating the head
- Patented 4CUT™ tip ensures fast starts, reduces installation torque and eliminates the need for predrilling in most applications
- Black double-barrier coating provides premium look while providing a medium level of corrosion protection for many outdoor applications

Codes/Standards: IAPMO-UES ER-192, State of Florida FL13975

For Technical Data and Loads, see p. 306

Install Tips: For best results, use a minimum of ½" low-speed corded drill to install



Black Double-Barrier Coating

Size Dia. x L (in.)	Thread Length (in.)	Retail Pack Quantity	Master Carton Quantity	Model No.
0.220 x 3 ½	2	12	10	SDWS22312DBBRC12
0.220 x 3 ½	2	50	6	SDWS22312DBB-R50
0.220 x 5 ½	2 ¾	12	10	SDWS22512DBBRC12

Outdoor Accents® Hex-Head Washer

The Outdoor Accents® hex-head washer provides the decorative appearance of a bolted connection. Its patent-pending design provides an easier and significantly faster installation time compared to through-bolting. The hex-head washer is code listed (IAPMO-UES ER-192) and is designed exclusively to help fasten Outdoor Accents post bases, T and L straps, and angles.

Features:

- Combined with the Outdoor Accents structural wood screw, it provides a structural load-rated solution
- Easy to install
- Black Quik Guard® coating for exterior use

Codes/Standards: IAPMO-UES ER-192, State of Florida FL13975 (STN)

For Technical Data and Loads, see p. 306

U.S. Patent Pending

Black Quik Guard® Coating

Hex-Head Dia. (in.)	Hex-Head Washer Dia. (in.)	Retail Pack Quantity	Master Carton Quantity	Model No.
1	1 ½	8	10	STN22-R8



SDWS22312DBB with STN22 Hex-Head Washer



C-F-2017 © 2017 SIMPSON STRONG-TIE COMPANY INC.

Screws

Exterior Wood Screws

Outdoor Accents® Connector Screw

The Outdoor Accents® connector screw reduces installation time by driving easily without predrilling. Designed for installation with the Outdoor Accents APA21 90-degree angle, the screw's black finish accents any outdoor living project. The sharp point of the screw enables fast starts, and the patented serrated threads reduce torque for improved drivability.

Features:

- Use with Outdoor Accents® decorative hardware (sold separately) for an appealing look
- Black double-barrier coating provides premium look while providing a medium level of corrosion protection for many outdoor applications
- ¼" hex head reduces cam-out for easier installation and helps avoid stripping of the head during installation

Codes/Standards: ICC-ES ESR-3046, State of Florida FL9589

For Technical Data and Loads, see p. 307

U.S. Patent Pending

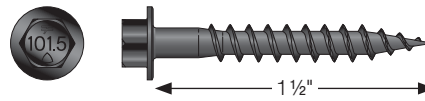

Black Double-Barrier Coating

Size	Length (in.)	Retail Pack Quantity	Master Carton Quantity	Model No.
#10	1½	50	5	SD10112DBBR50



Exterior Wood Screws

Strong-Drive® SDS HEAVY-DUTY CONNECTOR Screw

Heavy-Duty Simpson Strong-Tie® Connectors

A ¼" diameter high-strength structural wood screw ideal for various connector installations as well as wood-to-wood applications.

Features:

- Patented 4CUT™ tip (coated version) and Type-17 point (stainless version) enable easy driving with no pre-drilling and minimal splitting
- Available with a double-barrier coating and Type 316 stainless steel
- ¾" hex head with 0.48" integrated washer
- Head is stamped with the Simpson Strong-Tie "S" sign and fastener length for easy identification after installation
- Replacement driver bit – BITHEXR38-134

Install Tips: A low-speed ½" drill with a ¾" hex driver is the recommended tool for installation.

Codes/Standards: ICC-ES ESR-2236, City of L.A. RR25711, State of Florida FL9589

For Technical Data and Loads, see pp. 329–333

U.S. Patents 5,897,280; 7,101,133

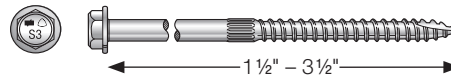

Type 316 Stainless Steel

Size (in.)	Thread Length (in.)	Retail Pack		Bulk	
		Fasteners Per Pack	Model No.	Fasteners Per Pack	Model No.
¼ x 1½	1	25	SDS25112SS-R25	1,500	SDS25112SS
¼ x 2	1¼	25	SDS25200SS-R25	—	—
¼ x 2½	1½	25	SDS25212SS-R25	1,100	SDS25212SS
¼ x 3	2	25	SDS25300SS-R25	950	SDS25300SS
¼ x 3½	2¼	25	SDS25312SS-R25	900	SDS25312SS
		25	SDS25312SS-R25L*	—	—

* Packaged in a ledger-specific box with ¾" hex-driver bit.

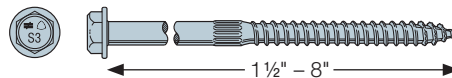

Double-Barrier Coating

Size (in.)	Thread Length (in.)	Retail Pack		Mini Bulk		Bulk	
		Fasteners Per Pack	Model No.	Fasteners Per Pack	Model No.	Fasteners Per Pack	Model No.
¼ x 1½	1	25	SDS25112-R25	300	SDS25112MB	1,500	SDS25112
¼ x 2	1¼	25	SDS25200-R25	250	SDS25200MB	1,300	SDS25200
¼ x 2½	1½	25	SDS25212-R25	200	SDS25212MB	1,100	SDS25212
¼ x 3	2	25	SDS25300-R25	150	SDS25300MB	950	SDS25300
¼ x 3½	2¼	10	SDS25312-R10	125	SDS25312MB	900	SDS25312
		25	SDS25312-R25L*	—	—	—	—
¼ x 4½	2¾	10	SDS25412-R10	100	SDS25412MB	800	SDS25412
¼ x 5	2¾	10	SDS25500-R10	—	—	—	—
		25	SDS25500-R25L*	100	SDS25500MB	500	SDS25500
¼ x 6	3¼	10	SDS25600-R10	100	SDS25600MB	600	SDS25600
¼ x 8	3¼	50	SDS25800-R50	—	—	400	SDS25800
		10	SDS25800-R10	—	—	—	—

* Packaged in a ledger-specific box with ¾" hex-driver bit.

Exterior Wood Screws

Strong-Drive® SD CONNECTOR Screw

Simpson Strong-Tie® Connectors

The Strong-Drive® SD Connector screw is specifically designed to replace nails in certain Simpson Strong-Tie connectors, and is the only screw approved for that application. The load-rated SD screw has been tested and approved for use in many popular Simpson Strong-Tie products. In certain applications screws are easier and more convenient to install than nails, and the single-fastener load values achieved by the SD screw exceed those of typical 10d common or 16d common nails. In addition, the galvanized coating makes the SD screw ideal for both interior and most exterior conditions.

Features:

- Specifically designed to replace nails in certain Simpson Strong-Tie connectors, and is the only screw approved for that application. The #9 and #10 SD screws replace 10d and 16d nails, respectively.
- Tested and approved for use in many of our best-selling connectors for both interior and exterior applications.
- Ideal for use in connector applications where more control is desired or using a hammer is inconvenient.
- 1/4" hex head with 0.37" dia. integrated washer reduces cam-out and is stamped with the Simpson Strong-Tie "S" sign and the fastener size for easy identification after installation.
- Shank is specifically designed to match the fastener holes in Simpson Strong-Tie connectors.
- Patented serrated threads and sharp point make driving easy.
- Optimized heat treating for ductility and strength.
- The single-fastener load capacity of the SD9 exceeds the capacity of a 10d common nail, while the single-fastener load capacity of the SD10 exceeds that of the 16d common nail.
- Hex driver included.

Mechanically-galvanized coating meets ASTM B695 Class 55, is recommended for use with certain preservative-treated woods and recognized as an alternate to hot-dip galvanized in ESR-3046; it is compliant with the 2012 International Residential Code®.

Codes/Standards: ICC-ES ESR-3046, State of Florida FL9589

For Technical Data and Loads, see pp. 334–336

U.S. Patent 7,101,133

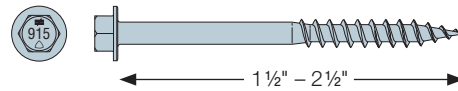

Mechanically-Galvanized Coating – Class 55

Size	Length (in.)	Retail Pack			Contractor Pack			Mini Bulk	
		Fasteners Per Pack	Packs Per Master Carton	Model No.	Fasteners Per Pack	Packs Per Master Carton	Model No.	Fasteners Per Pack	Model No.
#9	1½	100	10	SD9112R100	500	3	SD9112R500	3,000	SD9112MB
#9	2½	100	6	SD9212R100-R	500	2	SD9212R500	2,000	SD9212MB
#10	1½	100	10	SD10112R100	500	3	SD10112R500	3,000	SD10112MB
#10	2½	100	6	SD10212R100-R	500	2	SD10212R500	2,000	SD10212MB

Screw Calculator

Select the Right Fastener for Your Job — Screw Substitution Calculator

The Screw Substitution Calculator is a quick, easy-to-use tool for providing Simpson Strong-Tie® structural screw alternatives to specified standard NDS fasteners in withdrawal, lateral load parallel-to-grain, lateral load perpendicular-to-grain and multi-ply connections. The Calculator provides detailed load calculations for both the NDS fastener and the recommended Simpson Strong-Tie structural screw. See strongtie.com/webapps/screwsubstitutioncalculator for more information.

Select fasteners based on:

- Withdrawal loading
- Lateral loads, parallel or perpendicular to grain
- Multi-ply connections

Screw Substitution Calculator

The Screw Substitution Calculator is a quick, easy-to-use tool for providing Simpson Strong-Tie structural screw alternatives to specified standard NDS fasteners in withdrawal, lateral load parallel-to-grain, lateral load perpendicular-to-grain and multi-ply connections. The Calculator provides detailed load calculations for both the NDS fastener and the recommended Simpson Strong-Tie structural screw.

[Report Application Issues or Provide Customer Feedback](#)
 [Video Tutorial](#)
 [About SSC](#)



WITHDRAWAL
LOADING



LATERAL LOAD
PARALLEL TO GRAIN



LATERAL LOAD
PERPENDICULAR TO GRAIN



MULTI-PLY
CONNECTIONS

General

Select Application

Fastener Substitution

OR

Load Entry

e.g., 250

Design Method

Allowable Stress Design (ASD)

Code

NDS 2005
 NDS 2012

Side Member

Choose Member

Side Member Species

- Select One -

Specific Gravity

e.g., 0.48

Side Member Thickness

e.g., 1.0 in

Main Member

Choose Member

Main Member Species

- Select One -

Specific Gravity

e.g., 0.48

Main Member Thickness

e.g., 1.0 in

Fastener Information

Fastener

Fastener Type

Fastener Diameter/Type

Length

Fastener Options

Rows

Spacing

One Fastener

OR

e.g., 2

e.g., 12 in

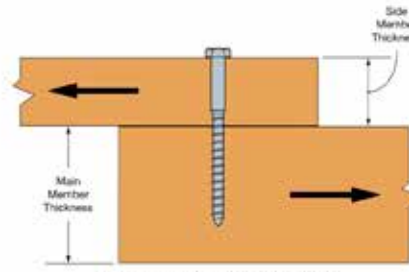

Lateral Load Parallel to Grain

Screw Substitution Calculator — Lateral Load Parallel to Grain Input Screen

Exterior Wood Screws

Deck-Drive™ DSV WOOD Screw

Preservative-Treated Decking and Exterior Wood-to-Wood Applications

The Deck-Drive® DSV Wood screw is a powerful fastening solution for preservative-treated decking applications. With its under-head nibs and fast-start tip, the DSV is ideally suited to be driven and countersunk into today's wood deck boards. The shank is designed to withstand the swelling and shrinkage that is common with fast-growth lumber. Available in hand-drive and in collated strips for use in our Quik Drive® auto-feed screw driving system, DSV screws are also offered in a variety of sizes to fasten fascia and trim.

Features:

- Low-torque threads allow up to 35% more screws to be driven on a battery charge
- Ribbed-head design countersinks easily and provides a clean, finished appearance
- High-low tip provides fast starts
- Optimized threads for dimensional lumber
- Quik Guard coating provides corrosion resistance for exterior and certain preservative-treated wood applications
- Painted to blend with wood decking
- T-25 6-lobe driver bit included (replacement driver bit – BIT25T-2)
- Meets performance requirements of AC257 exposure conditions 1 and 3

This screw is also available collated for the Quik Drive® system. See p. 256 for details.

U.S. Patent 6,074,149

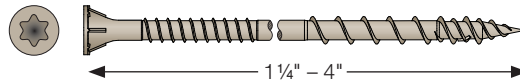

Quik Guard® Coating – Tan

Size	Length (in.)	Head Dia. (in.)	Approx. Count Per Pound	1 lb. Model No.	5 lb. Model No.	350 ct. Model No.	Mini-Bulk	
							Model No.	Count
#8	1¼	0.33	194	DSVT114R1LB	DSVT114R5LB	DSVT114R350	DSVT114MB	1,750
#8	1½	0.33	159	DSVT158R1LB	DSVT158R5LB	DSVT158R350	DSVT158MB	1,750
#10	2	0.33	113	DSVT2R1LB	DSVT2R5LB	DSVT2R350	DSVT2MB	1,750
#10	2½	0.33	91	DSVT212R1LB	DSVT212R5LB	DSVT212R350	DSVT212MB	1,750
#10	3	0.33	76	DSVT3R1LB	DSVT3R5LB	DSVT3R350	DSVT3MB	1,750
#10	3½	0.33	66	DSVT312R1LB	DSVT312R5LB	DSVT312R350	DSVT312MB	1,000
#10	4	0.33	59	DSVT4R1LB	DSVT4R5LB	DSVT4R350	DSVT4MB	1,000

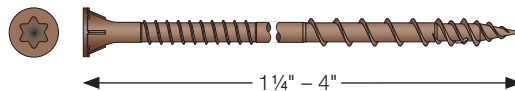

Quik Guard® Coating – Red

Size	Length (in.)	Head Dia. (in.)	Approx. Count Per Pound	1 lb. Model No.	5 lb. Model No.	350 ct. Model No.	Mini-Bulk	
							Model No.	Count
#8	1¼	0.33	194	DSVR114R1LB	DSVR114R5LB	DSVR114R350	DSVR114MB	1,750
#8	1½	0.33	159	DSVR158R1LB	DSVR158R5LB	DSVR158R350	DSVR158MB	1,750
#10	2	0.33	113	DSVR2R1LB	DSVR2R5LB	DSVR2R350	DSVR2MB	1,750
#10	2½	0.33	91	DSVR212R1LB	DSVR212R5LB	DSVR212R350	DSVR212MB	1,750
#10	3	0.33	76	DSVR3R1LB	DSVR3R5LB	DSVR3R350	DSVR3MB	1,750
#10	3½	0.33	66	DSVR312R1LB	DSVR312R5LB	DSVR312R350	DSVR312MB	1,000
#10	4	0.33	59	DSVR4R1LB	DSVR4R5LB	DSVR4R350	DSVR4MB	1,000

Exterior Wood Screws

Deck-Drive™ DWP WOOD SS Screw

Decking, Docks and Boardwalks; Finishing, Millwork and Trim

The Deck-Drive™ DWP Wood SS screw is a powerful fastening solution for deck, dock and general exterior applications where extra corrosion protection is needed. With its specially-designed sharp-point and unique box-threads, the DWP is ideally suited for the majority of wood used in today's deck boards. Choose Type 316 stainless steel for seaside and coastal environments. Available in hand-drive and in collated strips for use in our Quik Drive® auto-feed screw driving system, DWP screws are also offered in a variety of sizes to fasten fascia and trim.

Features:

- Unique "box" thread design with raised-ridge technology greatly reduces driving torque, which allows you to drive more screws on a single battery charge
- Specially-designed sharp point penetrates hard wood products with ease
- 6-lobe drive helps prevent driver-bit cam-out, resulting in easier driving and longer bit life
- Choose Type 316 stainless steel for seaside applications

This screw is also available collated for the Quik Drive® system. See p. 257 for details.

Flat-Head

Type 316 Stainless Steel

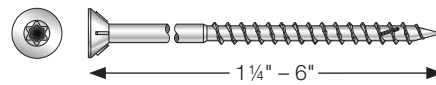

Size	Length (in.)	Head Diameter (in.)	Bit Size	Approx. Count Per lb.	1 lb. Model No.	5 lb. Model No.	Deck Pack		Bulk Bucket	
							Count	Model No.	Count	Model No.
#8	1 ¼	0.34	T20	176	T08125WP1	T08125WP5	—	—	5,000	T08125WPB
#8	1 ½	0.34	T20	150	T08162WP1	—	350	T08162WPP	4,000	T08162WPB
#8	2	0.34	T20	128	T08200WP1	T08200WP5	350	T08200WPP	3,000	T08200WPB
#8	2 ½	0.34	T20	102	T08250WPF1	T08250WPF5	—	—	1,750	T08250WPFB
#8	3	0.34	T20	82	T08300WPF1	T08300WPF5	—	—	1,750	T08300WPFB
#10	2	0.34	T25	96	T10200WP1	T10200WP5	—	—	2,500	T10200WPB
#10	2 ½	0.34	T25	82	T10250WP1	T10250WP5	350	T10250WPP	1,750	T10250WPB
#10	3	0.34	T25	68	T10300WP1	T10300WP5	350	T10300WPP	1,750	T10300WPB
#10	3 ½	0.34	T25	56	T10350WP1	—	250	T10350WPP	1,000	T10350WPB
#10	4 ½	0.34	T25	43	—	—	—	—	1,000	T10450WPCM
#12	2 ½	0.44	T27	56	T12250WP1	T12250WP5	—	—	1,750	T12250WPB
#12	3	0.44	T27	48	T12300WP1	T12300WP5	—	—	1,500	T12300WPB
#12	3 ½	0.44	T27	42	T12350WP1	T12350WP5	—	—	1,000	T12350WPB
#12	4	0.44	T27	36	T12400WP1	T12400WP5	100	T12400WPP	750	T12400WPB
#12	4 ½	0.44	T27	32	T12450WP1	T12450WP5	—	—	750	T12450WPB
#12	5	0.44	T27	29	T12500WP1	T12500WP5	—	—	500	T12500WPB
#12	6	0.44	T27	24	T12600WP1	T12600WP5	—	—	600	T12600WPB
#14	3	0.46	T27	36	T14300WP1	T14300WP5	—	—	1,000	T14300WPB
#14	3 ½	0.46	T27	33	T14350WP1	T14350WP5	—	—	750	T14350WPB
#14	4	0.46	T27	26	—	T14400WP5	100	T14400WPP	700	T14400WPB
#14	5	0.46	T27	21	T14500WP1	T14500WP5	—	—	500	T14500WPB
#14	6	0.46	T27	18	T14600WP1	T14600WP5	—	—	500	T14600WPB

6-lobe bit replacements: T20 uses BIT20T-2; T25 uses BIT25T-2; T27 uses BIT27T-2.

Exterior Wood Screws

Deck-Drive™

DWP WOOD SS Screw (cont.)

Decking, Docks and Boardwalks; Finishing, Millwork and Trim

Flat-Head

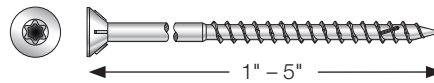

Type 305 Stainless Steel

Size	Length (in.)	Head Diameter (in.)	Bit Size	Approx. Count Per lb.	1 lb. Model No.	5 lb. Model No.	Deck Pack		Bulk Bucket	
							Count	Model No.	Count	Model No.
#8	1¼	0.34	T20	176	S08125WP1	S08125WP5	—	—	5,000	S08125WPB
#8	1⅝	0.34	T20	150	S08162WP1	S08162WP5	350	S08162WPP	4,000	S08162WPB
#8	2	0.34	T20	128	S08200WP1	S08200WP5	350	S08200WPP	3,000	S08200WPB
#8	2½	0.34	T20	102	S08250WPF1	S08250WPF5	—	—	1,750	S08250WPFB
#8	3	0.34	T20	82	S08300WPF1	S08300WPF5	—	—	1,750	S08300WPFB
#10	1	0.34	T25	172	S10100WP1	S10100WP5	—	—	4,500	S10100WPB
#10	1½	0.34	T25	134	S10150WP1	S10150WP5	—	—	3,500	S10150WPB
#10	2	0.34	T25	96	S10200WP1	S10200WP5	—	—	2,500	S10200WPB
#10	2½	0.34	T25	82	S10250WP1	S10250WP5	350	S10250WPP	1,750	S10250WPB
#10	3	0.34	T25	68	S10300WP1	S10300WP5	350	S10300WPP	1,750	S10300WPB
#10	3½	0.34	T25	56	S10350WP1	S10350WP5	—	—	1,000	S10350WPB
#12	2½	0.44	T27	56	S12250WP1	S12250WP5	—	—	1,750	S12250WPB
#12	3	0.44	T27	48	S12300WP1	S12300WP5	—	—	1,500	S12300WPB
#12	3½	0.44	T27	42	S12350WP1	S12350WP5	—	—	1,000	S12350WPB
#12	4	0.44	T27	36	S12400WP1	S12400WP5	100	S12400WPP	800	S12400WPB
#12	4½	0.44	T27	32	S12450WP1	S12450WP5	—	—	750	S12450WPB
#12	5	0.44	T27	29	S12500WP1	S12500WP5	—	—	500	S12500WPB
#14	4	0.46	T27	26	—	S14400WP5	100	S14400WPP	700	S14400WPB

6-lobe bit replacements: T20 uses BIT20T-2; T25 uses BIT25T-2; T27 uses BIT27T-2.

Exterior Wood Screws

Deck-Drive™ DWP WOOD SS Screw (cont.)

Decking, Docks and Boardwalks; Finishing, Millwork and Trim

Trim-Head, Unpainted

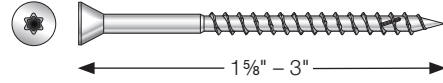

Type 316 Stainless Steel

Size	Length (in.)	Head Diameter	Bit Size	Approx. Count Per lb.	1 lb. Model No.	5 lb. Model No.	Clam Shell		350-Count Model No.	Bulk Bucket	
							Count	Model No.		Count	Model No.
#7	1 5/8	0.23	T15	195	T07162WP1	T07162WP5	100	T07162FWP	T07162WPP	4,000	T07162WPB
#7	2 1/4	0.23	T15	138	T07225WP1	T07225WP5	86	T07225FWP	T07225WPP	1,750	T07225WPB
#7	3	0.23	T15	98	T07300WP1	T07300WP5	60	T07300FWP	T07300WPP	1,750	T07300WPB

Trim-Head, Unpainted

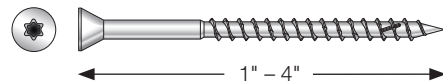

Type 305 Stainless Steel

Size	Length (in.)	Head Diameter (in.)	Bit Size	Approx. Count Per lb.	1 lb. Model No.	5 lb. Model No.	Clam Shell		350-Count Model No.	Bulk Bucket	
							Count	Model No.		Count	Model No.
#7	1	0.23	T15	303	S07100WP1	S07100WP5	—	—	—	5,000	S07100WPB
#7	1 1/4	0.23	T15	264	S07125WP1	S07125WP5	—	—	S07125WPP	5,000	S07125WPB
#7	1 5/8	0.23	T15	195	S07162WP1	S07162WP5	135	S07162FWP	S07162WPP	4,000	S07162WPB
#7	2	0.23	T15	156	S07200WP1	S07200WP5	—	—	S07200WPP	4,000	S07200WPB
#7	2 1/4	0.23	T15	138	S07225WP1	S07225WP5	100	S07225FWP	S07225WPP	1,750	S07225WPB
#7	2 1/2	0.23	T15	121	S07250WP1	S07250WP5	—	—	S07250WPP	1,750	S07250WPB
#7	3	0.23	T15	98	S07300WP1	S07300WP5	60	S07300FWP	S07300WPP	1,750	S07300WPB
#8	2 1/2	0.25	T20	109	—	—	70	S08250FWP	S08250WPP	1,750	S08250WPB
#8	3	0.25	T20	91	—	—	70	S08300FWP	S08300WPP	1,750	S08300WPB
#9	3 1/2	0.25	T20	70	S09350WP1	S09350WP5	35	S09350FWP	—	1,500	S09350WPB
#9	4	0.25	T20	61	S09400WP1	S09400WP5	—	—	—	1,000	S09400WPB

6-lobe bit replacements: T15 uses BIT15T-2; T20 uses BIT20T-2.

Trim-Head, Painted

- Painted heads blend with hardwood decking material

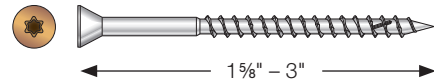

Type 316 Stainless Steel

Size	Length (in.)	Head Diameter* (in.)	Bit Size	350-Count Model No.	1750-Count Model No.
#7	1 5/8	0.23	T15	T07162WJI	T07162WCI
#7	2 1/4	0.23	T15	T07225WJI	T07225WCI
#7	3	0.23	T15	T07300WJI	T07300WCI



* T-15 6-lobe drive (replacement bit model BIT15T-2, see p. 111 for more information).

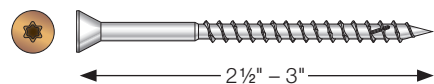

Type 305 Stainless Steel

Size	Length (in.)	Head Diameter* (in.)	Bit Size	350-Count Model No.	1750-Count Model No.
#8	2 1/2	0.26	T20	S08250WJI	S08250WCI
#10	2 1/2	0.34	T25	S10250WJI	S10250WCI
#10	3	0.34	T25	S10300WJI	S10300WCI



Exterior Wood Screws

Deck-Drive™ DHPD HARDWOOD Screw

Hardwood Decking, Docks and Boardwalks

The Deck-Drive™ DHPD Hardwood screw is specially designed to penetrate the hardest wood products with ease. With its unique paddle-style drill point, it virtually eliminates splitting without predrilling. The wings on the shaft counterbore hard material, allowing the head to countersink easily for a clean, finished look. Available in Type 305 stainless steel for additional corrosion protection.

Features:

- Penetrate the hardest wood products without predrilling
- Compact head ensures a low-profile installation and reduced visibility
- Wings on the shaft counter-bore hard material and allow the head to countersink for a clean look
- Driver bit included in each package
- #2 square drive (replacement bit model BIT2S-2, see p. 111 for more information)

This screw is also available collated for the Quik Drive® system. See p. 257 for details.

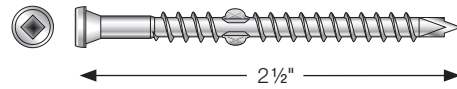

Type 305 Stainless Steel

Size	Length (in.)	Head Diameter (in.)	100-Count Model No.	350-Count Model No.	1,000-Count Model No.	1,750-Count Model No.
#10	2½	0.30	DHPDSS212R100	DHPDSS212R350	DHPDSS212R1000	DHPDSS212MB

Exterior Wood Screws

Bugle-Head Wood Screw — 6-Lobe Drive

Common Application:

Fasten all types of wood decking including cedar, redwood and preservative-treated woods

Features:

- Available in Types 316 and 305 stainless steel
- Type-17 point for fast starts
- Coarse threads on approximately $\frac{2}{3}$ of the shank draw the decking and other material tightly to the framing
- 6-lobe drive helps prevent driver-bit cam-out, resulting in easier driving and longer bit life
- 350-count packs contain enough screws to fasten 100 sq. ft. of decking (6" nominal-width boards installed on 16" o.c. joists)
- Choose Type 316 for seaside applications and superior corrosion resistance
- Driver bit included in each package
- Pre-drilling recommended near board ends to prevent splitting
- #6 screws: T-15 6-lobe drive (replacement bit model BIT15T-2)
- #8 screws: T-20 6-lobe drive (replacement bit model BIT20T-2)
- #10 screws: T-25 6-lobe drive (replacement bit model BIT25T-2)
- See p. 111 for information on replacement driver bits

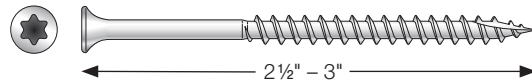

Type 316 Stainless Steel

Size	Length (in.)	Head Diameter (in.)	Approx. Count per lb.	1 lb. Model No.	5 lb. Model No.	350-Count Model No.	Bulk Bucket	
							Count	Model No.
#10	2½	0.34	82	T10250DT1	T10250DT5	—	2,000	T10250DTB
#10	3	0.34	68	T10300DT1	T10300DT5	—	1,500	OT10300DTB

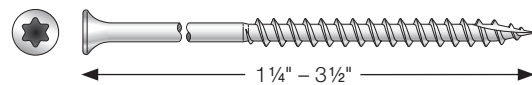

Type 305 Stainless Steel

Size	Length (in.)	Head Diameter (in.)	Approx. Count per lb.	1 lb. Model No.	5 lb. Model No.	350-Count Model No.	Bulk Bucket	
							Count	Model No.
#6	1¼	0.34	243	S06125DT1	S06125DT5	—	5,000	S06125DTB
#8	1¾	0.34	150	S08162DT1	S08162DT5	—	4,000	S08162DTB
#8	2	0.34	128	S08200DT1	S08200DT5	—	3,000	S08200DTB
#10	2½	0.34	82	S10250DT1	S10250DT5	S10C250DTP	2,000	S10250DTB
#10	3	0.34	68	S10300DT1	S10300DT5	S10C300DTP	1,500	S10300DTB
#10	3½	0.34	56	S10350DT1	S10350DT5	—	1,000	S10350DTB

Exterior Wood Screws

Bugle-Head Wood Screw — Square Drive

Common Application:

Fasten all types of wood decking including cedar, redwood and preservative-treated woods

Features:

- Available in Types 316 and 305 stainless steel
- Type-17 point for fast starts
- Coarse threads approximately $\frac{2}{3}$ up the shank draw the decking and other material tightly to the substrate
- 350-count packs contain enough screws to fasten 100 sq. ft. of decking (6" nominal-width boards installed on 16" o.c. joists)
- Choose Type 316 stainless steel for seaside applications and superior corrosion resistance
- Driver bit included in each package
- Pre-drilling recommended near board ends to prevent splitting
- #6, #8 and #10 screws: #2 square drive (replacement bit model BIT2S-2)
- #12 and #14 screws: #3 square drive (replacement bit model BIT3S-2)
- See p. 111 for information on replacement driver bits

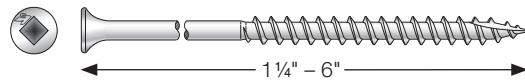

Type 316 Stainless Steel

Size	Length (in.)	Head Diameter (in.)	Approx. Count per lb.	1 lb. Model No.	5 lb. Model No.	350-Count Model No.	Bulk Bucket	
							Count	Model No.
#8	1¼	0.34	185	T08125DB1	T08125DB5	—	5,000	T08125DBB
#8	1½	0.34	150	T08162DB1	T08162DB5	—	4,000	T08162DBB
#8	2	0.34	128	T08200DB1	T08200DB5	T08C200PAK	3,000	T08200DBB
#8	2½	0.34	102	T08250DB1	T08250DB5	—	2,000	T08250DBB
#10	2	0.34	96	T10200DB1	T10200DB5	—	2,500	T10200DBB
#10	2½	0.34	82	T10250DB1	T10250DB5	T10C250PAK	2,000	T10250DBB
#10	3	0.34	68	T10300DB1	T10300DB5	T10C300PAK	1,500	T10300DBB
#10	3½	0.34	56	T10350DB1	T10350DB5	—	1,000	T10350DBB
#12	2½	0.43	56	—	—	—	2,000	T12250DBB
#12	3	0.43	48	—	—	—	1,500	T12300DBB
#12	3½	0.43	42	—	—	—	1,000	T12350DBB
#12	4	0.43	36	—	T12400DB5	—	800	T12400DBB
#12	4½	0.43	32	—	—	—	750	T12450DBB
#12	5	0.43	29	—	T12500DB5	—	500	T12500DBB
#12	6	0.43	24	—	T12600DB5	—	600	T12600DBB
#14	4	0.43	26	T14400DB1	T14400DB5	—	700	T14400DBB
#14	5	0.43	21	T14500DB1	T14500DB5	—	500	T14500DBB
#14	6	0.43	18	T14600DB1	T14600DB5	—	500	T14600DBB

Exterior Wood Screws

Bugle-Head Wood Screw — Square Drive (cont.)

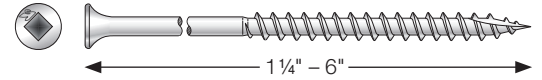

Type 305 Stainless Steel

Size	Length (in.)	Head Diameter (in.)	Approx. Count per lb.	Clam Shell		1 lb. Model No.	5 lb. Model No.	350-Count Model No.	Bulk Bucket	
				Count	Model No.				Count	Model No.
#6	3/4	0.34	352	—	—	—	—	—	10,000	S06075DBB
#6	1	0.34	295	—	—	S06100DB1	S06100DB5	—	8,000	S06100DBB
#6	1 1/4	0.34	243	175	S06C125DBP	S06125DB1	S06125DB5	—	5,000	S06125DBB
#6	1 3/8	0.34	195	135	S06C162DBP	S06162DB1	S06162DB5	—	4,000	S06162DBB
#8	1 1/8	0.34	226	—	—	S08112DB1	S08112DB5	—	5,000	S08112DBB
#8	1 1/4	0.34	185	100	S08125DBH	S08125DB1	S08125DB5	—	5,000	S08125DBB
#8	1 3/8	0.34	150	—	—	S08162DB1	S08162DB5	—	4,000	S08162DBB
#8	2	0.34	128	85	S08C200DBP	S08200DB1	S08200DB5	—	3,000	S08200DBB
#8	2 1/4	0.34	109	—	—	S08225DB1	S08225DB5	—	3,000	S08225DBB
#8	2 1/2	0.34	102	—	—	S08250DB1	S08250DB5	—	2,000	S08250DBB
#8	3	0.34	82	—	—	S08300DB1	S08300DB5	—	1,500	S08300DBB
#10	1	0.34	172	—	—	S10100DB1	S10100DB5	—	4,500	S10100DBB
#10	1 1/4	0.34	153	—	—	S10125DB1	S10125DB5	—	4,000	S10125DBB
#10	1 1/2	0.34	134	—	—	S10150DB1	S10150DB5	—	3,500	S10150DBB
#10	1 3/4	0.34	115	—	—	S10175DB1	S10175DB5	—	3,000	S10175DBB
#10	2	0.34	96	—	—	S10200DB1	S10200DB5	—	2,500	S10200DBB
#10	2 1/4	0.34	88	—	—	S10225DB1	S10225DB5	—	2,000	S10225DBB
#10	2 1/2	0.34	82	50	S10C250DBP	S10250DB1	S10250DB5	S10C250PAK	2,000	S10250DBB
#10	3	0.34	68	40	S10C300DBP	S10300DB1	S10300DB5	S10C300PAK	1,500	S10300DBB
#10	3 1/2	0.34	56	35	S10C350DBP	S10350DB1	S10350DB5	—	1,000	S10350DBB
#10	3 3/4	0.34	54	—	—	S10375DB1	S10375DB5	—	1,000	S10375DBB
#12	2 1/2	0.43	56	—	—	—	—	—	2,000	S12250DBB
#12	3	0.43	48	—	—	—	—	—	1,500	S12300DBB
#12	3 1/2	0.43	42	—	—	—	—	—	1,000	S12350DBB
#12	4	0.43	36	—	—	—	—	—	800	S12400DBB
#12	4 1/2	0.43	32	—	—	—	—	—	750	S12450DBB
#12	5	0.43	29	—	—	—	—	—	500	S12500DBB
#12	6	0.43	24	—	—	—	S12600DB5	—	600	S12600DBB
#14	4	0.43	26	—	—	S14400DB1	S14400DB5	—	700	S14400DBB
#14	5	0.43	21	—	—	S14500DB1	S14500DB5	—	500	S14500DBB

Exterior Wood Screws

Trim-Head Screw — Square Drive

Common Application:

Fasten wood decking and some composite decking materials

Features:

- Trim-style head is less noticeable on the decking surface
- Type-17 point for fast starts
- Coarse threads on approximately $\frac{2}{3}$ of the shank draw the decking and other material tightly to the framing
- Driver bit included in each package
- 350-count packs contain enough screws to fasten 100 sq. ft. of decking (6" nominal-width boards installed on 16" o.c. joists)
- Choose Type 316 stainless steel for seaside applications and superior corrosion resistance
- Pre-drilling recommended near board ends to prevent splitting
- See p. 111 for more information on bits

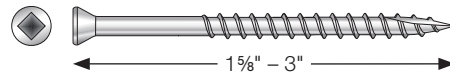

Type 316 Stainless Steel

Size	Length (in.)	Head Diameter (in.)	Approx. Count per lb.	1 lb. Model No.	5 lb. Model No.	350-Count Model No.	Bulk Bucket	
							Count	Model No.
#7	1½	0.23	195	T07162FB1	T07162FB5	T07C162PAK	4,000	T07162FBB
#7	2¼	0.23	138	T07225FB1	T07225FB5	T07C225PAK	3,000	T07225FBB
#7	3	0.23	98	T07300FB1	T07300FB5	T07C300PAK	2,000	T07300FBB

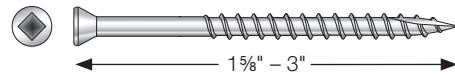

Type 305 Stainless Steel

Size	Length (in.)	Head Diameter (in.)	Approx. Count per lb.	1 lb. Model No.	5 lb. Model No.	Clam Shell		350-Count Model No.	Bulk Bucket	
						Count	Model No.		Count	Model No.
#7	1½	0.23	195	S07162FB1	S07162FB5	135	S07C162FBP	S07C162PAK	4,000	S07162FBB
#7	2¼	0.23	138	S07225FB1	S07225FB5	100	S07C225FBP	S07C225PAK	3,000	S07225FBB
#7	3	0.23	98	S07300FB1	S07300FB5	60	S07C300FBP	S07C300PAK	2,000	S07300FBB

Exterior Wood Screws

Trim-Head Screw — 6-Lobe Drive

Common Application:

Fasten wood decking and some composite decking materials

Features:

- Trim-style head is less noticeable on the decking surface
- Type-17 point for fast starts
- Coarse threads on approximately 2/3 of the shank draw the decking and other material tightly to the framing
- 6-lobe drive helps prevent driver-bit cam-out, resulting in easier driving and longer bit life
- 350-count packs contain enough screws to fasten 100 sq. ft. of decking (6" nominal-width boards installed on 16" o.c. joists)
- Choose Type 316 for seaside applications and superior corrosion resistance
- Pre-drilling recommended near board ends to prevent splitting
- T-15 6-lobe drive (replacement bit model BIT15T-2, see p. 111 for more information)

Painted

- Heads painted for a concealed appearance
- See pp. 24–25 for Color Reference Chart for Decking Manufacturers

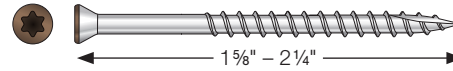

Type 316 Stainless Steel

Size	Length (in.)	Head Dia. (in.)	Head Color	Approx. Count per lb.	1 lb. Model No.	5 lb. Model No.	350-count	1,750-count
#7	1 5/8	0.23	Black	195	—	—	T07162FTPBK	T07162FTBBK
#7	1 5/8	0.23	Brown 01	195	—	—	T07162FTPBR01	T07162FTBBR01
#7	1 5/8	0.23	Gray	195	—	—	T07162FTPGR	T07162FTBGR
#7	1 5/8	0.23	Gray 01	195	—	—	T07162FTPGR01	T07162FTBGR01
#7	1 5/8	0.23	Tan 02	195	—	—	T07162FTPTN02	T07162FTBTN02
#7	1 5/8	0.23	White	195	T07162FT1WH01	T07162FT5WH01	T07162FTPWH01	T07162FTBWH01
#7	2 1/4	0.23	Brown 01	138	—	—	T07225FTPBR01	T07225FTBBR01
#7	2 1/4	0.23	Brown 05	138	—	—	T07225FTPBR05	T07225FTBBR05
#7	2 1/4	0.23	Gray	138	—	—	T07225FTPGR	T07225FTBGR
#7	2 1/4	0.23	Gray 01	138	—	—	T07225FTPGR01	T07225FTBGR01
#7	2 1/4	0.23	Gray 03	138	—	—	T07225FTPGR03	T07225FTBGR03
#7	2 1/4	0.23	Gray 04	138	—	—	T07225FTPGR04	T07225FTBGR04
#7	2 1/4	0.23	Red 01	138	—	—	T07225FTPRD01	T07225FTBRD01
#7	2 1/4	0.23	Tan	138	—	—	T07225FTPTN	T07225FTBTN
#7	2 1/4	0.23	Tan 01	138	—	—	T07225FTPTN01	T07225FTBTN01
#7	2 1/4	0.23	Tan 02	138	—	—	T07225FTPTN02	T07225FTBTN02
#7	2 1/4	0.23	Tan 03	138	—	—	T07225FTPTN03	T07225FTBTN03
#7	2 1/4	0.23	Tan 04	138	—	—	T07225FTPTN04	T07225FTBTN04
#7	2 1/4	0.23	White	138	T07225FT1WH01	T07225FT5WH01		T07225FTBWH01

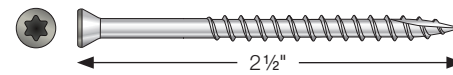

Type 305 Stainless Steel

Size	Length (in.)	Head Dia. (in.)	Head Color	Approx. Count per lb.	1 lb. Model No.	5 lb. Model No.	350-count	1,750-count
#7	1 5/8	0.23	White	138	S07162FT1WH01	S07162FT5WH01	—	—
#7	2 1/4	0.23	Brown 01	138	—	—	S07225FTPBR01	S07225FTBBR01
#7	2 1/4	0.23	Brown 05	138	—	—	S07225FTPBR05	S07225FTBBR05
#7	2 1/4	0.23	Gray	138	—	—	S07225FTPGR	S07225FTBGR
#7	2 1/4	0.23	Gray 01	138	—	—	S07225FTPGR01	S07225FTBGR01
#7	2 1/4	0.23	Gray 03	138	—	—	S07225FTPGR03	S07225FTBGR03
#7	2 1/4	0.23	Gray 04	138	—	—	S07225FTPGR04	S07225FTBGR04
#7	2 1/4	0.23	Red 01	138	—	—	S07225FTPRD01	S07225FTBRD01
#7	2 1/4	0.23	Tan	138	—	—	S07225FTPTN	S07225FTBTN
#7	2 1/4	0.23	Tan 01	138	—	—	S07225FTPTN01	S07225FTBTN01
#7	2 1/4	0.23	Tan 02	138	—	—	S07225FTPTN02	S07225FTBTN02
#7	2 1/4	0.23	Tan 04	138	—	—	S07225FTPTN04	S07225FTBTN04
#7	2 1/4	0.23	White	138	S07225FT1WH01	S07225FT5WH01		S07225FTBWH01



C-F-2017 © 2017 SIMPSON STRONG-TIE COMPANY INC.

Screws

Exterior Wood Screws

Trim-Head Screw — 6-Lobe Drive (cont.)

Unpainted

Type 316 Stainless Steel

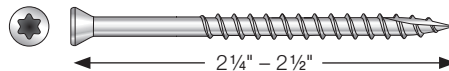

Size	Length (in.)	Head Diameter (in.)	Approx. Count per lb.	1 lb. Model No.	5 lb. Model No.	350-Count Model No.	Bulk Bucket	
							Count	Model No.
#7	2¼	0.23	138	—	—	—	3,000	T07225FTB
#8	2½	0.23	126	T08250FT1	T08250FT5	—	2,000	T08250FTB

Type 305 Stainless Steel

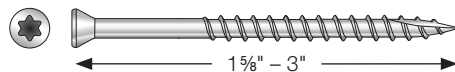

Size	Length (in.)	Head Diameter (in.)	Approx. Count per lb.	1 lb. Model No.	5 lb. Model No.	350-Count Model No.	Bulk Bucket	
							Count	Model No.
#7	1⅝	0.23	195	S07162FT1	S07162FT5	S07C162FTP	4,000	S07162FTB
#7	2¼	0.23	138	S07225FT1	S07225FT5	S07225FTP	3,000	S07225FTB
#7	3	0.23	98	S07300FT1	S07300FT5	S07C300FTP	2,000	S07300FTB

Composite Decking Screws

Deck-Drive™ DCU COMPOSITE Screw

Fastening Composite Decking Boards

The Deck-Drive™ DCU composite screw is engineered to provide beautiful fastening results for all types of composite decking while also offering greater ease of installation, a clean finish and superb corrosion resistance. The Deck-Drive DCU is the go-to-screw for all your composite decking applications, eliminating the need to mix and match screws to the decking they are suited for.

Deck-Drive DCU composite decking screws are available in carbon steel with our Quik Guard® coating. For superior corrosion resistance in marine or high-exposure environments, choose the appropriate stainless-steel DCU screw (Type 305 or Type 316). DCU screws provide a clean finish because of their special head design and are available in 11 colors, matched to blend with most major decking manufacturers. These are bulk screws, also available collated for the Quik Drive® auto-feed screw driving system.

Features:

- Available in carbon steel, as well as Type 305 and Type 316 stainless steel for high to severe levels of corrosion resistance
- Tri-lobe thread design reduces damage to the composite board while driving
- Inverted upper threads clear excess material to ensure the screw is seated properly and consistently
- Double-cut point penetrates composite-decking with ease for faster starts
- Cap-head prevents mushrooming and material from rising up above the deck for a smoother, clean-looking installation
- Approved fastener (by Trex®) for Trex® composite decking
- This screw is also available collated for the Quik Drive® system; see p. 265 for details
- Refer to pp. 24–25 for color matching information

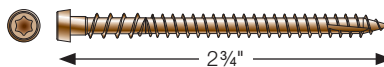

Carbon Steel, Quik Guard® Coating

Size	Length	Color	Deck Pack (350ct) ¹	Contractor Bucket (1,750 ct) ²
#10	2 3/4"	Tan	DCU234TNR350	DCU234TNMB
#10	2 3/4"	Tan 01	DCU234TN01R350	DCU234TN01MB
#10	2 3/4"	Tan 02	DCU234TN02R350	DCU234TN02MB
#10	2 3/4"	Tan 03	DCU234TN03R350	DCU234TN03MB
#10	2 3/4"	Gray	DCU234GRR350	DCU234GRMB
#10	2 3/4"	Gray 01	DCU234GR01R350	DCU234GR01MB
#10	2 3/4"	Gray 04	DCU234GR04R350	DCU234GR04MB
#10	2 3/4"	Brown 01	DCU234BR01R350	DCU234BR01MB
#10	2 3/4"	Brown 05	DCU234BR05R350	DCU234BR05MB
#10	2 3/4"	Red	DCU234RDR350	DCU234RDMB
#10	2 3/4"	Red 01	DCU234RD01R350	DCU234RD01MB



1. 350 screws install approx. 100 sq. ft. of decking with framing at 16" on-center spacing.

2. 1,750 screws install approx. 500 sq. ft. of decking with framing at 16" on-center spacing.

Composite Decking Screws

Deck-Drive™ DCU COMPOSITE Screw (cont.)

Painted head

Type 305 Stainless Steel

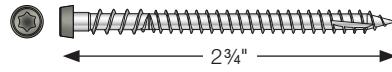

Size	Length	Head Color	Deck Pack (350ct) ¹	Contractor Bucket (1,750 ct) ²
#10	2 3/4"	—	DCU234P305	DCU234MB305
#10	2 3/4"	Tan	DCU234P305TN	DCU234MB305TN
#10	2 3/4"	Tan 01	DCU234P305TN01	DCU234MB305TN01
#10	2 3/4"	Tan 02	DCU234P305TN02	DCU234MB305TN02
#10	2 3/4"	Tan 03	DCU234P305TN03	DCU234MB305TN03
#10	2 3/4"	Gray	DCU234P305GR	DCU234MB305GR
#10	2 3/4"	Gray 01	DCU234P305GR01	DCU234MB305GR01
#10	2 3/4"	Gray 04	DCU234P305GR04	DCU234MB305GR04
#10	2 3/4"	Brown 01	DCU234P305BR01	DCU234MB305BR01
#10	2 3/4"	Brown 05	DCU234P305BR05	DCU234MB305BR05
#10	2 3/4"	Red	DCU234P305RD	DCU234MB305RD
#10	2 3/4"	Red 01	DCU234P305RD01	DCU234MB305RD01



Type 316 Stainless Steel

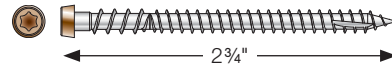

Size	Length	Head Color	Deck Pack (350ct) ¹	Contractor Bucket (1,750 ct) ²
#10	2 3/4"	—	DCU234P316	DCU234MB316
#10	2 3/4"	Tan	DCU234P316TN	DCU234MB316TN
#10	2 3/4"	Tan 01	DCU234P316TN01	DCU234MB316TN01
#10	2 3/4"	Tan 02	DCU234P316TN02	DCU234MB316TN02
#10	2 3/4"	Tan 03	DCU234P316TN03	DCU234MB316TN03
#10	2 3/4"	Gray	DCU234P316GR	DCU234MB316GR
#10	2 3/4"	Gray 01	DCU234P316GR01	DCU234MB316GR01
#10	2 3/4"	Gray 04	DCU234P316GR04	DCU234MB316GR04
#10	2 3/4"	Brown 01	DCU234P316BR01	DCU234MB316BR01
#10	2 3/4"	Brown 05	DCU234P316BR05	DCU234MB316BR05
#10	2 3/4"	Red	DCU234P316RD	DCU234MB316RD
#10	2 3/4"	Red 01	DCU234P316RD01	DCU234MB316RD01



1. 350 screws install approx. 100 sq. ft. of decking with framing at 16" on-center spacing.
2. 1,750 screws install approx. 500 sq. ft. of decking with framing at 16" on-center spacing.

Composite Decking Screws

Dexxter™ Composite-Decking Screw

The Dexxter™ Composite-Decking screw is designed to ease installation and offer a cleaner, less noticeable fastening solution for composite and encapsulated-composite decking. Available in stainless steel for corrosion resistance. Choose Type 316 stainless steel for seaside and coastal environments.

Features:

- Unique thread formation removes excess decking material to ensure the screw is seated properly and consistently
- The trim-pan head reduces the mushroom effect, common with traditional decking screws, leaving a smoother, clean-looking installation
- Type-17 point easily pierces composite substrate for faster starts
- Head style minimizes visibility on the decking surface
- Driver bit included in every package
- T-20 6-lobe drive (replacement driver bit – BIT20T-2)

U.S. Patent 7,402,016

6-Lobe Drive

Type 316 Stainless Steel

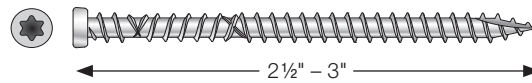

Size	Length (in.)	350-Count Model No.	1,750-Count Model No.
#10	2½	T10250DXP	T10250DXB
#10	3	T10300DXP	T10300DXB

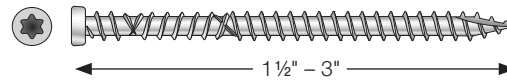

Type 305 Stainless Steel

Size	Length (in.)	70-Count Model No.	350-Count Model No.	1,750-Count Model No.
#10	1½	S10150DXC	S10150DXP	S10150DXB
#10	2	—	S10200DXP	S10200DXB
#10	2½	S10250DXC	S10250DXP	S10250DXB
#10	3	S10300DXC	S10300DXP	S10300DXB

Interior Wood Screws

Strong-Drive® SDWC TRUSS Screw

Truss/Rafter-to-Plate and Stud-to-Plate Connections

The Strong-Drive® SDWC Truss screw provides a stud-to-bottom plate or stud-to-top plate connection as well as fastening trusses and rafters to top plates. The full-threaded shank engages the entire length of the fastener, providing a secure connection. The SDWC is tested in accordance with ICC-ES AC233 (screw) and AC13 (wall assembly and roof-to-wall assembly) for uplift and lateral loads between wall plates and vertical wall framing and between the top plate and the roof rafters or trusses. It is code listed under IAPMO-UES ER-192 and meets 2012 and 2015 IRC® and IBC® code requirements for several common wood framing applications.

Features:

- Fully-threaded shank engages the entire length of the fastener, providing a secure connection between the roof and wall framing members
- Cap-style head countersinks fully into the double top plate to avoid interference with drywall or finish trades
- Wide tolerance on installation angle makes it easy to install the SDWC correctly
- Can be installed from inside the structure, eliminating exterior work on the upper stories and enhancing job safety
- Fastening can be performed before or after exterior sheathing is applied for added flexibility
- Metal installation guide tool (included) to help ensure proper installation
- Matched-tolerance driver bit (included) engages fastener head securely to allow one-handed driving (replacement bit part no. BIT30T-2-RC3)
- Orange color for easy inspection
- Type-17 point for faster starts and easier driving
- SDWC15450 is recognized for use in chemically treated wood as described in the evaluation report

Codes/Standards: IAPMO-UES ER-262, State of Florida FL13975

For Technical Data and Loads, see pp. 340–351

SDWC15450-KT and SDWC15600-KT contains:

- (50) Strong-Drive® SDWC screws
- (1) Matched-tolerance driver bit (Part no. BIT30T-2-RC3; also sold separately)
- (1) Metal installation guide tool
 - SDWC-GUIDE (for SDWC15600 only; also sold separately) or
 - SDWC-GUIDE275 (for SDWC15450 only; also sold separately)



SDWC15450B-KT and SDWC15600B-KT contains:

- (500) Strong-Drive® SDWC screws
- (2) Matched-tolerance driver bits (Part no. BIT30T-2-RC3; also sold separately)
- (2) Metal installation guide tools
 - SDWC-GUIDE (for SDWC15600 only; also sold separately) or
 - SDWC-GUIDE275 (for SDWC15450 only; also sold separately)



E-Coat

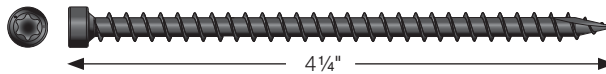

Size (in.)	Thread Length (in.)	Retail Pack ¹			Mini-Bulk Bucket ²	
		Fasteners Per Pack	Retail Per Master Carton	Model No.	Fasteners Per Bucket	Model No.
0.152 x 4 1/2	4 1/4	50	6	SDWC15450-KT	500	SDWC15450B-KT

Clear Zinc Coating (with Orange Topcoat)

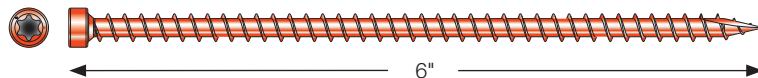

Size (in.)	Thread Length (in.)	Retail Pack ¹			Mini-Bulk Bucket ²	
		Fasteners Per Pack	Retail Per Master Carton	Model No.	Fasteners Per Bucket	Model No.
0.152 x 6	5 3/4	50	6	SDWC15600-KT	500	SDWC15600B-KT

Interior Wood Screws

Strong-Drive® SDW EWP-PLY Screw

Multi-Ply Wood Members, Engineered-Lumber Products and Solid-Sawn Lumber

The Strong-Drive® SDW EWP-Ply screw is a high-strength structural wood screw specifically designed for fastening multi-ply wood members, such as engineered-wood products and solid-sawn lumber. The SDW EWP-Ply installs easily with no pre-drilling and is available in optimized lengths for fastening 1 3/4" engineered lumber, such as structural composite lumber (SCL). The large, flush head eases the handling of assembled girders and simplifies the installation of finishes or structural connectors. It is code listed under IAPMO-UES ER-192 and meets 2012 and 2015 IRC® and IBC® code requirements for several common wood framing applications.

Features:

- Large washer head provides maximum bearing area; stamped with the Simpson Strong-Tie "S" sign and fastener length for easy identification after installation (0.75" head dia.)
- Deep 6-lobe T-40 recess reduces cam-out, making driving easier
- Low-profile head results in less interference after installation; makes stacking and sliding members easier and allows installation of hardware and finishes to be virtually flush
- Optimal screw lengths provide maximum penetration while preventing the point from protruding out the back of the member
- Specific thread lengths avoids jacking
- Higher shear values than competitive products enable wider spacing, saving time and money
- Bold thread design provides superior holding power and cinches fastened members together for consistent installation
- Patented 4CUT™ tip ensures fast starts, reduced installation torque and eliminates the need for pre-drilling in most applications
- Retail and mini-bulk packs include one 6-lobe, T-40 driver bit; bulk packs include two driver bits

Codes/Standards: IAPMO-UES ER-192; City of L.A. RR25906, State of Florida FL13975

For Technical Data and Loads, see pp. 356–363

U.S. Patents: 5,897,280; 7,101,133 and 6,109,850

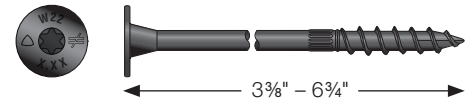

E-Coat

Size (in.)	Thread Length (in.)	Typical Application ¹	Retail Pack			Mini-Bulk Bucket		Bulk	
			Fasteners Per Pack	Packs Per Master Carton	Model No.	Fasteners Per Pack	Model No.	Fasteners Per Pack	Model No.
0.220 x 3 3/8	1 1/16	SCL	50	6	SDW22338-R50	250	SDW22338MB	900	SDW22338
0.220 x 5	1 1/16	SCL/3x2PCT	50	4	SDW22500-R50	200	SDW22500MB	600	SDW22500
0.220 x 6 3/4	1 1/16	SCL/4x2PCT	50	4	SDW22634-R50	200	SDW22634MB	500	SDW22634

1. Typical screw application key: SCL = 1 3/4" plies of structural-composite lumber. SCL/3x2PCT = 1 3/4" plies of structural-composite lumber or double 3x2 parallel-chord trusses. SCL/4x2PCT = 1 3/4" or 3 1/2" plies of structural-composite lumber or double 4x2 parallel-chord trusses.

Interior Wood Screws

Strong-Drive® SDW TRUSS-PLY Screw

Truss-Ply Fastening

The Strong-Drive® SDW Truss-Ply screw is a high-strength structural wood screw specifically designed for fastening multi-ply wood members, such as joining plated trusses and solid-sawn lumber. The SDW installs easily with no pre-drilling and is available in optimized lengths for fastening 2-, 3- and 4-ply trusses. With the SDW Truss-Ply screw, multi-ply trusses and beams can be fastened from one side without requiring the lifting and flipping of heavy assemblies. It is code listed under IAPMO-UES ER-192 and meets 2012 and 2015 IRC® and IBC® code requirements for several common wood framing applications.

Features:

- Large washer head provides maximum bearing area; stamped with the Simpson Strong-Tie “S” sign and fastener length for easy identification after installation (0.75" head dia.)
- Deep 6-lobe T-40 recess reduces cam-out, making driving easier
- Low-profile head results in less interference after installation; makes stacking and sliding members easier and allows installation of hardware and finishes to be virtually flush
- Higher shear values than competitive products enable wider spacing, saving time and money
- Bold thread design provides superior holding power and cinches fastened members together for consistent installation
- Patented 4CUT™ tip ensures fast starts, reduced installation torque and eliminates the need for pre-drilling in most applications
- Retail and mini-bulk packs include one 6-lobe, T-40 driver bit; bulk packs include two driver bits

Codes/Standards: IAPMO-UES ER-192; City of L.A. RR25906, State of Florida FL13975

For Technical Data and Loads, see pp. 356–363

U.S. Patents: 5,897,280; 7,101,133 and 6,109,850

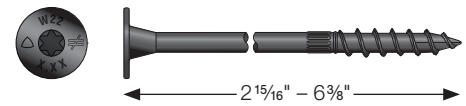

E-Coat

Size (in.)	Thread Length (in.)	Typical Application ^{1,2,3}	Retail Pack			Mini-Bulk Bucket		Bulk	
			Fasteners Per Pack	Packs Per Master Carton	Model No.	Fasteners Per Pack	Model No.	Fasteners Per Pack	Model No.
0.220 x 2 1/16	1 7/16	2x/Truss	50	6	SDW22300-R50	250	SDW22300MB	950	SDW22300
0.220 x 4 3/8	1 7/16	2x/Truss desert	50	4	SDW22438-R50	200	SDW22438MB	600	SDW22438
0.220 x 4 3/8	1 7/16	2x/Truss	50	4	SDW22458-R50	200	SDW22458MB	600	SDW22458
0.220 x 6	1 7/16	2x/Truss desert	50	4	SDW22600-R50	200	SDW22600MB	500	SDW22600
0.220 x 6 3/8	1 7/16	2x/Truss	50	4	SDW22638-R50	200	SDW22638MB	500	SDW22638

1. Typical screw application key: 2x/Truss = Solid-sawn dimensional lumber and plated wood trusses. 2x Truss Desert = Solid-sawn dimensional lumber and plated wood trusses in desert environments (scant lumber).

2. If assembly is less than or equal to 4 3/8" thick, use the SDW22438.
3. If assembly is less than or equal to 6 3/8" thick, use the SDW22600.

Strong-Drive® SDWS LOG Screw

Log Home Construction and General Interior Applications

The Strong-Drive® SDWS Log screw is a structural wood screw available in longer lengths and is designed for log-home construction and general interior applications. These 0.220" and 0.195" diameter structural fasteners require less torque to install than comparable fasteners. The large diameter head pulls logs down easily, eliminating the need to use extra washers. It is code listed under IAPMO-UES ER-192 and meets 2012 and 2015 IRC® and IBC® code requirements for several common wood framing applications.

Features:

- Patented 4CUT™ tip ensures fast starts, reduces installation torque and eliminates the need for pre-drilling in most applications
- Low-profile head design makes countersinking easy (0.75" head dia.)
- Serrated thread reduces log splitting and damage
- Large washer head provides maximum bearing area
- Deep 6-lobe T-40 recess reduces cam-out, making driving easier
- Size Identification on all SDWS screw heads

Codes/Standards: IAPMO-UES ER-192

For Technical Data and Loads, see pp. 308–310

U.S. Patents: 5,897,280; 7,101,133

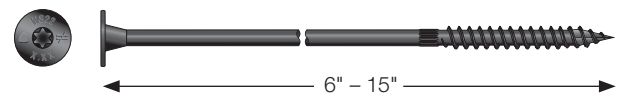

Size (in.)	Thread Length (in.)	Individually Flagged	Retail Pack			Mini-Bulk	
			Fasteners Per Pack	Packs Per Master Carton	Model No.	Fasteners Per Pack	Model No.
0.195 x 6	2 3/4	SDWS19600-RP1	45	6	SDWS19600-R50	250	SDWS19600
0.195 x 7 1/2	2 3/4	SDWS19712-RP1	45	6	SDWS19712-R50	250	SDWS19712
0.220 x 8	2 3/4	SDWS22800-RP1	40	6	SDWS22800-R50	250	SDWS22800
0.220 x 9	2 3/4	SDWS22900-RP1	40	6	SDWS22900-R50	250	SDWS22900
0.220 x 10	2 3/4	SDWS221000-RP1	40	6	SDWS221000-R50	250	SDWS221000
0.220 x 11	2 3/4	SDWS221100-RP1	40	6	SDWS221100-R50	250	SDWS221100
0.220 x 12	2 3/4	SDWS221200-RP1	40	6	SDWS221200-R50	250	SDWS221200
0.220 x 15	2 3/4	SDWS221500-RP1	40	6	SDWS221500-R50	250	SDWS221500

Replacement driver bit: BIT40T-134.

Interior Wood Screws

Strong-Drive® SDWF FLOOR-TO-FLOOR Screw

Wind-Uplift Restraint Connections

The Strong-Drive® SDWF Floor-To-Floor screw is designed to simplify the wind-uplift restraint connection while providing superior performance over the life of the structure. The unique design of the SDWF enables it to attach upper and lower walls together from the top, spanning the floor system and providing an easy-to-install connection within the continuous uplift load path of the structure.

The innovative Take-Up Washer (TUV) plays a key role in the long-term performance of the SDWF when installed between the screw head and the sole plate of the upper floor. As the structure settles because of shrinkage and construction loading, the threaded portion under the head of the screw ratchets up through the tabs of the TUV, which is fastened with Simpson Strong-Tie Strong-Drive SD screws. The interlock between the tabs of the take-up washer and the threads under the head of the SDWF prevent the screw from sliding back under load, providing a simple yet reliable means of shrinkage compensation up to 3/4" per story.

Features:

- Faster to install than other floor-to-floor connection methods — drive the screw, install the take up washer and the connection is made from plate-to-plate
- Shrinkage compensation ensures a tight connection even after initial shrinkage and settlement occur
- Installs from inside the structure, eliminating exterior work on upper stories and enhancing job safety
- Fastening can be done before or after exterior sheathing is applied for added flexibility
- One screw length can be used for multiple floor depths (refer to chart to select appropriate screw size), reducing the need for many screw lengths

Kit includes all required installation hardware:

- (25) Strong-Drive® SDWF Floor-to-Floor screw
- (25) TUV Take-Up Washers
- (100) Strong-Drive® SD Connector Screws (#9)
- 3/16" Hex Driver Bit (replacement driver bit – BITHEXR516-134)
- Screw Depth Guide to ensure proper SDWF engagement with TUV

TUV take-up washer is galvanized 10 ga. steel

Codes/Standards: ICC-ES ESR-3046 (SDWF), ICC-ES ESR-2320 (TUV), State of Florida FL9589, FL1007(TUV)

For Technical Data and Loads, see pp. 352–355

U.S. Patent: 8,276,323

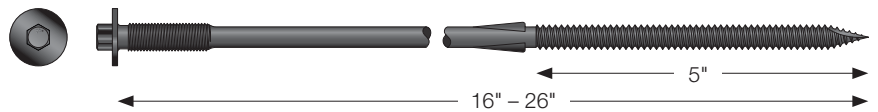

Length (in.)	Shank Diameter (in.)	Thread Length (in.)	Hex Drive (in.)	Model No.
16	0.27	5	5/16	SDWF2716-TUV
20	0.27	5	5/16	SDWF2720-TUV
24	0.27	5	5/16	SDWF2724-TUV
26	0.27	5	5/16	SDWF2726-TUV

Strong-Drive® SDWW SOLE-TO-RIM Screw

Sole-to-Rim Attachment

The Strong-Tie SDWW Sole-to-Rim screw may be used to attach a sole plate to a rim board.

Features:

- Large 0.400 diameter head for increased holding power
- Variable thread design, optimized for 2x dimensional lumber
- Fast start point with helical ridge for fast, easy, low-torque installation

US Patent 6,074,149

For Technical Data and Loads, see p. 364

Clear Zinc Coating

Size Dia. x L (in.)	Head Diameter (in.)	Shank Diameter (in.)	Coating	Quantity	Model No.
#10 x 4	0.4	0.14	Clear Zinc	1,000	SDWW13400Z

Replacement driver bit: BIT25T-2.

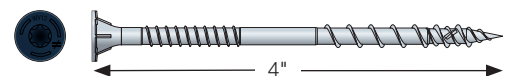

Interior Wood Screws

Strong-Drive® WSNTL SUBFLOOR Screw

Subfloor and Sheathing Projects

The ICC-ES ESR-1472 code-listed Strong-Drive® WSNTL Subfloor screw has a unique thread pattern that allows for quick and seemingly effortless installations. With lateral, shear and withdrawal values that exceed those of 10d common nails, the holding power of the WSNTL screw eliminates the gaps between the joist and subfloor that cause floor squeaks. The WSNTL Subfloor screw countersinks easily and backs out smoothly, allowing for easy future access to floor cavities.

Features:

- Deep recessed square drive holds bits tight, reducing cam-outs
- Twin-lead thread for quick installation
- Nibbed flat head for easy countersinking
- Yellow zinc coating for interior applications
- This screw is also available collated for the Quik Drive® system; see pp. 268–269 for details

Codes/Standards: ICC-ES ESR-1472

For Technical Data and Loads, see p. 366

Yellow Zinc Coating

Length (in.)	Size	Coating	Head Dia. (in.)	Drive Type	Retail Pack		Contractor Pack	
					Fasteners per Pack	Model No.	Fasteners per Pack	Model No.
2	#8	Yellow zinc	0.33	#3 square	100	WSNTL2R100	500	WSNTL2R500
2½	#8	Yellow zinc	0.33	#3 square	80	WSNTL212R80	400	WSNTL212R400
3	#8	Yellow zinc	0.33	#3 square	60	WSNTL3R60	300	WSNTL3R300

Fastener penetration into supporting member must be at least 1¼".

Replacement driver bit: BIT3S-2-RC3.

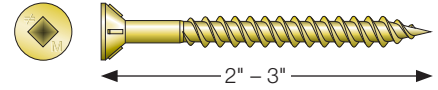

Wafer-Head Screw

Common Application:

General wood-to-wood fastening

Features:

- Wafer head
- Deep #2 Phillips drive reduces cam-out and makes driving easier
- Sharp point for fast starts
- Clear zinc electro-galvanized finish; for information on corrosion, materials and coatings, see pp. 17–21

For Technical Data and Loads, see p. 339

Clear Zinc Coating

Size	Length (in.)	Head Diameter (in.)	Carton Quantity	Model No.
#8	1¼	0.42	100	SD8x1.25-R

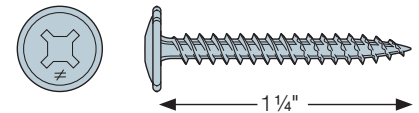

MTH Underlayment Screw

Underlayment Fastening Applications

Prevents Squeaks by Holding Underlayment Tight

The MTH Underlayment screw is designed for fast and secure underlayment to subfloor installations. Unlike nails, the MTH Underlayment screw has an intricate thread pattern designed to prevent squeaking by holding underlayment tight to the subfloor and thus preventing pull-out. Its compact trim-head allows for a flush surface and prevents floor coverings from settling in countersink recesses.

Features:

- Deep recessed square drive holds bits tight, reducing cam-outs
- High-low thread for easy driving and holding underlayment tight
- Specially-designed sharp point for fast starts
- Trim-Head with nibs for easy countersinking
- Available collated for Quik Drive® system; see p. 271 for details

Gray Phosphate

Length (in.)	Size	Coating	Head Dia. (in.)	Drive Type	Retail Pack		Contractor Pack	
					Fasteners per Pack	Model No.	Fasteners Per Pack	Model No.
1¼	#7	Gray phosphate	0.27	#2 square	250	MTH114R250	1,200	MTH114R1200

Replacement driver bit: BIT2S-2-RC3.



Metal Screws

Strong-Drive® XL LARGE-HEAD METAL Screw

Steel decking or other cold-formed steel framing; connectors to structural steel

Strong-Drive XL® Large-Head Metal screws are load-tested and code-listed, allowing you to get the for maximum load values for installation. These screws are the perfect choice when high shear or uplift resistance is required and can be excellent 1-for-1 replacements for pins.

Features:

- 5/16" hex drive (replacement driver bit – BITHEXR516-134)
- #5 drill point
- Quik Guard® coating
- 5/8" diameter integral washer
- This screw is also available collated for the Quik Drive® system; see p. 277 for details

Codes/Standards: IAPMO UES ER-326, FM Approval 3050714, State of Florida FL16937, City of Los Angeles RR26009, SDI DDM03 Appendix IX, SDI DDM04

U.S. Patent Pending

For Technical Data and Loads, see pp. 381–382

Warning: Industry studies show that hardened fasteners can experience performance problems in wet or corrosive environments. Accordingly, use this product in dry, interior and noncorrosive environments only.

For more information regarding fastening steel decking, see pp. 378-379.

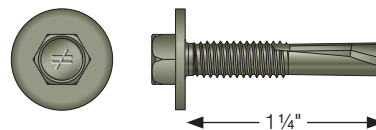

Quik Guard® Coating

Size	Length (in.)	Hex Head Size (in.)	Washer Dia. (in.)	Threads Per Inch	Point Size	Suitable Material Thickness (in.)	Bulk	
							Carton Qty.	Model No.
#12	1 1/4	5/16	0.63	24	#5	0.13–0.5	2,000	XLQ114B1224-2K

Strong-Drive® XM MEDIUM-HEAD METAL Screw

Steel decking to structural members involving wide or narrow valley; nestable or interlocking steel decking

Strong-Drive® metal screws are load-tested and code-listed, allowing you to get the maximum load values for installation. Comparison testing shows Strong-Drive® XM Medium-Head Metal screws are stronger than many alternative fastener types in 33 ksi and 50 ksi steel decking.

Features:

- 5/16" hex drive (replacement driver bit – BITHEXR516-134)
- 1/2"-dia. hex washer head is ideal for narrow-channel steel decking
- Available only in 1 1/4" length with #5 drill point
- Available in Quik Guard® coating
- This screw is also available collated for the Quik Drive® system; see p. 277 for details

Codes/Standards: IAPMO UES ER-326, FM Approval 3050714, State of Florida FL16937, City of Los Angeles RR26009, SDI DDM04

U.S. Patent Pending

For Technical Data and Loads, see pp. 381–382

Warning: Industry studies show that hardened fasteners can experience performance problems in wet or corrosive environments. Accordingly, use this product in dry, interior and noncorrosive environments only.

For more information regarding fastening steel decking, see pp. 378-379.

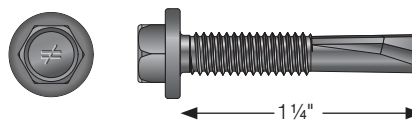

Quik Guard® Coating

Size	Length (in.)	Hex Head Size (in.)	Washer Dia. (in.)	Threads Per Inch	Point Size	Suitable Material Thickness (in.)	Bulk	
							Carton Qty.	Model No.
#12	1 1/4	5/16	0.48	24	#5	0.13–0.5	2,000	XMQ114B1224-2K

Metal Screws

Strong-Drive® XE EXTERIOR STRUCTURAL METAL Screw

For Simpson Strong-Tie® Connectors

Features:

- 5/16" hex head (replacement driver bit – BITHEXR516-134)
- 16 threads per inch
- Dual hardened heat treatment improves drilling efficiency, maximizes ductility and reduces the potential for hydrogen embrittlement
- Quik Guard® coated for corrosion protection
- Meets ASTM C1513 drill-time performance
- Only fastener load rated for Simpson Strong-Tie® L70Z and LS70Z connectors for use with Trex® Elevations™ steel deck framing

For Technical Data and Loads, see p. 370

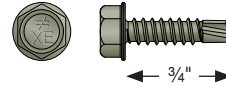

Quik Guard® Coating

Length (in.)	Screw Size/ Nail Gauge	Shank Dia. (in.)	Head Dia. (in.)	Drive	Head Type	Threads	Point	Point Size	Material/ Coating	Package Size	Model No.
3/4	#10	0.19	0.4	5/16" hex	Hex washer head	Machine threads	#2 drill point	2	Quik Guard® coating	100	XEQ34B1016C
3/4	#10	0.19	0.4	5/16" hex	Hex washer head	Machine threads	#2 drill point	2	Quik Guard® coating	1,000	XEQ34B1016M

Strong-Drive® SELF-DRILLING X METAL Screw

Common Applications:

1. Steel decking to structural steel; 2. Steel stitching ("side-lap" stitching); 3. Cold-formed steel framing

Features:

- 5/16" hex head (replacement driver bit – BITHEXR516-134)
- Drill point
- Hex-washer head
- Also available collated for the Quik Drive® system; see p. 278 for details

Codes/Standards: IAPMO UES ER-326, ICC-ES ESR-3006, City of LA RR26009, RR25670, SDI DDM03 Appendix VII and DDM04, State of Florida FL16937

Warning: Industry studies show that hardened fasteners can experience performance problems in wet or corrosive environments. Accordingly, use this product in dry, interior and noncorrosive environments only.

For Technical Data and Loads, see p. 380

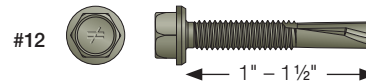

Quik Guard® Coating

Shank Size	Length (in.)	Threads per Inch	Point Size	Washer Dia. (in.)	Drill-Through Thickness (in.)	Carton Quantity	Model No.	Application(s)
10	1	16	3	0.42	0.11 – 0.18	4,000	XQ1B1016-4K	2, 3
12	1	14	3	0.42	0.11 – 0.21	3,500	XQ1B1214-3.5K	2, 3
12	1¼	24	5	0.42	0.13 – 0.5	2,500	XQ114B1224-2.5K	1, 3
12	1½	24	5	0.42	0.13 – 0.5	2,000	XQ112B1224-2K	1, 3



Clear Zinc Coating

Shank Size	Length (in.)	Threads per Inch	Point Size	Drill-Through Thickness (in.)	Carton Quantity	Model No.	Application(s)
10	3/4	16	1	0.03 – 0.11	5,000	XU34B1016-5K	2, 3
10	3/4	16	3	0.11 – 0.18	5,000	X34B1016-5K	2, 3
10	1	16	3	0.11 – 0.18	4,000	X1B1016-4K	2, 3
12	1	14	3	0.11 – 0.21	3,500	X1B1214-3.5K	2, 3

Metal Screws

Self-Drilling E Metal Screw

Common Application:

Cold-formed steel framing

Features:

- Hex-washer head
- Clear zinc finish
- Recommended for use with certain Simpson Strong-Tie® connectors
- #3 drill point (max. total drilling thickness 0.35")
- Bit included in each box (replacement driver bit – BITHEXR38-134)

Codes/Standards: ASTM C1513 compliant

For Technical Data and Loads, see p. 374

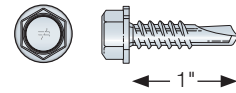

Clear Zinc Coating

Size	Length (in.)	Hex Head Size (in.)	Threads Per Inch	Head Diameter (in.)	Point Size	Carton Quantity	Model No.
#14	1	3/8	14	0.5	#3	100	E1B1414R100
#14	1	3/8	14	0.5	#3	2,500	E1B1414B

Metal Screws

Strong-Drive® TB WOOD-TO-STEEL Screw

Common Applications:

Wood to hot-rolled steel (Maximum recommended thicknesses: 5/16")

Features:

- Flat head with nibs for easy countersinking
- #4 drill point with wings
- #3 square drive (driver bit in each box; replacement bit model BIT3S; use BIT3SU for Mechanically Galvanized – N2000®)
- This screw is also available in collated for the Quik Drive™ system; see p. 274 for details

For Technical Data and Loads, see p. 365

Warning: Industry studies show that hardened fasteners can experience performance problems in wet or corrosive environments. Accordingly, use this product in dry, interior and noncorrosive environments only.



Mechanically Galvanized – N2000®

Length (in.)	Max. Grip Length (in.)	Shank Size	Head Dia. (in.)	Threads per Inch	Carton Quantity	Model No.
2 3/8"	1.65	#12	0.39	14	1,500	TBG1260R1500



Black Phosphate Coating

Length (in.)	Max. Grip Length (in.)	Shank Size	Head Dia. (in.)	Threads per Inch	Carton Quantity	Model No.
1 3/4"	1.06	#12	0.39	14	2,000	TBP1245R2000
1 3/4"	1.06	#12	0.39	14	50	TBP1245R50
2 3/8"	1.65	#14	0.46	14	1,000	TBP1460R1000
2 3/8"	1.65	#14	0.46	14	50	TBP1460R50
3"	2.24	#14	0.46	14	1,000	TBP1475R1000
3"	2.24	#14	0.46	14	50	TBP1475R50

* Grip length includes side member, steel thickness, air gap (if any) and allowance for three threads protruding through the steel.

Metal Screws

Strong-Drive® PPSD SHEATHING-TO-CFS Screw

Wood Sheathing to Cold-Formed Steel

Common Application:

Subfloor/sheathing to cold-formed steel (#8 — maximum thickness: 54 mil/16 ga.; #10 and #12 — maximum thickness: 97 mil/12 ga.)

Features:

- Flat head with nibs for easier countersinking
- #3 square drive (replacement bit BIT3SU-2 for Quik Guard® and BIT3S-2 for yellow zinc coating, see p. 111 for more information)
- Fine threads
- Pilot point
- Head diameter meets AISI lateral design standard
- This screw is also available collated for the Quik Drive® system; see p. 276 for details

Codes/Standards: ASTM C1513 compliant; ICC-ES ESR 3006

For Technical Data and Loads, see p. 371

Warning: Industry studies show that hardened fasteners can experience performance problems in wet or corrosive environments. Accordingly, use this product in dry, interior and noncorrosive environments only.

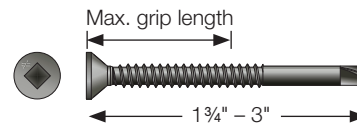

Quik Guard® Coating

Shank Size	Length (in.)	Head Diameter (in.)	Point Size	Thread Length (in.)	Max. Grip Length (in.)	Threads per Inch	Carton Quantity	Model No.
#8	1 15/16	0.32	2	1.22	1.03	18	4,000	PPSDQ11516B-4K
#10	1 3/4	0.33	3	0.98	0.77	16	4,000	PPSDQ134B1016-4K
#12	1 3/4	0.33	3	0.99	0.77	14	4,000	PPSDQ134B1214-4K*
#10	3	0.33	3	1.46	1.25	16	2,000	PPSDQ3B1016-2K
#12	3	0.33	3	1.47	1.25	14	2,000	PPSDQ3B1214-2K*

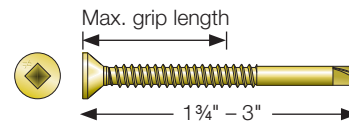

Yellow Zinc Coating

Shank Size	Length (in.)	Head Diameter (in.)	Point Size	Thread Length (in.)	Max. Grip Length (in.)	Threads per Inch	Carton Quantity	Model No.
#8	1 15/16	0.32	2	1.22	1.03	18	4,000	PPSD11516B-4K
#10	1 3/4	0.33	3	0.98	0.77	16	4,000	PPSD134B1016-4K
#12	1 3/4	0.33	3	0.99	0.77	14	4,000	PPSD134B1214-4K*
#10	3	0.33	3	1.46	1.25	16	2,000	PPSD3B1016-2K
#12	3	0.33	3	1.47	1.25	14	2,000	PPSD3B1214-2K*

* Has underhead nibs.

Metal Screws

Strong-Drive® FPHSD FRAMING-TO-CFS Screw

Cold-Formed Steel Framing

Common Application:

Cold-formed steel framing and sheet steel sheathing to cold-formed steel

Features:

- Flat pan head
- Self-drilling
- #3 square drive (driver bit in each box; replacement bit model BIT3S-2)
- This screw is also available collated for the Quik Drive® system; see p. 275 for details

Codes/Standards: ASTM C1513 compliant; ICC-ES ESR 3006

For Technical Data and Loads, see p. 373

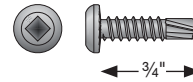

Clear Zinc Coating

Size	Length (in.)	Thread Per Inch	Head Diameter (in.)	Point Size	Approx. Count per lb.	1 lb. Model No.	Bulk	
							Carton Quantity	Model No.
#10	¾	16	0.37	#3	165	FPHSD34B1016	5,000	FPHSD34B1016-5K
#12	¾	14	0.37	#3	147	FPHSD34B1214	5,000	FPHSD34B1214-5K

Metal Screws

Steel Deck Diaphragm Calculator

The Steel Deck Diaphragm Calculator web app offers optimized steel deck design solutions based on fastener and labor costs for a given shear and uplift. It can provide calculations for any solution generated. Generate diaphragm tables for various roof and floor decks using Simpson Strong-Tie® fasteners. The app can also generate a submittal package that includes fastener information, code reports, Factory Mutual reports, Appendix VII and IX of DDM03 (also reference DDM04), coating information and tools for installation. The app is accessible from any web browser and does not require downloading or installing special software. Users can:

- Design for multiple zones and develop solutions in either ASD or LRFD
- Modify deck properties from the standard properties listed in SDI DDM03 and DDM04
- Generate multiple cost- and labor-optimized solutions with calculations included
- Generate tables in Nominal, ASD Wind, LRFD Wind, ASD Seismic or LRFD Seismic
- Design for loads using the new Strong-Drive® XL Large-Head Metal screw (included in the optimization calculator)
- Design for additional structural patterns not covered in SDI literature
- Access proprietary deck tables with the new Strong-Drive® XM Medium-Head Metal screw

Steel Deck Diaphragm Load Tables for Interlocking Decks

Load tables are available on our website application for using Strong-Drive XM Medium-Head Metal screws on frequently used interlocking decks with proprietary side-lap connections.

For more information regarding Strong-Drive XM Medium-Head Metal screw shear tables, refer to strongtie.com/diaphragmcalc.

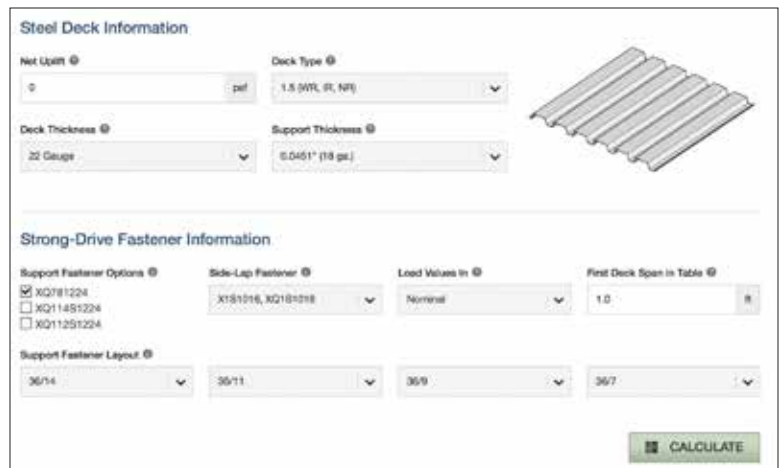
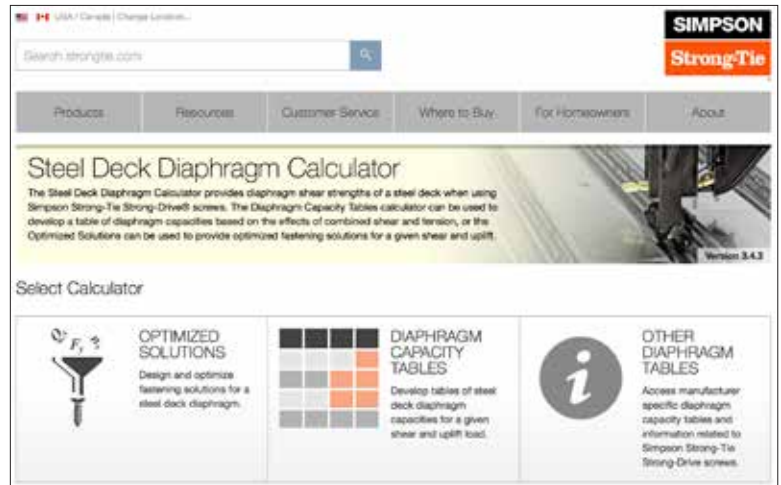

Example of Steel Deck Diaphragm Calculator Web Application

STEEL DECK DIAPHRAGM CALCULATOR

DIAPHRAGM SHEAR STRENGTH TABLES: 0.0451" (18 ga.) SUPPORT STEEL THICKNESS 1.5 (WR, SR, NR) x 22 GAUGE (t = design thickness = 0.0295)

Support Fasteners: XQ211224, XQ11451224, XQ11251224
 Side-Lap Fasteners: X1S1016, XQ1S1018

φ (EQ): 0.85 φ (EQ): 2.50
 φ (Wind): 0.70 φ (Wind): 2.25
 φ (Other): 0.85 φ (Other): 2.50

Click on a shear strength or KI value in the table below to view and print specific calculations.

Support Fastener Layout	Side Lap Fasteners Per Span	Nominal Shear Strength (qf)										KI	
		1.0	1.5	2.0	2.5	3.0	3.5	4.0	4.5	5.0	5.5		6.0
36/14	0	2026	2311	1871	1567	1229	1158	1024	881	794			0.274
	1	3103	2818	3068	2737	1890	1301	1332	1018	912	824	732	0.236
	2	3249	2893	2248	1809	1645	1441	1280	1150	1030	932	850	0.207
	3	3382	2842	2412	2000	1791	1629	1404	1264	1148	1030	948	0.190
	4	3497	2880	2356	2008	1878	1705	1524	1379	1251	1136	1041	0.188
	5	3530	2890	2467	2042	2058	1826	1628	1483	1351	1241	1146	0.181
	6	3600	2180	2026	2466	2181	1945	1750	1587	1449	1332	1232	0.158
	7	3654	2283	2011	2380	2296	2007	1806	1687	1541	1421	1316	0.158
8	3738	2352	2006	2384	2402	2187	1958	1784	1636	1508	1398	0.119	

Example of Steel Deck Diaphragm Load Table for Interlocking Decks

Metal Screws

PCSD Standing-Seam-Roofing Panel Clip Screw

Common Application:

Standing-seam-roofing panel clips to steel, sheet steel sheathing to cold-formed framing

Features:

- Pancake head
- #2 square drive (replacement bit BIT2SU-2 for Quik Guard®; BIT2S-2 for Type 410 stainless steel and clear zinc coating, see p. 111 for more information)
- Drill point
- Type 410 stainless steel is coated for additional corrosion protection
- This screw is also available collated for the Quik Drive® system; see p. 280 for details

Codes/Standards: ASTM C1513 compliant

For Technical Data and Loads, see pp. 375–376

Type 410 Stainless Steel*

Size	Length (in.)	Thread Per Inch	Point Size	Head Diameter (in.)	Carton Quantity	Model No.
#10	1	16	#3	0.41	5,000	SSPCSD1B1016-5K

* These products are subject to quantities on hand or may require special ordering and are subject to minimum order quantities and longer lead times. Call Simpson Strong-Tie for details (800) 999-5099.

Quik Guard® Coating

Size	Length (in.)	Thread Per Inch	Point Size	Head Diameter (in.)	Carton Quantity	Model No.
#10	1	16	#3	0.41	5,000	PCSDQ1B1016-5K
#12	1	14	#3	0.41	4,000	PCSDQ1B1214-4K

Clear Zinc Coating

Size	Length (in.)	Thread Per Inch	Point Size	Head Diameter (in.)	Carton Quantity	Model No.
#10	1	16	#3	0.41	5,000	PCSD1B1016-5K
#12	1	14	#3	0.41	4,000	PCSD1B1214-4K

Self-Drilling Pancake-Head Screw

Common Application:

Ideal for securing clips used in standing-seam-roofing

Features:

- Low-profile head.
- #2 square drive (replacement bit model BIT2S-2; see p. 111 for more information).
- Type 410 stainless steel is coated for additional corrosion protection.
- #2 drill point Type 410 stainless steel can be hardened through heat treatment, giving it the ability to drill through metal. It does not offer the same level of corrosion resistance of either Type 316 or 305 stainless steel.
- **Warning:** Hardened stainless-steel fasteners should not be used with steel framing in environments with high humidity, condensation or other moisture that will be present at the dissimilar-metal interface.

For more information on drilling thickness capacities and drill speed recommendations see pp. 27-28.

Type 410 Stainless Steel*

Size	Length (in.)	Threads Per Inch	Head Diameter (in.)	Carton Quantity	Model No.
#10	1	16	0.41	100	F10T100PSC
#10	1	16	0.41	1,000	F10T100PSM
#10	1	16	0.41	4,500	F10T100PSB

* These products are subject to quantities on hand or may require special ordering and are subject to minimum order quantities and longer lead times. Call Simpson Strong-Tie for details (800) 999-5099.

Metal Screws

Self-Drilling Bugle-Head Screw

Common Application:

Fasten wood, plywood and OSB panels to steel studs

Features:

- Bugle heads drive flush with work surface.
- #2 square drive (replacement bit BIT2S-2).
- Tapping screw threads.
- #3 drill point.
- Type 410 stainless steel is coated for additional corrosion protection.
- Type 410 stainless steel can be hardened through heat treatment, giving it the ability to drill through metal. It does not offer the same level of corrosion resistance of either Type 316 or 305 stainless steel.
- **Warning:** Hardened stainless-steel fasteners should not be used with steel framing in environments with high humidity, condensation or other moisture that will be present at the dissimilar-metal interface.

For more information on drilling thickness capacities and drill speed recommendations see pp. 27-28.

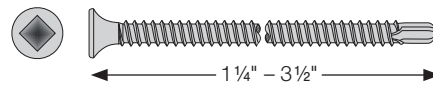

Type 410 Stainless Steel*

Size	Length (in.)	Threads Per Inch	Head Diameter (in.)	Carton Quantity	Model No.
#6	1 ¼	20	0.34	100	F06T125BDC
#6	1 ¼	20	0.34	1,000	F06T125BDM
#6	1 ¼	20	0.34	5,000	F06T125BDB
#8	1 ⅝	18	0.34	100	F08T162BDC
#8	1 ⅝	18	0.34	1,000	F08T162BDM
#8	1 ⅝	18	0.34	3,000	F08T162BDB
#8	2	18	0.34	100	F08T200BDC
#8	2	18	0.34	1,000	F08T200BDM
#8	2	18	0.34	2,500	F08T200BDB
#10	2 ½	16	0.34	100	F10T250BDC
#10	2 ½	16	0.34	1,000	F10T250BDM
#10	2 ½	16	0.34	2,000	F10T250BDB
#10	3	16	0.34	100	F10T300BDC
#10	3	16	0.34	1,500	F10T300BDB
#10	3 ½	16	0.34	100	F10T350BDC
#10	3 ½	16	0.34	1,000	F10T350BDB

* These products are subject to quantities on hand or may require special ordering and are subject to minimum order quantities and longer lead times. Call Simpson Strong-Tie for details (800) 999-5099.

Metal Screws

Self-Drilling Fiber-Cement Screw

Common Application:

Fasten fiber cement through furring strips to steel studs

Features:

- Wafer head, square drive, self-countersinking nibs under the head.
- Threaded to within $\frac{5}{16}$ " of top of head.
- #3 drill point.
- #2 square drive (replacement bit model BIT2S-2; see p. 111 for more information).
- Type 410 stainless steel is coated for additional corrosion protection.
- Type 410 stainless steel can be hardened through heat treatment, giving it the ability to drill through metal. It does not offer the same level of corrosion resistance of either Type 316 or 305 stainless steel.
- **Warning:** Hardened stainless-steel fasteners should not be used with steel framing in environments with high humidity, condensation or other moisture that will be present at the dissimilar-metal interface.

For more information on drilling thickness capacities and drill speed recommendations see pp. 27-28.

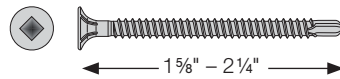

Type 410 Stainless Steel*

Size	Length (in.)	Threads Per Inch	Head Diameter (in.)	Carton Quantity	Model No.
#8	1 $\frac{5}{8}$	18	0.39	100	F08T162WDC
#8	1 $\frac{5}{8}$	18	0.39	1,000	F08T162WDM
#8	1 $\frac{5}{8}$	18	0.39	3,000	F08T162WDB
#8	2 $\frac{1}{4}$	18	0.39	100	F08T225WDC
#8	2 $\frac{1}{4}$	18	0.39	1,000	F08T225WDM
#8	2 $\frac{1}{4}$	18	0.39	2,500	F08T225WDB

* These products are subject to quantities on hand or may require special ordering and are subject to minimum order quantities and longer lead times. Call Simpson Strong-Tie for details (800) 999-5099.

Metal Screws

Self-Drilling Flat-Head Screw with Wings

Common Application:

Fasten wood, plywood and fiber cement to steel — up to 0.209" thick

Features:

- Flat countersunk head with self-countersinking nibs.
- #3 square drive (replacement bit model BIT3S-2; see p. 111 for more information).
- Machine screw thread, threaded full length.
- Shank slot enhances thread formation in steel and removes exhaust.
- Wings above drill point provide clearance hole in work piece so it won't climb up the shank; wings break off as point engages the steel substrate.
- 2½" length for 2x wood; 2" length for 1" and ¾" boards.
- Type 410 stainless steel is coated for additional corrosion protection.
- Type 410 stainless steel can be hardened through heat treatment, giving it the ability to drill through metal. It does not offer the same level of corrosion resistance of either Type 316 or 305 stainless steel.
- **Warning:** Hardened stainless-steel fasteners should not be used with steel framing in environments with high humidity, condensation or other moisture that will be present at the dissimilar-metal interface.

For more information on drilling thickness capacities and drill speed recommendations see pp. 27-28.

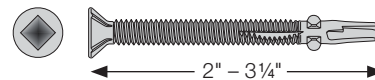

Type 410 Stainless Steel*

Size	Length (in.)	Threads Per Inch	Head Diameter (in.)	Drill Point Size	Carton Quantity	Model No.
#12	2	24	0.38	#3	100	F12C200FDC
#12	2	24	0.38	#3	1,000	F12C200FDM
#12	2	24	0.38	#3	2,500	F12C200FDB
#12	2½	24	0.38	#3	100	F12C250FDC
#12	2½	24	0.38	#3	1,000	F12C250FDM
#12	2½	24	0.38	#3	1,800	F12C250FDB
#14	¾	20	0.47	#4	100	F14C325FDC
#14	¾	20	0.47	#4	1,000	F14C325FDB

* These products are subject to quantities on hand or may require special ordering and are subject to minimum order quantities and longer lead times. Call Simpson Strong-Tie for details (800) 999-5099.

Metal Screws

Self-Drilling Siding Screw

Common Application:

Attach wood siding, wood panels and metal trim to steel studs

Features:

- Trim head.
- Threaded $\frac{2}{3}$ of overall length.
- #3 drill point.
- #1 square drive (replacement bit model BIT1S-2; see p. 111 for more information).
- 1¼" and 1½" models are fully threaded
- 1¼" models are black xylan coated
- Type 410 stainless steel can be hardened through heat treatment, giving it the ability to drill through metal. It does not offer the same level of corrosion resistance of either Type 316 or 305 stainless steel.
- **Warning:** Hardened stainless-steel fasteners should not be used with steel framing in environments with high humidity, condensation or other moisture that will be present at the dissimilar-metal interface.

For more information on drilling thickness capacities and drill speed recommendations see pp. 27-28.

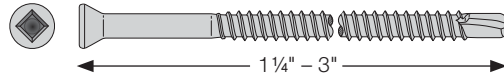

Type 410 Stainless-Steel*

Size	Length (in.)	Threads Per Inch	Head Diameter (in.)	Approx. Count per lb.	Carton Quantity	Model No.
#6	1¼	20	0.23	200	5,000	F06T125TDB
#7	1½	19	0.23	187	100	F07T162TDC
#7	1½	19	0.23	187	1,000	F07T162TDM
#7	1½	19	0.23	187	5,000	F07T162TDB
#7	2¼	19	0.23	132	100	F07T225TDC
#7	2¼	19	0.23	132	1,000	F07T225TDM
#7	2¼	19	0.23	132	4,000	F07T225TDB
#7	3	19	0.23	105	100	F07T300TDC
#7	3	19	0.23	105	1,000	F07T300TDM
#7	3	19	0.23	105	2,000	F07T300TDB

* These products are subject to quantities on hand or may require special ordering and are subject to minimum order quantities and longer lead times. Call Simpson Strong-Tie for details (800) 999-5099.

Metal Screws

Self-Drilling Wafer-Head Screw with Wings

Common Application:

Attach plywood and OSB panels to steel studs

Features:

- #2 Phillips drive.
- Machine-screw thread, threaded full length.
- Wings above drill point provide clearance hole in work piece so it won't climb up the shank; wings break off as point engages the steel substrate.
- #3 drill point.
- Type 410 stainless steel is coated for additional corrosion protection.
- Type 410 stainless steel can be hardened through heat treatment, giving it the ability to drill through metal. It does not offer the same level of corrosion resistance of either Type 316 or 305 stainless steel.
- **Warning:** Hardened stainless-steel fasteners should not be used with steel framing in environments with high humidity, condensation or other moisture that will be present at the dissimilar-metal interface.

For more information on drilling thickness capacities and drill speed recommendations see pp. 27-28.

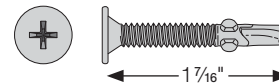

Type 410 Stainless Steel*

Size	Length (in.)	Threads Per Inch	Head Diameter (in.)	Carton Quantity	Model No.
#10	1 7/16	24	0.45	100	F10C144WDC
#10	1 7/16	24	0.45	1,000	F10C144WDM
#10	1 7/16	24	0.45	4,500	F10C144WDB

* These products are subject to quantities on hand or may require special ordering and are subject to minimum order quantities and longer lead times. Call Simpson Strong-Tie for details (800) 999-5099.

Metal Screws

Self-Drilling Wire-Lath Modified Truss-Head Screw

Common Application:

Metal lath to steel studs; corrugated siding panels to steel studs

Features:

- Fasten corrugated siding panels to steel stud without pre-drilling. Securely fastens one to three panel thicknesses.
- #2 Phillips drive.
- #2 drill point for quick penetration of aluminum panels without “point walking.”
- Type 410 stainless steel is coated for additional corrosion protection.
- Type 410 stainless steel can be hardened through heat treatment, giving it the ability to drill through metal. It does not offer the same level of corrosion resistance of either Type 316 or 305 stainless steel.
- **Warning:** Hardened stainless-steel fasteners should not be used with steel framing in environments with high humidity, condensation or other moisture that will be present at the dissimilar-metal interface.

For more information on drilling thickness capacities and drill speed recommendations see pp. 27-28.

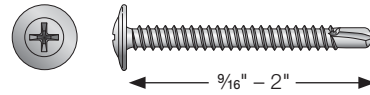

Type 410 Stainless Steel*

Size	Length (in.)	Threads Per Inch	Head Diameter (in.)	Carton Quantity	Model No.
#8	9/16	18	0.42	100	F08T056KDC
#8	9/16	18	0.42	1,000	F08T056KDM
#8	9/16	18	0.42	8,000	F08T056KDB
#8	3/4	18	0.42	100	F08T075KDC
#8	3/4	18	0.42	1,000	F08T075KDM
#8	3/4	18	0.42	6,000	F08T075KDB
#8	1 1/4	18	0.42	100	F08T125KDC
#8	1 1/4	18	0.42	1,000	F08T125KDM
#8	1 1/4	18	0.42	4,000	F08T125KDB
#8	1 5/8	18	0.42	100	F08T162KDC
#8	1 5/8	18	0.42	1,000	F08T162KDM
#8	1 5/8	18	0.42	3,000	F08T162KDB
#8	2	18	0.42	100	F08T200KDC
#8	2	18	0.42	1,000	F08T200KDM
#8	2	18	0.42	2,500	F08T200KDB

* These products are subject to quantities on hand or may require special ordering and are subject to minimum order quantities and longer lead times. Call Simpson Strong-Tie for details (800) 999-5099.

Parts and Accessories

Driver Bits

Our industrial-grade driver bits are specially designed for a secure fit with the recess of Simpson Strong-Tie® fasteners. Available in both square and six-lobe drive configurations, our bits will outperform sub-standard bits commonly prone to cam-out and stripping. **Note:** Undersized bits are designed for use with coated fasteners.

Driver Bits: 6-Lobe

Drive	Bit Length (in.)	Bit Type	Clam Shell Quantity	Model No.
T-15	2	2" power bits	3	BIT15T-2-RC3
T-20	2	2" power bits	3	BIT20T-2-RC3
T-25	2	2" power bits	3	BIT25T-2-RC3
T-27	2	2" power bits	3	BIT27T-2-RC3
T-30	2	2" power bits	3	BIT30T-2-RC3
T-40	1¾	1¾" power bits	3	BIT40T-134-RC3



Driver Bits: Square Drive

Drive	Bit Length (in.)	Bit Type	Clam Shell Quantity	Model No.
#1 SQUARE	2	2" power bits	3	BIT1S-2-RC3
#2 SQUARE	2	2" power bits	3	BIT2S-2-RC3
#2U SQUARE	2	Undersized 2" power bits	3	BIT2SU-2-RC3
#3 SQUARE	2	2" power bits	3	BIT3S-2-RC3
#3U SQUARE	2	Undersized 2" power bits	3	BIT3SU-2-RC3



Driver Bits: Hex Drive

Drive (in.)	Bit Length (in.)	Bit Type	Clam Shell Quantity	Model No.
5/16	1¾	1¾" hex power bit	1	BITHEXR516-134
3/8	1¾	1¾" hex power bit	1	BITHEXR38-134
1/2	1¾	1¾" hex power bit	1	BITHEXR12-134





Cedar and Redwood Decking Nail

**Versatility that
beats the elements.**



Nails

Premium Siding Nail	114
Premium Common Nail	114
Box Nail — Annular Ring Shank	115
Box Nail — Screw-Shank Nail	115
Cedar and Redwood Decking Nail	116
Wood Siding Nail	117
Cedar Trim Nail	117
Common Nail — Annular Ring Shank	118
Common Nail — Smooth Shank	119
Fiber-Cement Siding Nail	120
Finishing Nail	121
Nail with EPDM Washer — Annular Ring Shank	122
Post and Beam Nail — Annular Ring Shank	123
Preservative-Treated Wood Decking Nail	124
Pyramid-Head Nail	125
Painted Siding Nail	126
Shake and Shingle Siding/Roofing Nail	128
Washed Roofing Nail	129
Roofing Nail — Annular Ring Shank	130
Roofing Nail — Smooth Shank	132
Tile/Slating Nail — Annular Ring Shank	133
Tile/Slating Nail — Smooth Shank	134
Custom Nail Worksheet	135

Exterior Nails

Premium Siding Nail

Common Application:

Siding in severe-exposure environments

Features:

- Type 316 stainless steel for seaside applications and severe-exposure environments
- Passivated to remove dirt and swarf ensuring corrosion resistance
- Circle pattern head identifies product as Type 316, reduces glare and accepts surface finishes
- Annular ring shank increases pull-out resistance, provides greater holding power and reduces cupping of siding
- Blunt diamond point drives true and reduces board splitting

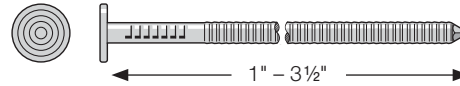

Type 316 Stainless Steel

Penny Size	Length (in.)	Wire Gauge	Shank Diameter (in.)	Head Diameter (in.)	Approx. Count per lb.	1 lb. Model No.	5 lb. Model No.	25 lb. Bucket Model No.	
2d	1	15	0.072	5/32	0.156	807	T2KR51	T2KR55	T2KR5B
2d	1	14	0.083	7/32	0.219	530	T2KR71	T2KR75	T2KR7B
3d	1 1/4	14	0.083	5/32	0.156	495	T3KR51	T3KR55	T3KR5B
3d	1 1/4	14	0.083	7/32	0.219	470	T3KR71	T3KR75	T3KR7B
4d	1 1/2	14	0.083	5/32	0.156	398	T4KR51	T4KR55	T4KR5B
4d	1 1/2	14	0.083	7/32	0.219	394	T4KR71	T4KR75	T4KR7B
5d	1 3/4	14	0.083	5/32	0.156	354	T5KR51	T5KR55	T5KR5B
5d	1 3/4	14	0.083	7/32	0.219	337	T5KR71	T5KR75	T5KR7B
6d	2	14	0.083	5/32	0.156	402	T6KR51	T6KR55	T6KR5B
6d	2	13	0.092	7/32	0.219	261	T6KR71	T6KR75	T6KR7B
7d	2 1/4	13	0.092	5/32	0.156	215	T7KR51	T7KR55	T7KR5B
7d	2 1/4	13	0.092	7/32	0.219	216	T7KR71	T7KR75	T7KR7B
8d	2 1/2	13	0.092	5/32	0.156	196	T8KR51	T8KR55	T8KR5B
8d	2 1/2	13	0.092	7/32	0.219	196	T8KR71	T8KR75	T8KR7B
10d	3	12	0.113	7/32	0.219	120	T10KR71	T10KR75	T10KR7B
12d	3 1/4	12	0.113	7/32	0.219	110	T12KR71	T12KR75	T12KR7B
16d	3 1/2	11	0.120	1/4	0.250	88	T16KR41	T16KR45	T16KR4B

Premium Common Nail

Common Application:

Fastening in severe-exposure environments

Features:

- Type 316 stainless steel for seaside applications and severe-exposure environments
- Passivated to remove dirt and swarf ensuring corrosion resistance
- Circle pattern head identifies product as Type 316, reduces glare and accepts surface finishes
- Annular ring shank increases pull-out resistance, provides greater holding power and reduces cupping of siding
- Blunt diamond point drives true and reduces board splitting

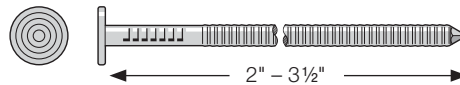

Penny Size	Length (in.)	Wire Gauge	Shank Diameter (in.)	Head Diameter (in.)	Approx. Count per lb.	1 lb. Model No.	5 lb. Model No.	25 lb. Bucket Model No.	
6d	2	11	0.120	1 1/64	0.266	144	T6AKR1	T6AKR5	T6AKRB
8d	2 1/2	10	0.131	9/32	0.281	94	T8AKR1	T8AKR5	T8AKRB
10d	3	9	0.148	5/16	0.312	67	T10AKR1	T10AKR5	T10AKRB
12d	3 1/4	9	0.148	5/16	0.312	60	T12AKR1	T12AKR5	T12AKRB
16d	3 1/2	8	0.162	1 1/32	0.344	44	T16AKR1	T16AKR5	T16AKRB

These products are subject to quantities on hand or may require special ordering and are subject to minimum order quantities and longer lead times. Call Simpson Strong-Tie for details (800) 999-5099.

Exterior Nails

Box Nail — Annular Ring Shank

Features:

- Checker pattern on head blends with wood grain, reduces glare from sunlight and accepts surface finishes
- Annular ring shank increases withdrawal resistance to provide a secure attachment
- Stainless-steel nails are recommended for construction of permanent wood foundations by the *ANSI/AF&PA Permanent Wood Foundations Design Specifications*
- Choose Type 316 stainless steel for seaside applications and superior corrosion resistance
- **Special Order Options** — Call Simpson Strong-Tie for details (800) 999-5099
 - Spiral shank common, post-and-beam and box nails
 - Silicon-bronze nails
 - Painted white nails

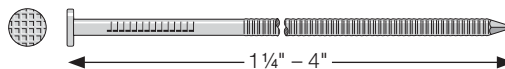

Type 316 Stainless Steel

Penny Size	Length (in.)	Gauge	Shank Diameter (in.)	Head Diameter (in.)	Approx. Count per lb.	1 lb. Model No.	5 lb. Model No.	25 lb. Bucket Model No.
3d	1 1/4	14	0.083	7/32	0.219	473	—	T3ABNB
4d	1 1/2	14	0.083	7/32	0.219	413	T4ABN1	T4ABN5
5d	1 3/4	13	0.092	13/64	0.203	260	T5ABN1	T5ABN5
6d	2	12	0.113	17/64	0.266	175	T6ABN1	T6ABN5
7d	2 1/4	12	0.113	17/64	0.266	153	T7ABN1	T7ABN5
8d	2 1/2	12	0.113	17/64	0.266	138	T8ABN1	T8ABN5
10d	3	11	0.120	17/64	0.266	99	T10ABN1	T10ABN5
12d	3 1/4	10	0.131	9/32	0.281	72	T12ABN1	T12ABN5
16d	3 1/2	10	0.131	9/32	0.281	67	T16ABN1	T16ABN5
20d	4	8	0.162	11/32	0.344	40	—	T20ABNB



Type 304 Stainless Steel

Penny Size	Length (in.)	Gauge	Shank Diameter (in.)	Head Diameter (in.)	Approx. Count per lb.	1 lb. Model No.	5 lb. Model No.	25 lb. Bucket Model No.
3d	1 1/4	14	0.083	7/32	0.219	473	S3ABN1	S3ABN5
4d	1 1/2	14	0.083	7/32	0.219	413	S4ABN1	S4ABN5
5d	1 3/4	13	0.092	13/64	0.203	260	S5ABN1	S5ABN5
6d	2	12	0.113	17/64	0.266	175	S6ABN1	S6ABN5
7d	2 1/4	12	0.113	17/64	0.266	153	S7ABN1	S7ABN5
8d	2 1/2	12	0.113	17/64	0.266	138	S8ABN1	S8ABN5
10d	3	11	0.120	17/64	0.266	99	S10ABN1	S10ABN5
12d	3 1/4	10	0.131	9/32	0.281	72	S12ABN1	S12ABN5
16d	3 1/2	10	0.131	9/32	0.281	67	S16ABN1	S16ABN5
20d	4	8	0.162	11/32	0.344	40	S20ABN1	—

Box Nail — Screw-Shank Nail

Features:

- Checker pattern head blends with wood grain, reduces glare from sunlight and accepts surface finishes
- Screw shank increases withdrawal resistance to provide a secure attachment
- Stainless steel nails are recommended for construction of permanent wood foundations by the *ANSI/AF&PA Permanent Wood Foundations Design Specifications*
- Type 316 stainless steel

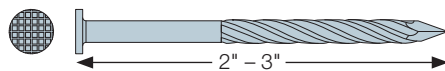

Type 316 Stainless Steel

Penny Size	Length (in.)	Gauge	Shank Diameter (in.)	Head Diameter (in.)	Approx. Count per lb.	1 lb. Model No.	5 lb. Model No.	25 lb. Bucket Model No.
6d	2	12	0.113	17/64	0.266	175	T6SBX1	T6SBX5
8d	2 1/2	12	0.113	17/64	0.266	138	T8SBX1	T8SBX5
10d	3	11	0.12	17/64	0.266	99	T10SPBX1	T10SPBX5

These products are subject to quantities on hand or may require special ordering and are subject to minimum order quantities and longer lead times. Call Simpson Strong-Tie for details (800) 999-5099.

Exterior Nails

Cedar and Redwood Decking Nail

Features:

- Smaller compact heads are less visible
- Checker pattern on head blends with wood grain and reduces glare from sunlight
- Annular ring shank increases pull-out resistance to help prevent nail heads from popping up over time
- Slender shank permits nailing at board ends with reduced splitting
- Diamond point for easier driving
- Available in three colors: Gray, Redwood and Tan
- Choose Type 316 stainless steel for seaside applications and superior corrosion resistance
- Hammer caps recommended for painted-head nails



Type 316 Stainless Steel

Penny Size	Length (in.)	Gauge	Shank Diameter (in.)		Head Diameter (in.)		Color	Approx. Count per lb.	1 lb. Model No.	5 lb. Model No.	25 lb. Bucket Model No.
8d	2½	12	0.113	7/32	0.219	0.219	Non-Painted	145	T8CRD1	T8CRD5	T8CRDB
10d	3	12	0.113	7/32	0.219	0.219	Non-Painted	120	T10CRD1	T10CRD5	T10CRDB
12d	3¼	12	0.113	7/32	0.219	0.219	Non-Painted	110	T12CRD1	T12CRD5	—

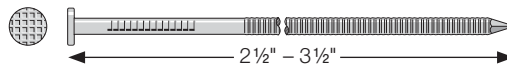

Type 304 Stainless Steel

Penny Size	Length (in.)	Gauge	Shank Diameter (in.)		Head Diameter (in.)		Color	Approx. Count per lb.	1 lb. Model No.	5 lb. Model No.	25 lb. Bucket Model No.
8d	2½	12	0.113	7/32	0.219	0.219	Non-Painted	145	S8CRD1	S8CRD5	S8CRDB
10d	3	12	0.113	7/32	0.219	0.219	Non-Painted	120	S10CRD1	S10CRD5	S10CRDB

These products are subject to quantities on hand or may require special ordering and are subject to minimum order quantities and longer lead times. Call Simpson Strong-Tie for details (800) 999-5099.

Exterior Nails

Wood Siding Nail

Features:

- Checker pattern on head blends with wood grain, reduces glare from sunlight and accepts surface finishes
- Annular ring shank increases pull-out resistance to provide a secure attachment that reduces cupping of siding boards
- Diamond point for easier driving
- Choose Type 316 stainless steel for seaside applications and superior corrosion resistance



Type 316 Stainless Steel

Penny Size	Length (in.)	Gauge	Shank Diameter (in.)	Head Diameter (in.)	Approx. Count per lb.	1 lb. Model No.	5 lb. Model No.	25 lb. Bucket Model No.	
3d	1¼	14	0.083	5/32	0.156	495	T3SND1	T3SND5	T3SNDB
4d	1½	14	0.083	5/32	0.156	398	T4SND1	T4SND5	T4SNDB
5d	1¾	14	0.083	5/32	0.156	354	T5SND1	T5SND5	T5SNDB
6d	2	13	0.092	5/32	0.156	245	T6SND1	T6SND5	T6SNDB
7d	2¼	13	0.092	5/32	0.156	215	T7SND1	T7SND5	T7SNDB
8d	2½	13	0.092	5/32	0.156	196	T8SND1	T8SND5	T8SNDB
10d	3	12	0.113	7/32	0.219	120	T10SND1	T10SND5	T10SNDB
12d	3¼	12	0.113	7/32	0.219	110	T12SND1	T12SND5	T12SNDB
16d	3½	11	0.120	¼	0.250	88	T16SND1	T16SND5	T16SNDB
20d	4	10	0.131	¼	0.250	74	T20SND1	T20SND5	T20SNDB

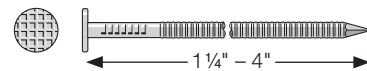

Type 304 Stainless Steel

Penny Size	Length (in.)	Gauge	Shank Diameter (in.)	Head Diameter (in.)	Approx. Count per lb.	1 lb. Model No.	5 lb. Model No.	25 lb. Bucket Model No.	
3d	1¼	14	0.083	5/32	0.156	495	S3SND1	S3SND5	S3SNDB
4d	1½	14	0.083	5/32	0.156	398	S4SND1	S4SND5	S4SNDB
5d	1¾	13	0.092	5/32	0.156	260	SP5SND1	SP5SND5	SP5SNDB
5d	1¾	14	0.083	5/32	0.156	354	S5SND1	S5SND5	S5SNDB
6d	2	13	0.092	5/32	0.156	245	S6SND1	S6SND5	S6SNDB
7d	2¼	13	0.092	5/32	0.156	215	S7SND1	S7SND5	S7SNDB
8d	2½	13	0.092	5/32	0.156	196	S8SND1	S8SND5	S8SNDB
10d	3	12	0.113	7/32	0.219	120	S10SND1	S10SND5	S10SNDB
12d	3¼	12	0.113	7/32	0.219	110	S12SND1	S12SND5	S12SNDB
16d	3½	11	0.120	¼	0.250	88	S16SND1	S16SND5	S16SNDB
20d	4	10	0.131	¼	0.250	74	S20SND1	S20SND5	S20SNDB

Cedar Trim Nail

Features:

- Designed to fashion woven corners
- Ultra-thin 0.072" wire diameter
- Unobtrusive 0.135" diameter head
- Blunt diamond point minimizes shingle splitting
- Annular ring-shank thread
- Choose Type 316 stainless steel for seaside applications and superior corrosion resistance

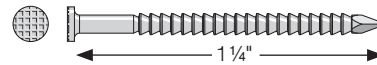

Type 316 Stainless Steel

Penny Size	Length (in.)	Wire Gauge	Shank Diameter (in.)	Head Diameter (in.)	Approx. Count per lb.	1 lb. Model No.	5 lb. Model No.	
3d	1¼	15	0.072	5/64	0.141	550	T3ACDRWVR1	T3ACDRWVR5



Type 304 Stainless Steel

Penny Size	Length (in.)	Wire Gauge	Shank Diameter (in.)	Head Diameter (in.)	Approx. Count per lb.	1 lb. Model No.	5 lb. Model No.	25 lb. Model No.	
3d	1¼	15	0.072	5/64	0.141	550	S3ACDRWVR1	S3ACDRWVR5	—
5d	1¾	15	0.072	5/64	0.141	550	—	—	S5ACDRWVRB

These products are subject to quantities on hand or may require special ordering and are subject to minimum order quantities and longer lead times. Call Simpson Strong-Tie for details (800) 999-5099.

Exterior Nails

Common Nail — Annular Ring Shank

Features:

- Annular ring shank increases withdrawal resistance to provide a secure attachment
- Stainless-steel nails are recommended for construction of permanent wood foundations by the *ANSI/AF&PA Permanent Wood Foundations Design Specifications*
- Choose Type 316 stainless steel for seaside applications and superior corrosion resistance
- **Special Order Options** — Call Simpson Strong-Tie for details (800) 999-5099
 - Spiral shank
 - Silicon-bronze nails



Type 316 Stainless Steel

Penny Size	Length (in.)	Gauge	Shank Diameter (in.)	Head Diameter (in.)	Approx. Count per lb.	1 lb. Model No.	5 lb. Model No.	25 lb. Bucket Model No.	
2d	1	15	0.072	3/16	0.188	807	T2ACN1	T2ACN5	T2ACNB
3d	1 1/4	14	0.083	7/32	0.219	473	T3ACN1	T3ACN5	T3ACNB
4d	1 1/2	12	0.113	1/4	0.250	228	T4ACN1	T4ACN5	T4ACNB
4d	1 1/2	9	0.148	5/16	0.313	130	T4HACN1	T4HACN5	T4HACNB
5d	1 3/4	12	0.113	1/4	0.250	193	T5ACN1	—	T5ACNB
6d	2	11	0.120	17/64	0.266	144	T6ACN1	T6ACN5	T6ACNB
7d	2 1/4	11	0.120	17/64	0.266	133	—	—	T7ACNB
8d	2 1/2	10	0.131	9/32	0.281	94	T8ACN1	T8ACN5	T8ACNB
10d	3	9	0.148	5/16	0.313	67	T10ACN1	T10ACN5	T10ACNB
12d	3 1/4	9	0.148	5/16	0.313	60	T12ACN1	T12ACN5	T12ACNB
16d	3 1/2	8	0.162	11/32	0.344	44	T16ACN1	T16ACN5	T16ACNB
20d	4	6	0.203	7/16	0.438	25	T20ACN1	T20ACN5	T20ACNB
30d	4 1/2	6	0.203	7/16	0.438	22	—	T30ACN5	T30ACNB
40d	5	6	0.203	7/16	0.438	19	T40ACN1	T40ACN5	T40ACNB
60d	6	4	0.238	15/32	0.469	12	T60ACN1	T60ACN5	T60ACNB
70d	7	4	0.238	15/32	0.469	10	T70ACN1	—	T70ACNB

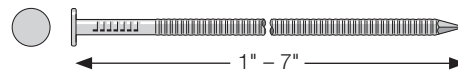

Type 304 Stainless Steel

Penny Size	Length (in.)	Gauge	Shank Diameter (in.)	Head Diameter (in.)	Approx. Count per lb.	1 lb. Model No.	5 lb. Model No.	25 lb. Bucket Model No.	
2d	1	15	0.072	3/16	0.188	807	S2ACN1	S2ACN5	S2ACNB
2d	1	14	0.083	7/32	0.219	530	S2HACN1	S2HACN5	S2HACNB
3d	1 1/4	14	0.083	7/32	0.219	473	S3ACN1	S3ACN5	S3ACNB
4d	1 1/2	12	0.113	1/4	0.250	228	S4ACN1	S4ACN5	S4ACNB
5d	1 3/4	12	0.113	1/4	0.250	193	S5ACN1	S5ACN5	S5ACNB
6d	2	11	0.120	17/64	0.266	144	S6ACN1	S6ACN5	S6ACNB
7d	2 1/4	11	0.120	17/64	0.266	133	S7ACN1	S7ACN5	S7ACNB
8d	2 1/2	10	0.131	9/32	0.281	94	S8ACN1	S8ACN5	S8ACNB
10d	3	9	0.148	5/16	0.313	67	S10ACN1	S10ACN5	S10ACNB
12d	3 1/4	9	0.148	5/16	0.313	60	S12ACN1	S12ACN5	S12ACNB
16d	3 1/2	8	0.162	11/32	0.344	44	S16ACN1	S16ACN5	S16ACNB
20d	4	6	0.203	7/16	0.438	25	S20ACN1	S20ACN5	S20ACNB
30d	4 1/2	6	0.203	7/16	0.438	22	S30ACN1	S30ACN5	S30ACNB
40d	5	6	0.203	7/16	0.438	19	S40ACN1	S40ACN5	S40ACNB
60d	6	4	0.238	15/32	0.469	12	S60ACN1	S60ACN5	S60ACNB
70d	7	4	0.238	15/32	0.469	10	S70ACN1	—	S70ACNB

These products are subject to quantities on hand or may require special ordering and are subject to minimum order quantities and longer lead times. Call Simpson Strong-Tie for details (800) 999-5099.

Exterior Nails

Common Nail — Smooth Shank

Features:

- Stainless-steel nails are recommended for construction of permanent wood foundations by the *ANSI/AF&PA Permanent Wood Foundations Design Specifications*
- Choose Type 316 stainless steel for seaside applications and superior corrosion resistance
- Special Order Options** — Call Simpson Strong-Tie for details (800) 999-5099
 - Spiral shank
 - Silicon-bronze nails

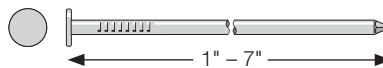

Type 316 Stainless Steel

Penny Size	Length (in.)	Gauge	Shank Diameter (in.)	Head Diameter (in.)	Approx. Count per lb.	1 lb. Model No.	5 lb. Model No.	25 lb. Bucket Model No.	
2d	1	15	0.072	3/16	0.188	807	T2CN1	—	T2CNB
3d	1 1/4	14	0.083	7/32	0.219	473	T3CN1	—	T3CNB
4d	1 1/2	12	0.113	1/4	0.250	228	T4CN1	T4CN5	T4CNB
5d	1 3/4	12	0.113	1/4	0.250	193	—	—	T5CNB
6d	2	11	0.120	17/64	0.266	144	T6CN1	—	T6CNB
7d	2 1/4	11	0.120	17/64	0.266	133	T7CN1	—	—
8d	2 1/2	10	0.131	9/32	0.281	94	T8CN1	T8CN5	T8CNB
10d	3	9	0.148	5/16	0.313	67	T10CN1	T10CN5	T10CNB
12d	3 1/4	9	0.148	5/16	0.313	60	T12CN1	—	—
16d	3 1/2	8	0.162	11/32	0.344	44	T16CN1	T16CN5	T16CNB
20d	4	6	0.203	7/16	0.438	25	T20CN1	T20CN5	T20CNB
30d	4 1/2	6	0.203	7/16	0.438	22	—	—	T30CNB
40d	5	6	0.203	7/16	0.438	19	—	T40CN5	T40CNB
60d	6	4	0.238	15/32	0.469	12	T60CN1	T60CN5	T60CNB
70d	7	4	0.238	15/32	0.469	10	—	—	—

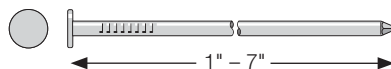

Type 304 Stainless Steel

Penny Size	Length (in.)	Gauge	Shank Diameter (in.)	Head Diameter (in.)	Approx. Count per lb.	1 lb. Model No.	5 lb. Model No.	25 lb. Bucket Model No.	
2d	1	15	0.072	3/16	0.188	807	S2CN1	S2CN5	S2CNB
3d	1 1/4	14	0.083	7/32	0.219	473	S3CN1	S3CN5	S3CNB
4d	1 1/2	12	0.113	1/4	0.250	228	S4CN1	S4CN5	S4CNB
4d	1 1/2	9	0.148	5/16	0.313	130	S4HCN1	S4HCN5	S4HCNB
5d	1 3/4	12	0.113	1/4	0.250	193	—	—	S5CNB
6d	2	11	0.120	17/64	0.266	144	S6CN1	S6CN5	S6CNB
8d	2 1/2	10	0.131	9/32	0.281	94	S8CN1	S8CN5	S8CNB
10d	3	9	0.148	5/16	0.313	67	S10CN1	S10CN5	S10CNB
12d	3 1/4	9	0.148	5/16	0.313	60	S12CN1	—	S12CNB
16d	3 1/2	8	0.162	11/32	0.344	44	S16CN1	S16CN5	S16CNB
20d	4	6	0.203	7/16	0.438	25	S20CN1	S20CN5	S20CNB
30d	4 1/2	6	0.203	7/16	0.438	22	—	—	—
40d	5	6	0.203	7/16	0.438	19	S40CN1	S40CN5	S40CNB
60d	6	4	0.238	15/32	0.469	12	S60CN1	S60CN5	S60CNB

These products are subject to quantities on hand or may require special ordering and are subject to minimum order quantities and longer lead times. Call Simpson Strong-Tie for details (800) 999-5099.

Exterior Nails

Fiber-Cement Siding Nail

Features:

- Designed expressly for application of various lap and panel siding materials made of fiber-cement composites
- Checker pattern on head blends with faux wood grain, reduces glare from sunlight and accepts surface finishes
- Annular ring shank increases withdrawal resistance to provide a secure attachment
- 1 ¼" length has an 1/32" head for blind-nailing lap siding
- Diamond point for easier driving
- Recommended for seaside applications and superior corrosion resistance

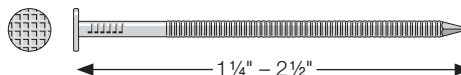

Type 316 Stainless Steel

Penny Size	Length (in.)	Gauge	Shank Diameter (in.)	Head Diameter (in.)		Approx. Count per lb.	1 lb. Model No.	5 lb. Model No.	25 lb. Bucket Model No.
3d	1 ¼	11	0.120	1 1/32	0.344	199	T3PCS1	T3PCS5	T3PCSB
4d	1 ½	11	0.120	9/32	0.281	179	T4PCS1	T4PCS5	T4PCSB
6d	2	11	0.120	9/32	0.281	144	T6PCS1	T6PCS5	T6PCSB
8d	2 ½	11	0.120	9/32	0.281	115	T8PCS1	T8PCS5	T8PCSB

These products are subject to quantities on hand or may require special ordering and are subject to minimum order quantities and longer lead times. Call Simpson Strong-Tie for details (800) 999-5099.

Exterior Nails

Finishing Nail

Features:

- Brad head for a less-visible appearance
- Smooth shank, diamond point for easier driving
- Choose Type 316 stainless steel for seaside applications and superior corrosion resistance

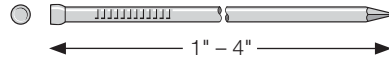

Type 316 Stainless Steel

Penny Size	Length (in.)	Gauge	Shank Diameter (in.)	Head Diameter (in.)	Approx. Count per lb.	1 lb. Model No.	5 lb. Model No.	25 lb. Bucket Model No.	
2d	1	15	0.072	$\frac{6}{55}$	0.109	863	T2FN1*	—	T2FNB*
3d	1¼	15	0.072	$\frac{6}{55}$	0.109	649	T3FN1*	T3FN5*	T3FNB*
4d	1½	14	0.083	$\frac{3}{25}$	0.120	434	T4FN1	T4FN5	T4FNB
5d	1¾	14	0.083	$\frac{3}{25}$	0.120	375	T5FN1*	—	T5FNB*
6d	2	13	0.092	$\frac{5}{37}$	0.135	247	T6FN1	T6FN5	T6FNB
8d	2½	12	0.113	$\frac{4}{27}$	0.148	146	T8FN1	T8FN5	T8FNB
10d	3	11	0.120	$\frac{16}{97}$	0.165	102	T10FN1	T10FN5	T10FNB
12d	3¼	11	0.120	$\frac{16}{97}$	0.165	97	T12FN1*	T12FN5*	T12FNB*
16d	3½	11	0.120	$\frac{16}{97}$	0.165	86	T16FN1	T16FN5	T16FNB
20d	4	11	0.120	$\frac{1}{5}$	0.201	85	T20FN1*	T20FN5*	T20FNB*

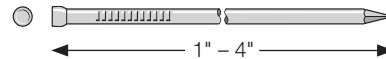

Type 304 Stainless Steel

Penny Size	Length (in.)	Gauge	Shank Diameter (in.)	Head Diameter (in.)	Approx. Count per lb.	1 lb. Model No.	5 lb. Model No.	25 lb. Bucket Model No.	
2d	1	15	0.072	$\frac{6}{55}$	0.109	863	S2FN1*	—	S2FNB*
3d	1¼	15	0.072	$\frac{6}{55}$	0.109	649	S3FN1*	S3FN5*	S3FNB*
4d	1½	14	0.083	$\frac{3}{25}$	0.120	434	S4FN1	S4FN5	S4FNB
5d	1¾	14	0.083	$\frac{3}{25}$	0.120	375	S5FN1*	S5FN5*	S5FNB*
6d	2	13	0.092	$\frac{5}{37}$	0.135	247	S6FN1	S6FN5	S6FNB
8d	2½	12	0.113	$\frac{4}{27}$	0.148	146	S8FN1	S8FN5	S8FNB
10d	3	11	0.120	$\frac{16}{97}$	0.165	102	S10FN1	S10FN5	S10FNB
12d	3¼	11	0.120	$\frac{16}{97}$	0.165	97	S12FN1*	S12FN5*	S12FNB*
16d	3½	11	0.120	$\frac{16}{97}$	0.165	86	S16FN1	S16FN5	S16FNB
20d	4	11	0.120	$\frac{1}{5}$	0.201	85	S20FN1*	S20FN5*	S20FNB*

Exterior Nails

Nail with EPDM Washer — Annular Ring Shank

Features:

- Smooth head
- Washers are made from Types 316 and 304 stainless steel with bonded EPDM washer to provide a weather-resistant seal for exterior sheathing and roofing applications
- Annular ring shanks increase withdrawal resistance to provide a secure attachment
- For information on purchasing washers separately see p. 135

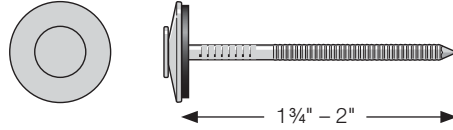

Type 316 Stainless Steel

Penny Size	Length (in.)	Gauge	Shank Diameter (in.)	Washer Diameter (in.)	Model No.	
					100 count	1,000 count
5d	1 3/4	10	0.131	0.625	T10A175X0C	—
6d	2	10	0.131	0.625	—	T10A200X07

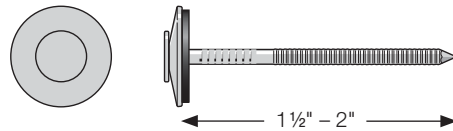

Type 304 Stainless Steel

Penny Size	Length (in.)	Gauge	Shank Diameter (in.)	Washer Diameter (in.)	Model No.	
					100 count	1,000 count
4d	1 1/2	10	0.131	0.625	—	S10A150X0M
5d	1 3/4	10	0.131	0.625	—	S10A175X0M

These products are subject to quantities on hand or may require special ordering and are subject to minimum order quantities and longer lead times. Call Simpson Strong-Tie for details (800) 999-5099.

Exterior Nails

Post and Beam Nail — Annular Ring Shank

Features:

- Checker pattern on head blends with wood grain, reduces glare from sunlight and accepts surface finishes
- Annular ring shank increases withdrawal resistance to provide a secure attachment
- Stainless-steel nails are recommended for construction of permanent wood foundations by the *ANSI/AF&PA Permanent Wood Foundations Design Specifications*
- Choose Type 316 stainless steel for seaside applications and superior corrosion resistance
- **Special Order Options** — Call Simpson Strong-Tie for details (800) 999-5099
 - Spiral shank
 - Silicon-bronze nails

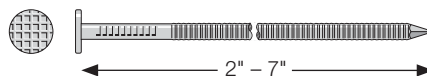

Type 316 Stainless Steel

Penny Size	Length (in.)	Gauge	Shank Diameter (in.)	Head Diameter (in.)		Approx. Count per lb.	1 lb. Model No.	5 lb. Model No.	25 lb. Bucket Model No.
8d	2½	11	0.120	17/64	0.266	115	—	—	T8APBB
60d	6	6	0.203	7/16	0.438	17	—	—	T60APBB

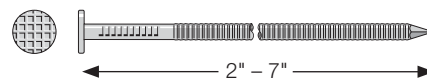

Type 304 Stainless Steel

Penny Size	Length (in.)	Gauge	Shank Diameter (in.)	Head Diameter (in.)		Approx. Count per lb.	1 lb. Model No.	5 lb. Model No.	25 lb. Bucket Model No.
8d	2½	11	0.120	17/64	0.266	115	S8APB1	S8APB5	—
10d	3	10	0.131	9/32	0.281	79	—	S10APB5	S10APBB
16d	3½	9	0.148	5/16	0.313	56	—	—	S16APBB
20d	4	8	0.162	11/32	0.344	40	—	—	S20APBB
30d	4½	8	0.162	11/32	0.344	35	—	S30APB5	S30APBB
40d	5	8	0.162	11/32	0.344	31	—	—	S40APBB
60d	6	6	0.203	7/16	0.438	17	—	—	S60APBB

Exterior Nails

Preservative-Treated Wood Decking Nail

Features:

- Ideal for decks and docks
- Checker pattern on head blends with wood grain and reduces glare from sunlight
- Annular ring shank increases withdrawal resistance to help prevent nail heads from popping up over time
- Larger shank diameter easily penetrates both green and seasoned preservative-treated pine
- Diamond point for easier driving
- Choose Type 316 stainless steel for seaside applications and superior corrosion resistance

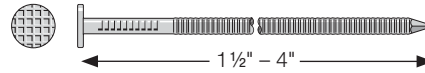

Type 316 Stainless Steel

Penny Size	Length (in.)	Gauge	Shank Diameter (in.)	Head Diameter (in.)	Approx Count per lb.	1 lb. Model No.	5 lb. Model No.	25 lb. Bucket Model No.	
4d	1½	12	0.113	¼	0.250	228	T4PTD1	T4PTD5	T4PTDB
6d	2	11	0.120	⅜	0.281	144	T6PTD1	T6PTD5	T6PTDB
8d	2½	11	0.120	⅜	0.281	115	T8PTD1	T8PTD5	T8PTDB
8d	2½	10	0.131	⅜	0.281	94	T8HPTD1	T8HPTD5	T8HPTDB
10d	3	10	0.131	⅜	0.281	79	T10PTD1	T10PTD5	T10PTDB
10d	3	9	0.148	⅝	0.313	67	T10HPTD1	T10HPTD5	T10HPTDB
12d	3¼	9	0.148	⅝	0.313	60	T12PTD1	T12PTD5	T12PTDB
16d	3½	9	0.148	⅝	0.313	56	T16PTD1	T16PTD5	T16PTDB
16d	3½	8	0.162	⅞	0.344	44	T16HPTD1	T16HPTD5	T16HPTDB
20d	4	8	0.162	⅞	0.344	40	T20PTD1	T20PTD5	T20PTDB
20d	4	6	0.203	7⁄16	0.438	25	—	T20HPTD5	T20HPTDB

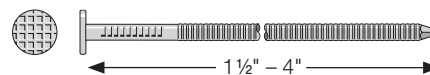

Type 304 Stainless Steel

Penny Size	Length (in.)	Gauge	Shank Diameter (in.)	Head Diameter (in.)	Approx Count per lb.	1 lb. Model No.	5 lb. Model No.	25 lb. Bucket Model No.	
4d	1½	12	0.113	¼	0.250	228	S4PTD1	S4PTD5	S4PTDB
6d	2	11	0.120	⅜	0.281	144	S6PTD1	S6PTD5	S6PTDB
8d	2½	11	0.120	⅜	0.281	115	S8PTD1	S8PTD5	S8PTDB
8d	2½	10	0.131	⅜	0.281	94	S8HPTD1	S8HPTD5	S8HPTDB
10d	3	10	0.131	⅜	0.281	79	S10PTD1	S10PTD5	S10PTDB
10d	3	9	0.148	⅝	0.313	67	S10HPTD1	S10HPTD5	S10HPTDB
12d	3¼	9	0.148	⅝	0.313	60	S12PTD1	S12PTD5	S12PTDB
16d	3½	9	0.148	⅝	0.313	56	S16PTD1	S16PTD5	S16PTDB
16d	3½	8	0.162	⅞	0.344	44	S16HPTD1	S16HPTD5	S16HPTDB
20d	4	8	0.162	⅞	0.344	40	S20PTD1	S20PTD5	S20PTDB
20d	4	6	0.203	7⁄16	0.438	25	S20HPTD1	S20HPTD5	S20HPTDB

These products are subject to quantities on hand or may require special ordering and are subject to minimum order quantities and longer lead times. Call Simpson Strong-Tie for details (800) 999-5099.

Exterior Nails

Pyramid-Head Nail

Features:

- “Pyramid” style decorative heads are reminiscent of old rose-head nails and lend a rustic look to face-nailed lap, bevel and board and batten siding jobs
- Annular ring shank increases withdrawal resistance to provide a secure attachment
- Silicon bronze weathers to dark brown color

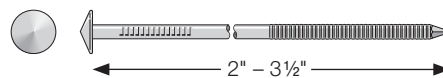

Type 316 Stainless Steel

Penny Size	Length (in.)	Gauge	Shank Diameter (in.)	Head Diameter (in.)		Approx. Count per lb.	1 lb. Model No.	5 lb. Model No.	25 lb. Bucket Model No.
6d	2	11	0.120	¼	0.250	144	—	—	T6PSNB
8d	2½	11	0.120	¼	0.250	115	—	—	T8PSNB

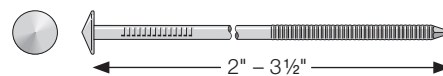

Silicon Bronze

Penny Size	Length (in.)	Gauge	Shank Diameter (in.)	Head Diameter (in.)		Approx. Count per lb.	1 lb. Model No.	5 lb. Model No.	25 lb. Bucket Model No.
6d	2	11	0.120	¼	0.250	144	—	—	I6PSNB
8d	2½	11	0.120	¼	0.250	115	—	—	I8PSNB
16d	3½	11	0.120	¼	0.250	88	—	—	I16PSNB

Bevel Siding Installation Calculator

Nominal Width	Exposed Face (in.)	Overlap (in.)	Nail Count Factor Linear Foot	Nail Count Factor Square Foot
4	2½	1	0.75	3.60
6	4½	1	0.75	2.03
8	6½	1½	0.75	1.43
10	8½	1½	0.75	1.13
12	10½	1½	0.75	0.90

How To Figure:

Multiply the linear feet or square feet by the nail count factor. The result is the quantity of nails required.

- One (1) nail per stud – 16" on center
- Allowance for waste and loss should be added

Exterior Nails

Painted Siding Nail

Features:

- Premium-quality nails for cedar, redwood and cypress siding materials
- Durable painted finish helps heads blend with siding material
- Checker pattern on head blends with wood texture
- Annular ring shank increases withdrawal resistance to provide a secure attachment that reduces cupping of siding boards
- Slender gauge and diamond point for easier driving
- Custom colors available upon request (minimums apply) – call for details
- Choose Type 316 stainless steel for seaside applications and superior corrosion resistance
- Hammer caps recommended for painted head nails

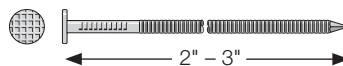

Type 316 Stainless Steel

Penny Size	Length (in.)	Gauge	Shank Diameter (in.)	Head Diameter (in.)		Color	Approx. Count per lb.	1 lb. Model No.	5 lb. Model No.	25 lb. Bucket Model No.
6d	2	13	0.092	5/32	0.156	Gray	245	—	—	T6SNDGB
6d	2	13	0.092	5/32	0.156	Redwood	245	—	T6SNDR5	T6SNDRB
6d	2	13	0.092	5/32	0.156	White	245	—	—	T6SNDWB
8d	2½	13	0.092	5/32	0.156	Dark Brown	196	—	—	T8SNDDB
8d	2½	13	0.092	5/32	0.156	White	196	T8SNDW1	T8SNDW5	T8SNDWB
10d	3	12	0.113	7/32	0.219	Dark Brown	120	—	—	T10SNDDB
10d	3	12	0.113	7/32	0.219	Gray	120	—	—	—
10d	3	12	0.113	7/32	0.219	Redwood	120	—	—	—
10d	3	12	0.113	7/32	0.219	Tan	120	—	—	—
10d	3	12	0.113	7/32	0.219	White	120	T10SNDW1	T10SNDW5	—



These products are subject to quantities on hand or may require special ordering and are subject to minimum order quantities and longer lead times. Call Simpson Strong-Tie for details (800) 999-5099.

Exterior Nails

Painted Siding Nail (cont.)

Type 304 Stainless Steel



Penny Size	Length (in.)	Gauge	Shank Diameter (in.)	Head Diameter (in.)	Color	Approx. Count per lb.	1 lb. Model No.	5 lb. Model No.	25 lb. Bucket Model No.
4d	1½	14	0.083	5/32	Redwood	398	S4SNDR1	S4SNDR5	—
4d	1½	14	0.083	5/32	Tan	398	S4SNDT1	S4SNDT5	—
4d	1½	14	0.083	5/32	White	398	—	—	S4SNDWB
6d	2	13	0.092	5/32	Dark Brown	245	S6SNDB1	S6SNDB5	S6SNDBB
6d	2	13	0.092	5/32	Gray	245	S6SNDG1	S6SNDG5	S6SNDGB
6d	2	13	0.092	5/32	Redwood	245	S6SNDR1	S6SNDR5	S6SNDRB
6d	2	13	0.092	5/32	Sienna	245	S6SNDS1	S6SNDS5	S6SNDSB
6d	2	13	0.092	5/32	Tan	245	S6SNDT1	S6SNDT5	S6SNDTB
6d	2	13	0.092	5/32	White	245	S6SNDW1	S6SNDW5	S6SNDWB
8d	2½	13	0.092	5/32	Dark Brown	196	S8SNDB1	S8SNDB5	S8SNDBB
8d	2½	13	0.092	5/32	Gray	196	S8SNDG1	S8SNDG5	S8SNDGB
8d	2½	13	0.092	5/32	Redwood	196	S8SNDR1	S8SNDR5	S8SNDRB
8d	2½	13	0.092	5/32	Sienna	196	S8SNDS1	S8SNDS5	S8SNDSB
8d	2½	13	0.092	5/32	Tan	196	S8SNDT1	S8SNDT5	S8SNDTB
8d	2½	13	0.092	5/32	White	196	S8SNDW1	S8SNDW5	S8SNDWB
10d	3	12	0.113	7/32	Dark Brown	120	S10SNDB1	S10SNDB5	S10SNDBB
10d	3	12	0.113	7/32	Gray	120	S10SNDG1	S10SNDG5	S10SNDGB
10d	3	12	0.113	7/32	Redwood	120	S10SNDR1	S10SNDR5	S10SNDRB
10d	3	12	0.113	7/32	Tan	120	S10SNDT1	S10SNDT5	S10SNDTB
10d	3	12	0.113	7/32	White	120	S10SNDW1	S10SNDW5	S10SNDWB
16d	3½	11	0.120	¼	Dark Brown	88	S16SNDB1	S16SNDB5	S16SNDBB
16d	3½	11	0.120	¼	Gray	88	S16SNDG1	S16SNDG5	S16SNDGB
16d	3½	11	0.120	¼	Redwood	88	S16SNDR1	S16SNDR5	S16SNDRB
16d	3½	11	0.120	¼	Sienna	88	S16SNDS1	S16SNDS5	S16SNDSB
16d	3½	11	0.120	¼	Tan	88	S16SNDT1	S16SNDT5	S16SNDTB



Exterior Nails

Shake and Shingle Siding/Roofing Nail

Features:

- $\frac{7}{32}$ " diameter flat head provides ample bearing surface to firmly secure shakes and shingles of all types
- Checker pattern on head blends with wood grain, reduces glare from sunlight and accepts surface finishes
- Annular ring-shank increases withdrawal resistance to provide a secure attachment that helps reduce cupping of siding boards
- Slender shanks minimize splitting
- Diamond point for easier driving
- Choose Type 316 stainless steel for seaside applications and superior corrosion resistance

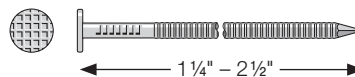

Type 316 Stainless Steel

Penny Size	Length (in.)	Gauge	Shank Diameter (in.)	Head Diameter (in.)	Approx. Count per lb.	1 lb. Model No.	5 lb. Model No.	25 lb. Bucket Model No.
3d	1 ¼	14	0.083	$\frac{7}{32}$	470	T3SN71	T3SN75	T3SN7B
4d	1 ½	14	0.083	$\frac{7}{32}$	394	T4SN71	T4SN75	T4SN7B
5d	1 ¾	14	0.083	$\frac{7}{32}$	337	T5SN71	T5SN75	T5SN7B
6d	2	13	0.092	$\frac{7}{32}$	237	T6SN71	T6SN75	T6SN7B
7d	2 ¼	13	0.092	$\frac{7}{32}$	216	T7SN71	T7SN75	T7SN7B
8d	2 ½	13	0.092	$\frac{7}{32}$	196	T8SN71	T8SN75	T8SN7B

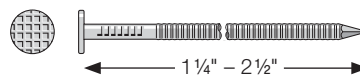

Type 304 Stainless Steel

Penny Size	Length (in.)	Gauge	Shank Diameter (in.)	Head Diameter (in.)	Approx. Count per lb.	1 lb. Model No.	5 lb. Model No.	25 lb. Bucket Model No.
3d	1 ¼	14	0.083	$\frac{7}{32}$	470	S3SN71	S3SN75	S3SN7B
4d	1 ½	14	0.083	$\frac{7}{32}$	394	S4SN71	S4SN75	S4SN7B
5d	1 ¾	14	0.083	$\frac{7}{32}$	337	S5SN71	S5SN75	S5SN7B
6d	2	13	0.092	$\frac{7}{32}$	237	S6SN71	S6SN75	S6SN7B
7d	2 ¼	13	0.092	$\frac{7}{32}$	216	S7SN71	S7SN75	S7SN7B
8d	2 ½	13	0.092	$\frac{7}{32}$	196	S8SN71	S8SN75	S8SN7B

These products are subject to quantities on hand or may require special ordering and are subject to minimum order quantities and longer lead times. Call Simpson Strong-Tie for details (800) 999-5099.

Exterior Nails

Washed Roofing Nail

Features:

- Heavy EPDM washer provides a weather-proof seal ($\frac{9}{16}$ " O.D. x $\frac{1}{8}$ " thick)
- Recommended fastener for installation of corrugated-panel roofing as well as sheet-metal roofing and siding in corrosive environments
- Annular ring shank increases withdrawal resistance to provide a secure attachment to wood members

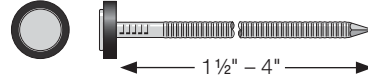

Type 304 Stainless Steel

Penny Size	Length (in.)	Gauge	Shank Diameter (in.)	Head Diameter (in.)		Approx. Count per lb.	5 lb. Model No.	25 lb. Bucket Model No.
4d	1½	10	0.131	¾	0.375	113	S10150RNW5	S10150RNWB
5d	1¾	10	0.131	¾	0.375	105	S10175RNW5	S10175RNWB
6d	2	10	0.131	¾	0.375	98	S10200RNW5	S10200RNWB
8d	2½	10	0.131	¾	0.375	83	S10250RNW5	S10250RNWB
10d	3	10	0.131	¾	0.375	72	S10300RNW5	S10300RNWB

Exterior Nails

Roofing Nail — Annular Ring Shank

Features:

- Large, flat head provides extra bearing surface to firmly secure roofing material
- Annular ring shank increases withdrawal resistance to provide a secure attachment to wood members and plywood roof decks
- Longer lengths ideal for installing curved Spanish roof tiles and thicker slate
- Aluminum nails also available with a screw shank; call Simpson Strong-Tie for details (800) 999-5099

Installation Tips:

- For slate roofs, determine the correct nail length by doubling the slate thickness and adding one inch

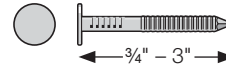

Type 316 Stainless Steel

Penny Size	Length (in.)	Gauge	Shank Diameter (in.)	Head Diameter (in.)	Approx. Count per lb.	1 lb. Model No.	5 lb. Model No.	25 lb. Bucket Model No.	
—	3/4	10	0.131	3/8	0.375	281	T7510ARN1	T7510ARN5	T7510ARNB
2d	1	10	0.131	3/8	0.375	212	T210ARN1	T210ARN5	T210ARNB
3d	1 1/4	10	0.131	3/8	0.375	166	T310ARN1	T310ARN5	T310ARNB
3d	1 1/4	11	0.120	1 1/32	0.344	199	T311ARN1	T311ARN5	T311ARNB
4d	1 1/2	10	0.131	3/8	0.375	139	T410ARN1	T410ARN5	T410ARNB
4d	1 1/2	11	0.120	1 1/32	0.344	170	T411ARN1	T411ARN5	T411ARNB
5d	1 3/4	10	0.131	3/8	0.375	126	T510ARN1	T510ARN5	T510ARNB
6d	2	10	0.131	3/8	0.375	105	T610ARN1	T610ARN5	T610ARNB
6d	2	11	0.120	1 1/32	0.344	136	—	—	T611ARNB
8d	2 1/2	10	0.131	3/8	0.375	91	T810ARN1	T810ARN5	T810ARNB
10d	3	10	0.131	3/8	0.375	78	T1010ARN1	T1010ARN5	T1010ARNB

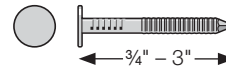

Type 304 Stainless Steel

Penny Size	Length (in.)	Gauge	Shank Diameter (in.)	Head Diameter (in.)	Approx. Count per lb.	1 lb. Model No.	5 lb. Model No.	25 lb. Bucket Model No.	
—	3/4	10	0.131	3/8	0.375	281	S7510ARN1	S7510ARN5	S7510ARNB
2d	1	10	0.131	3/8	0.375	212	S210ARN1	S210ARN5	S210ARNB
3d	1 1/4	10	0.131	3/8	0.375	166	S310ARN1	S310ARN5	S310ARNB
3d	1 1/4	11	0.120	3/8	0.375	199	S311ARN1	S311ARN5	S311ARNB
4d	1 1/2	10	0.131	3/8	0.375	139	S410ARN1	S410ARN5	S410ARNB
4d	1 1/2	11	0.120	3/8	0.375	170	S411ARN1	S411ARN5	S411ARNB
5d	1 3/4	10	0.131	3/8	0.375	126	S510ARN1	S510ARN5	S510ARNB
5d	1 3/4	11	0.120	3/8	0.375	149	S511ARN1	S511ARN5	S511ARNB
6d	2	10	0.131	3/8	0.375	105	S610ARN1	S610ARN5	S610ARNB
6d	2	11	0.120	3/8	0.375	136	S611ARN1	S611ARN5	S611ARNB
8d	2 1/2	10	0.131	3/8	0.375	91	S810ARN1	S810ARN5	S810ARNB
10d	3	10	0.131	3/8	0.375	78	S1010ARN1	S1010ARN5	S1010ARNB

These products are subject to quantities on hand or may require special ordering and are subject to minimum order quantities and longer lead times. Call Simpson Strong-Tie for details (800) 999-5099.

Exterior Nails

Roofing Nail — Annular Ring Shank (cont.)

Copper

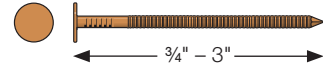

Penny Size	Length (in.)	Gauge	Shank Diameter (in.)	Head Diameter (in.)		Approx. Count per lb.	1 lb. Model No.	5 lb. Model No.	25 lb. Bucket Model No.
—	¾	11	0.120	¾	0.375	302	C7511ARN1	C7511ARN5	C7511ARNB
2d	1	10	0.131	7/16	0.438	187	C210ARN1	C210ARN5	C210ARNB
2d	1	11	0.120	¾	0.375	229	C211ARN1	C211ARN5	C211ARNB
3d	1¼	10	0.131	7/16	0.438	147	C310ARN1	C310ARN5	C310ARNB
3d	1¼	11	0.120	¾	0.375	187	C311ARN1	C311ARN5	C311ARNB
4d	1½	10	0.131	7/16	0.438	123	C410ARN1	C410ARN5	C410ARNB
4d	1½	11	0.120	¾	0.375	155	C411ARN1	C411ARN5	C411ARNB
5d	1¾	10	0.131	7/16	0.438	112	C510ARN1	C510ARN5	C510ARNB
5d	1¾	11	0.120	¾	0.375	139	C511ARN1	C511ARN5	C511ARNB
6d	2	10	0.131	7/16	0.438	93	C610ARN1	C610ARN5	C610ARNB
6d	2	11	0.120	¾	0.375	124	C611ARN1	C611ARN5	C611ARNB
8d	2½	10	0.131	7/16	0.438	81	C810ARN1	C810ARN5	C810ARNB
8d	2½	11	0.120	¾	0.375	108	—	—	C811ARNB
10d	3	10	0.131	7/16	0.438	67	C1010ARN1	C1010ARN5	C1010ARNB

Aluminum

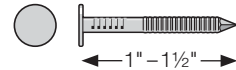

Penny Size	Length (in.)	Gauge	Shank Diameter (in.)	Head Diameter (in.)		Approx. Count per lb.	1 lb. Model No.	5 lb. Model No.	25 lb. Bucket Model No.
2d	1	11	0.120	¾	0.375	810	—	A211ARN5	A211ARNB
3d	1¼	11	0.120	¾	0.375	686	A311ARN1	A311ARN5	A311ARNB
4d	1½	11	0.120	¾	0.375	577	—	—	A411ARNB
3d	1¼	9	0.148	7/16	0.438	440	—	—	A39ARNB

Exterior Nails

Roofing Nail — Smooth Shank

Features:

- Large, flat head provides extra bearing surface to firmly secure roofing material
- Longer lengths ideal for installing curved Spanish roof tiles and thicker slate
- Aluminum nails also available with a screw shank; call Simpson Strong-Tie for details (800) 999-5099

Installation Tips:

- For slate roofs, determine the correct nail length by doubling the slate thickness and adding one inch

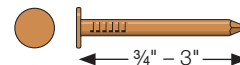

Copper

Penny Size	Length (in.)	Gauge	Shank Diameter (in.)	Head Diameter (in.)	Approx. Count per lb.	1 lb. Model No.	5 lb. Model No.	25 lb. Bucket Model No.
—	¾	11	0.120	¾	302	C7511RN1	C7511RN5	C7511RNB
2d	1	10	0.131	7/16	187	C210RN1	C210RN5	C210RNB
2d	1	11	0.120	¾	229	C211RN1	C211RN5	C211RNB
3d	1¼	10	0.131	7/16	147	C310RN1	C310RN5	C310RNB
3d	1¼	11	0.120	¾	187	C311RN1	C311RN5	C311RNB
4d	1½	10	0.131	7/16	123	C410RN1	C410RN5	C410RNB
4d	1½	11	0.120	¾	155	C411RN1	C411RN5	C411RNB
5d	1¾	10	0.131	7/16	112	C510RN1	C510RN5	C510RNB
5d	1¾	11	0.120	¾	139	C511RN1	C511RN5	C511RNB
6d	2	10	0.131	7/16	93	C610RN1	C610RN5	C610RNB
6d	2	11	0.120	¾	124	C611RN1	C611RN5	C611RNB
8d	2½	10	0.131	7/16	81	C810RN1	C810RN5	C810RNB
8d	2½	11	0.120	¾	108	C811RN1	C811RN5	C811RNB
10d	3	10	0.131	7/16	67	C1010RN1	C1010RN5	C1010RNB



Aluminum

Penny Size	Length (in.)	Gauge	Shank Diameter (in.)	Head Diameter (in.)	Approx. Count per lb.	1 lb. Model No.	5 lb. Model No.	25 lb. Bucket Model No.
2d	1	11	0.120	¾	810	—	—	A211RNB
3d	1¼	11	0.120	¾	686	A311RN1	—	A311RNB
4d	1½	9	0.148	7/16	374	A49RN1	A49RN5	A49RNB

These products are subject to quantities on hand or may require special ordering and are subject to minimum order quantities and longer lead times. Call Simpson Strong-Tie for details (800) 999-5099.

Exterior Nails

Tile/Slating Nail — Annular Ring Shank

Features:

- Large, flat head provides extra bearing surface to firmly secure roofing material
- Annular ring shank increases withdrawal resistance to provide a secure attachment to wood members and plywood roof decks
- Longer lengths ideal for installing curved Spanish roof tiles and thicker slate
- Aluminum nails also available with a screw shank; call Simpson Strong-Tie for details (800) 999-5099

Installation Tips:

- For slate roofs, determine the correct nail length by doubling the slate thickness and adding one inch

Type 304 Stainless Steel

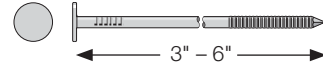

Penny Size	Length (in.)	Gauge	Shank Diameter (in.)	Head Diameter (in.)		Approx. Count per lb.	5 lb. Model No.	25 lb. Bucket Model No.
40d	5	8	0.162	½	0.500	28	S40ATN5	S40ATNB

Copper

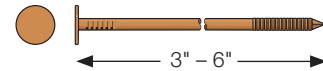

Penny Size	Length (in.)	Gauge	Shank Diameter (in.)	Head Diameter (in.)		Approx. Count per lb.	5 lb. Model No.	25 lb. Bucket Model No.
16d	3½	9	0.148	1⅝	0.469	48	—	C16HATNB

Exterior Nails

Tile/Slating Nail — Smooth Shank

Features:

- Large, flat head provides extra bearing surface to firmly secure roofing material
- Longer lengths ideal for installing curved Spanish roof tiles and thicker slate
- Aluminum nails also available with a screw shank; call Simpson Strong-Tie for details (800) 999-5099

Installation Tips:

- For slate roofs, determine the correct nail length by doubling the slate thickness and adding one inch

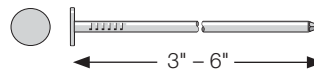

Type 304 Stainless Steel

Penny Size	Length (in.)	Gauge	Shank Diameter (in.)	Head Diameter (in.)		Approx. Count per lb.	5 lb. Model No.	25 lb. Bucket Model No.
40d	5	8	0.162	1/2	0.500	28	—	S40TNB

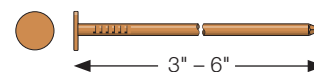

Copper

Penny Size	Length (in.)	Gauge	Shank Diameter (in.)	Head Diameter (in.)		Approx. Count per lb.	5 lb. Model No.	25 lb. Bucket Model No.
10d	3	9	0.148	1 5/32	0.469	57	—	C10TNB
16d	3 1/2	10	0.131	7/16	0.438	59	—	C16TNB
16d	3 1/2	9	0.148	1 5/32	0.469	48	—	C16HTNB
40d	5	8	0.162	1/2	0.500	28	—	C40TNB

These products are subject to quantities on hand or may require special ordering and are subject to minimum order quantities and longer lead times. Call Simpson Strong-Tie for details (800) 999-5099.

Custom Nail Worksheet

Instructions for Ordering Custom Nails

Simpson Strong-Tie offers a wide variety of custom-order nail options through our distribution network. Provide a print with complete specifications or complete this worksheet and have your Simpson Strong-Tie dealer send it to us for a price quote and lead time estimate; minimum quantities may apply. To better serve our customers, we employ a "Cut Close, Ship All" fulfillment methodology. Call (800) 999-5099 to find your closest dealer.

What is your Application? _____

Step 1: Choose Material

- | | |
|--|---|
| <input type="checkbox"/> Aluminum (Model No. SPEC NAIL NF) | <input type="checkbox"/> Type 304 Stainless Steel (Model No. SPEC NAIL 304SS) |
| <input type="checkbox"/> Copper (Model No. SPEC NAIL NF) | <input type="checkbox"/> Type 316 Stainless Steel (Model No. SPEC NAIL 316SS) |
| <input type="checkbox"/> Silicon Bronze (Model No. SPEC NAIL NF) | <input type="checkbox"/> Other
_____ |

Step 2: Choose Head Type

- | | |
|----------------------------------|---|
| <input type="checkbox"/> Brad | <input type="checkbox"/> Headless |
| <input type="checkbox"/> Casing | <input type="checkbox"/> Pyramid |
| <input type="checkbox"/> Clipped | <input type="checkbox"/> Other
_____ |

Step 3: Choose Head Surface

- | | |
|--|---|
| <input type="checkbox"/> Checker Pattern | <input type="checkbox"/> Flat / Smooth |
| <input type="checkbox"/> Circle Pattern | <input type="checkbox"/> Other
_____ |

Step 4: Specify Head Size (inches)

 (Some head diameters not possible in some materials)

Step 5: Specify Length (inches)

 (Length range ½" – 7")

Step 6: Specify Diameter (inches or gauge)

 (Diameter range 0.049" – 0.238")

Step 7: Choose Shank Type

- | | |
|---------------------------------------|---|
| <input type="checkbox"/> Annular Ring | <input type="checkbox"/> Spiral |
| <input type="checkbox"/> Smooth | <input type="checkbox"/> Other
_____ |

Step 8: Choose Point Type

- | | |
|----------------------------------|---|
| <input type="checkbox"/> Chisel | <input type="checkbox"/> Sheared |
| <input type="checkbox"/> Diamond | <input type="checkbox"/> Other
_____ |

Step 9: Choose Color/Finish (Optional)

- | | |
|----------------------------------|---|
| <input type="checkbox"/> Brown | <input type="checkbox"/> Tan |
| <input type="checkbox"/> Gray | <input type="checkbox"/> White |
| <input type="checkbox"/> Redwood | <input type="checkbox"/> Passivated |
| <input type="checkbox"/> Sienna | <input type="checkbox"/> Other
_____ |

Step 10: Choose Washer Type and size (Optional)

- | | |
|---|--|
| <input type="checkbox"/> EPDM | <input type="checkbox"/> Stainless Washer with Bonded EPDM |
| <input type="checkbox"/> ¾" | <input type="checkbox"/> 5/8" |
| <input type="checkbox"/> 5/8" | <input type="checkbox"/> 1 1/8" |
| <input type="checkbox"/> Other
_____ | <input type="checkbox"/> Other
_____ |

Step 11: Choose Packaging

- | | |
|------------------------------------|---|
| <input type="checkbox"/> 1 lb. Box | <input type="checkbox"/> 25 lb. Bucket |
| <input type="checkbox"/> 5 lb. Box | <input type="checkbox"/> Other
_____ |

Fasteners will be manufactured to the tolerances specified in ASTM F1667 unless otherwise specified.



**Easy installation
meets enduring
strength.**

Cement Board Screw



Specialty Fasteners

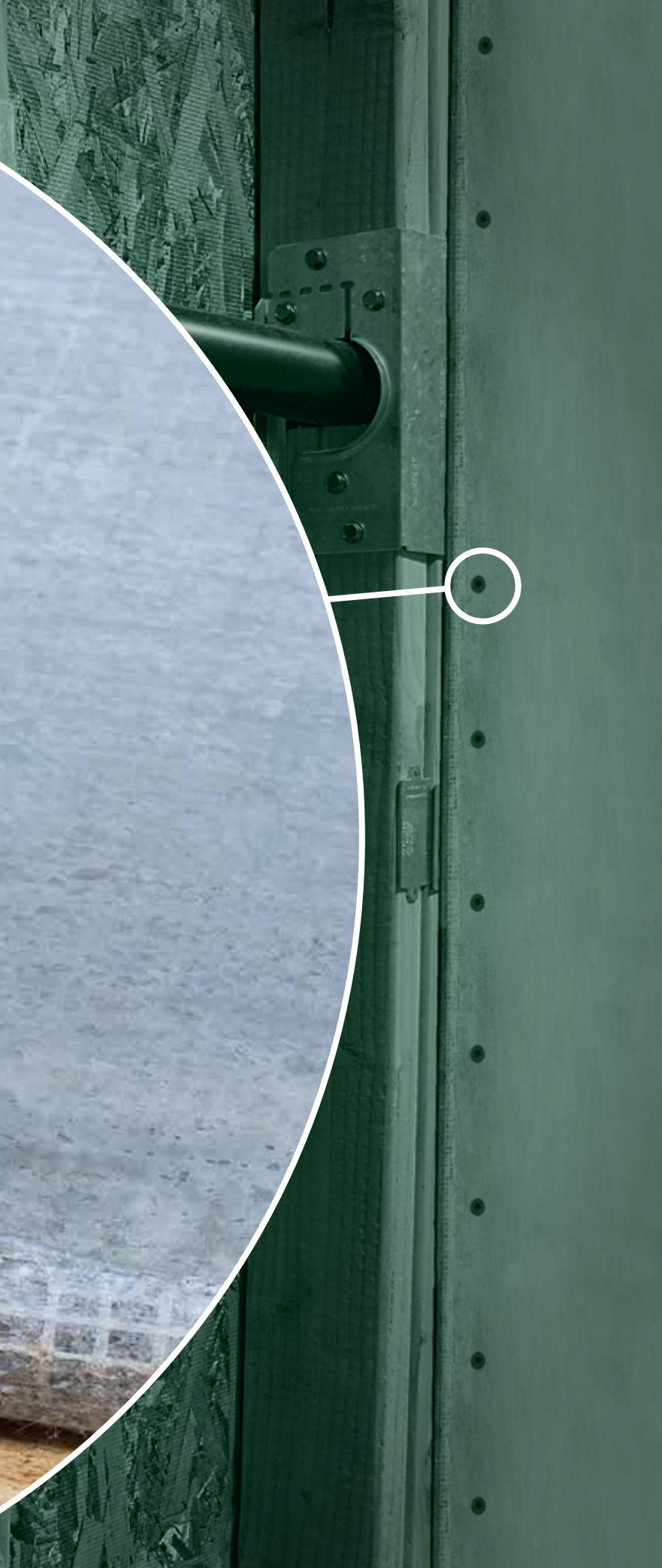

Strong-Drive® SCNR RING-SHANK CONNECTOR Nail	138
Strong-Drive® SCN SMOOTH-SHANK CONNECTOR Nail	139
PVC Trim-Board Nail	139
Escutcheon Pins	140
Fencing Staples	141
Hog Rings — Hill Pattern	141
Marine Screw — Pan Head	142
Marine Screw — Flat Head	143
PVC Trim-Board Screw	144
Cement Board Screw	145
Fiber-Cement Screw	145
Metal-Panel Screw	146
Metal-Panel Screw with EPDM Washer	146
Self-Drilling Hex-Washer-Head Screw	147
Self-Drilling Hex-Washer-Head Screw with EPDM Sealing Washer	148
Self-Drilling Flat-Pan-Head Screw	149
Pancake-Head Screw	149
PC Standing-Seam-Roofing Panel Clip Screw	150
Trim-Head Screw with EPDM Sealing Washer	150
Wire-Lath Modified Truss-Head Screw	151
Truss-Head Screw	151
Pocket-Hole Screw	152
Storm-Panel Screw	152
Specialty Washer for Nail and Screw Assemblies	153
EB-TY® Hidden Deck Fasteners	154
Ipê Wood Plugs	155

Specialty

Strong-Drive® SCNR RING-SHANK CONNECTOR Nail

For Simpson Strong-Tie® Connectors

Strong-Drive® SCNR Ring-Shank connector nails are the best choice for achieving full load values in connectors. Choose Type 316 stainless steel when using stainless steel connectors.

See p. 159 for collated Strong-Drive SCNR Ring-Shank Connector Nails.

For Technical Data and Loads, see p. 337

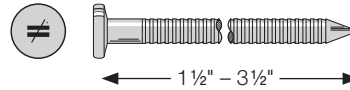

Type 316 Stainless Steel

Model No. Prefix	Length (in.)	Wire Gauge	Shank Diameter (in.)	Head Diameter (in.)	Approx. Count per lb.	1 lb. Model No.	1 lb. Box Model No.	5 lb. Box Model No.	25 lb. Bucket Model No.
SSNA8	1½	10	0.131	0.31	147	SSNA8	SSNA8D	SSNA8D5	SSNA8DB
SSA8D	2½	10	0.131	0.31	94	SSA8D	SSA8DD	SSA8D5	SSA8DB
SSNA10	1½	9	0.148	0.31	126	SSNA10	SSNA10D	SSNA10D5	SSNA10DB
SSA10D	3	9	0.148	0.31	66	SSA10D	SSA10DD	SSA10D5	SSA10DB
SSA16D	3½	8	0.162	0.34	44	SSA16D	SSA16DD	SSA16D5	SSA16DB

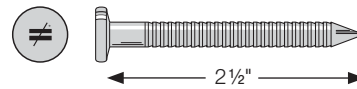

Hot-Dip Galvanized – Class D

Model No. Prefix	Length (in.)	Gauge	Shank Diameter (in.)	Head Diameter (in.)	Approx. Count per lb.	1 lb. Model No.	5 lb. Model No.	25 lb. Bucket Model No.
N54AHDG	2½	3½	0.250	0.500	27	N54AHDG – Sold by the pound		

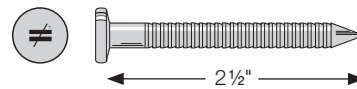

Bright

Model No. Prefix	Length (in.)	Gauge	Shank Diameter (in.)	Head Diameter (in.)	Approx. Count per lb.	1 lb. Model No.	5 lb. Model No.	25 lb. Bucket Model No.
N54A	2½	3½	0.250	0.500	27	N54A – Sold by the pound		

Bright nails are not for use in exterior or preservative-treated wood applications.

Specialty

Strong-Drive® SCN SMOOTH-SHANK CONNECTOR Nail

For Simpson Strong-Tie® Connectors

Simpson Strong-Tie Connector nails are the best choice for Simpson Strong-Tie connectors.

See p. 158 for collated Strong-Drive SCN Smooth-Shank Connector Nails.

For Technical Data and Loads, see p. 338

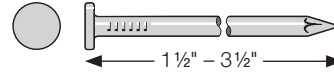

Hot-Dip Galvanized – Class D

Model No. Prefix	Length (in.)	Gauge	Shank Diameter (in.)	Head Diameter (in.)	Approx. Count per lb.	1 lb. Model No.	1 lb. Box Model No.	5 lb. Box Model No.
N8	1½	10	0.131	0.31	147	N8	N8DHDG-R	N8D5HDG-R
N10	1½	9	0.148	0.31	120	N10	N10DHDG-R	N10D5HDG-R
10D	3	9	0.148	0.31	50	—	10DHDG-R	10D5HDG-R
16D	3½	8	0.162	0.34	40	—	16DHDG-R	16D5HDG-R

PVC Trim-Board Nail

Specifically designed for use with PVC trim board. The spiral shank beginning of the nail allows the nail to smoothly work itself into the board. The ring-shank provides holding power. Nails that are fully ring shank can blast open the back of a trim board leading to a looser fit, while smooth nails or trim nails do not have the same holding power or strength. The PVC trim-board nail is the best of both worlds.

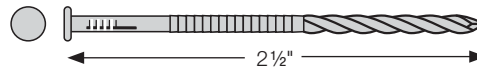

Type 316 Stainless Steel

Penny Size	Length (in.)	Screw Size/ Nail Gauge	Shank Dia. (in.)	Head Dia. (in.)	Shank	Head Type	Point	Count per lb. (approx)	Package Size	Model No.
8d	2½	13	0.092	0.21	Spiral/Ring shank	Checkered head	Diamond point	196	1,000	T8VTN1000



White

Specialty

Escutcheon Pins

Features:

- Oval head with diamond point
- Other materials are available for special-order; call Simpson Strong-Tie for details (800) 999-5099

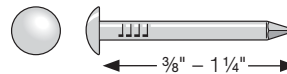

Type 304 Stainless Steel

Length (in.)	Wire Gauge	Shank Diameter (in.)	Head Diameter (in.)		Approx Count per lb.	1/8 lb. Model No.	1 lb. Model No.	5 lb. Model No.
3/8	18	0.049	1/10	0.100	3,900	518037EP18	—	—
1/2	18	0.049	1/10	0.100	3,000	518050EP18	S18050EP1	—
3/4	18	0.049	1/10	0.100	2,500	518075EP18	—	—
1	18	0.049	1/10	0.100	1,700	518100EP18	—	—
3/8	16	0.065	1/8	0.125	2,400	516037EP18	—	—
1/2	16	0.065	1/8	0.125	1,670	516050EP18	S16050EP1	S16050EP5
5/8	16	0.065	1/8	0.125	1,395	516062EP18	S16062EP1	S16062EP5
3/4	16	0.065	1/8	0.125	1,200	516075EP18	S16075EP1	S16075EP5
1	16	0.065	1/8	0.125	1,000	516100EP18	—	—
1 1/4	16	0.065	1/8	0.125	750	—	—	—
1/2	14	0.083	4/25	0.160	980	—	S14050EP1	S14050EP5
3/4	14	0.083	4/25	0.160	700	514075EP18	—	S14075EP5
1	14	0.083	4/25	0.160	550	514100EP18	S14100EP1	S14100EP5
1 1/4	14	0.083	4/25	0.160	450	514125EP18	—	—
1/2	14	0.083	4/25	0.160	380	514150EP18	—	—
1/2	12	0.113	3/8	0.223	625	512050EP18	—	—
3/4	12	0.113	3/8	0.223	454	512075EP18	—	—

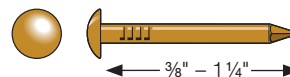

Brass

Length (in.)	Wire Gauge	Shank Diameter (in.)	Head Diameter (in.)		Approx Count per lb.	1/8 lb. Model No.	1 lb. Model No.	5 lb. Model No.
3/8	18	0.049	1/10	0.100	3,900	—	—	—
1/2	18	0.049	1/10	0.100	3,000	B18050EP18	B18050EP1	—
3/4	18	0.049	1/10	0.100	2,500	B18075EP18	—	—
1	18	0.049	1/10	0.100	1,700	B18100EP18	—	—
3/8	16	0.065	1/8	0.125	2,400	—	—	—
1/2	16	0.065	1/8	0.125	1,670	—	B16050EP1	—
5/8	16	0.065	1/8	0.125	1,395	—	B16062EP1	—
3/4	16	0.065	1/8	0.125	1,200	—	B16075EP1	B16075EP5
1	16	0.065	1/8	0.125	1,000	—	B16100EP1	B16100EP5
1 1/4	16	0.065	1/8	0.125	750	—	B16125EP1	B16125EP5
1/2	14	0.083	4/25	0.160	980	—	—	B14050EP5
3/4	14	0.083	4/25	0.160	700	—	B14075EP1	—
1	14	0.083	4/25	0.160	550	—	—	—
1 1/4	14	0.083	4/25	0.160	450	—	B14125EP1	—
1/2	14	0.083	4/25	0.160	380	—	B14150EP1	—
1/2	12	0.113	3/8	0.223	625	B12050EP18	—	—
3/4	12	0.113	3/8	0.223	454	B12075EP18	—	—

These products are subject to quantities on hand or may require special ordering and are subject to minimum order quantities and longer lead times. Call Simpson Strong-Tie for details (800) 999-5099.

Specialty

Fencing Staples

Type 304 Stainless Steel

Length (in.)	Screw Size/Nail Gauge	Count per lb. (approx)	Package Size	Model No.
1	13	291	1 lb.	S13100FS1
1	13	291	5 lb.	S13100FS5
1	13	291	25 lb.	S13100FSB
1¼	13	202	1 lb.	S13125FS1
1¼	13	202	5 lb.	S13125FS5
1¼	13	202	25 lb.	S13125FSB
2	10	66	1 lb.	S10200FS1
2	10	66	5 lb.	S10200FS5
2	10	66	25 lb.	S10200FSB

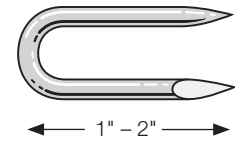

Hog Rings — Hill Pattern

Features:

- #3 pre-bent

Type 304 Stainless Steel

Gauge	Width Open (in.)	Width Across (in.)	Approx. Count per lb.	1 lb. Model No.	5 lb. Model No.	25 lb. Bucket Model No.
13	0.812	1.57	204	S13075HR1	S13075HR5	S13075HRB
14	0.280	0.75	540	S14075HR1	S14075HR5	S14075HRB

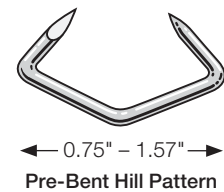

Specialty

Marine Screw — Pan Head

Common Applications:

Designed to fasten securely in fiberglass, plywood and wood-substitute materials in applications exposed to harsh marine or many chemically-caustic conditions. Ideal for applying trim, rub rail and molding to fiberglass boat hulls.

Features:

- Specially engineered, high/low thread form incorporates indentations (“teeth”) that cut easily and quickly through high-density materials
- Extra-sharp points speed screw starts during assembly
- Screws up to 1" in length are fully threaded; screws more than 1" long are threaded $\frac{2}{3}$ of the shank length
- #2 Phillips drive (sizes #6, #8, #10)
- #3 Phillips drive (sizes #12, #14)

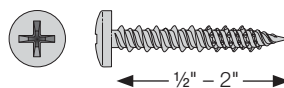

Type 316 Stainless Steel

Size	Length (in.)	Head Diameter (in.)	Nominal Screw Diameter (in.)	100-Count Model No.	1,000-Count Model No.
#6	1/2	0.26	0.138	T06J050PXC	T06J050PXM
#6	3/4	0.26	0.138	T06J075PXC	T06J075PXM
#8	3/4	0.31	0.164	T08J075PXC	T08J075PXM
#10	3/4	0.37	0.190	T10J075PXC	T10J075PXM
#8	1	0.31	0.164	T08J100PXC	T08J100PXM
#10	1	0.37	0.190	T10J100PXC	T10J100PXM
#12	1	0.42	0.216	T12J100PXC	T12J100PXM
#8	1 1/4	0.31	0.164	T08J125PXC	T08J125PXM
#10	1 1/4	0.37	0.190	T10J125PXC	T10J125PXM
#8	1 1/2	0.31	0.164	T08J150PXC	T08J150PXM
#10	1 1/2	0.37	0.190	T10J150PXC	T10J150PXM
#12	1 1/2	0.42	0.216	T12J150PXC	T12J150PXM
#12	2	0.42	0.216	T12J200PXC	T12J200PXM

Specialty

Marine Screw — Flat Head

Common Applications:

Designed to fasten securely in fiberglass, plywood and wood-substitute materials in applications exposed to harsh marine or many chemically-caustic conditions. Ideal for applying trim, rub rail and molding to fiberglass boat hulls.

Features:

- Specially engineered, high/low thread form incorporates indentations (“teeth”) that cut easily and quickly through high-density materials
- Extra-sharp points speed screw starts during assembly
- Screws up to 1" in length are fully threaded; screws more than 1" long are threaded $\frac{2}{3}$ of the shank length
- #2 Phillips drive

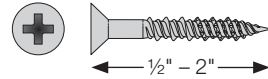

Type 316 Stainless Steel

Size	Length (in.)	Head Diameter (in.)	Nominal Screw Diameter (in.)	100-Count Model No.	1,000-Count Model No.
#6	1/2	0.26	0.138	T06J050FXC	T06J050FXM
#6	3/4	0.26	0.138	T06J075FXC	T06J075FXM
#8	3/4	0.31	0.164	T08J075FXC	T08J075FXM
#6	1	0.26	0.138	T06J100FXC	T06J100FXM
#8	1	0.31	0.164	T08J100FXC	T08J100FXM
#10	1	0.36	0.190	T10J100FXC	T10J100FXM
#8	1 1/4	0.31	0.164	T08J125FXC	T08J125FXM
#8	1 1/2	0.31	0.164	T08J150FXC	T08J150FXM
#10	1 1/2	0.36	0.190	T10J150FXC	T10J150FXM
#10	2	0.36	0.190	T10J200FXC	T10J200FXM

Specialty

PVC Trim-Board Screw

PVC Trim and Fascia Applications

The new PVC Trim-Board screw is a special-purpose fastener engineered for easy installations of exterior PVC trim and fascia onto wood. The fastener's triple-thread design allows for low-torque driving and increased holding power.

The box-shaped cutter head bores through PVC materials, stripping away excess during countersinking, while the flat-washer underhead provides for less board pull-through and a clean, flush finish.

The PVC Trim-Board screw is available in a white exterior-grade coating that provides medium-level corrosion resistance, making it ideal for outdoor applications where the fastener blends into popular white PVC trim.

Features:

- Unique box-shaped cutter head
- Triple-thread design for low-torque driving and holding boards securely
 - Optimized-thread pattern draws members together tightly
 - Low-torque threads for easy driving
 - High-low threaded tip for fast starts
- 6-lobe drive reduces driver-bit cam-outs for easier installations and longer bit life – T-20 bit included
- White exterior-grade coating blends with popular white trim boards

Simpson Strong-Tie internal test results indicate that the PVC Trim-Board Screw provides higher pull-through resistance than other trim-head screws.

U.S. Patent Pending

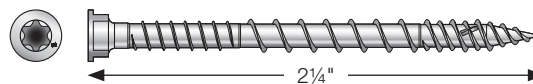

White Exterior-Grade Coating

Size	Length (in.)	Point Type	Model No.	Quantity
#8	2 1/4"	High-low thread	TSV214R70WH01	70

Specialty

Cement Board Screw

Cement Board Fastening Applications

Designed for Use in All Cement Backerboards Including HardieBacker®, Durock®, WonderBoard® and PermaBase®

The ANSI-A108 compliant Cement Board screw is designed for ease of installation and long life. With its corrosion-resistant coating, the Cement Board screw is ideal for use in all tile backerboards.

Features:

- Deep 6-lobe T-25 recess drive reduces cam-outs
- High-low thread for easier driving
- Wafer-head with nibs provides a flush finish
- Distinctive multilayer corrosion-resistant coating prevents rust stains

Codes/Standards: ANSI-A108 compliant

Coated Zinc

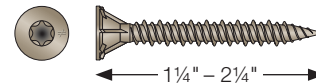

Length (in.)	Size	Head Dia. (in.)	Drive Type	Retail Pack		Contractor Pack	
				Fasteners per Pack	Model No.	Fasteners per Pack	Model No.
1 1/4	#8	0.38	T-25	200	CBHL114R200	800	CBHL114R800
1 5/8	#8	0.38	T-25	150	CBHL158R150	600	CBHL158R600
2 1/4	#8	0.38	T-25	100	CBHL214R100	—	—

1. Corrosion resistance: No red rust after 500 hours of ASTM B117 exposure.

2. Replacement driver bit: BIT25T-2-RC3.

HardieBacker®, Durock®, WonderBoard® and PermaBase® are trademarks of their respective companies.

Fiber-Cement Screw

Features:

- Wafer head with self-countersinking nibs
- Type 17 point for fast starts
- Full-length coarse thread (to within 5/16" of head)
- Driver bit included in each package
- Use 1 1/4" screws to attach fiber cement siding to stress skin panels
- Use 1 5/8" screws to blind-fasten fiber cement lap siding to wood
- #2 square drive (replacement bit model BIT2S-2; see p. 111 for more information)

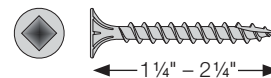

Type 316 Stainless Steel

Size	Length (in.)	Head Diameter (in.)	Carton Quantity	Model No.
#8	1 1/4	0.39	100	T08C125WQC
#8	1 1/4	0.39	1,000	T08C125WQM
#8	1 5/8	0.39	100	T08C162WQC
#8	1 5/8	0.39	1,000	T08C162WQM
#8	2 1/4	0.39	100	T08225WQ1
#8	2 1/4	0.39	1,000	T08C225WQM
#8	2 1/4	0.39	2,000	T08C225WQC

Specialty

Metal-Panel Screw

Common Applications:

Aluminum agricultural siding panels to wood joists without pre-drilling

Features:

- Extra-sharp point for quick penetration of aluminum panels without "point walking"
- Twin-lead thread fastens one to three panel thicknesses securely to wood substrate
- ¼" hex drive
- Limited models available in Type 305 stainless steel; call Simpson Strong-Tie for availability (800) 999-5099

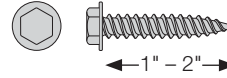

Type 316 Stainless Steel

Size	Length (in.)	Head Diameter (in.)	Carton Quantity	Model No.
#9	1	0.40	100	T09100HWHC
#9	1	0.40	1,000	T09100HWHM
#9	1½	0.40	100	T09150HWHC
#9	1½	0.40	1,000	T09150HWHM
#9	2	0.40	100	T09200HWHC
#9	2	0.40	1,000	T09200HWHM

Metal-Panel Screw with EPDM Washer

Common Applications:

Aluminum agricultural siding panels to wood joists without pre-drilling

Features:

- Extra-sharp point for quick penetration of aluminum panels without "point walking"
- Twin-lead thread fastens one to three panel thicknesses securely to wood substrate
- Type 316 stainless-steel washers
- ¼" hex drive
- Limited models available in Type 305 stainless steel; call Simpson Strong-Tie for availability (800) 999-5099

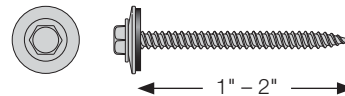

Type 316 Stainless Steel

Size	Length (in.)	Washer Diameter (in.)	Carton Quantity	Model No.
#9	1	5/8	100	T09100HWAC
#9	1	5/8	1,000	T09100HWAM
#9	1½	5/8	100	T09150HWAC
#9	1½	5/8	1,000	T09150HWAM
#9	2	5/8	100	T09200HWAC
#9	2	5/8	1,000	T09200HWAM

Specialty

Self-Drilling Hex-Washer-Head Screw

Common Applications:

Aluminum and fiberglass fastening (*not steel*)

Features:

- Indented hex-washer head
- Tapping screw thread
- #3 drill point

For more information on drilling thickness capacities and drill speed recommendations, see pp. 27–28.

Types 316 and 305 stainless steel provide superior corrosion resistance and are suitable for softer materials such as aluminum and fiberglass (*not steel*).

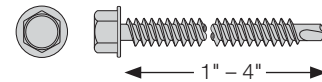

Type 316 Stainless Steel

Size	Length (in.)	Hex Head Size (in.)	Threads Per Inch	Carton Quantity	Model No.
#8	1	¼	18	100	T08100HDUC
#8	1	¼	18	1,000	T08100HDUM
#12	1	⅝	14	100	T12100HDUC
#12	1	⅝	14	1,000	T12100HDUM
#12	1½	⅝	14	100	T12150HDUC
#12	1½	⅝	14	1,000	T12150HDUM
#12	2	⅝	14	100	T12200HDUC
#12	2	⅝	14	1,000	T12200HDUM
#12	2½	⅝	14	100	T12250HDUC
#12	2½	⅝	14	1,000	T12250HDUM
#12	3	⅝	14	100	T12300HDUC
#12	3	⅝	14	1,000	T12300HDUM
#12	4	⅝	14	100	T12400HDUC
#12	4	⅝	14	1,000	T12400HDUM

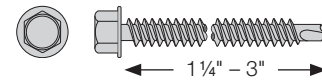

Type 305 Stainless Steel

Size	Length (in.)	Hex Head Size (in.)	Threads Per Inch	Carton Quantity	Model No.
#12	1¼	⅝	14	100	S12125HDUC
#12	1¼	⅝	14	1,000	S12125HDUM
#12	1½	⅝	14	100	S12150HDUC
#12	1½	⅝	14	1,000	S12150HDUM
#12	2	⅝	14	100	S12200HDUC
#12	2	⅝	14	1,000	S12200HDUM
#12	2½	⅝	14	100	S12250HDUC
#12	2½	⅝	14	1,000	S12250HDUM
#12	3	⅝	14	100	S12300HDUC
#12	3	⅝	14	1,000	S12300HDUM

Specialty

Self-Drilling Hex-Washer-Head Screw with EPDM Sealing Washer

Common Applications:

Aluminum and fiberglass fastening (*not steel*)

Features:

- Indented hex-washer head
- Washers are Type 316 stainless steel for 316 stainless-steel screws and Type 305 stainless steel for 305 stainless-steel screws
- Tapping screw thread
- #3 drill point

For more information on drilling thickness capacities and drill speed recommendations, see pp. 27–28.

Types 316 and 305 stainless steel provide superior corrosion resistance and are suitable for softer materials such as aluminum and fiberglass (*not steel*).

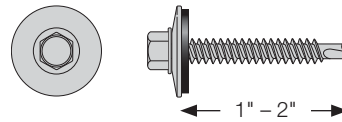

Type 316 Stainless Steel

Size	Length (in.)	Threads Per Inch	Hex Head Size (in.)	Washer Diameter (in.)	Carton Count	Model No.
#12	1	14	5/16	5/8	100	T12100XOC
#12	1	14	5/16	5/8	1,000	T12100XOM
#12	1½	14	5/16	5/8	100	T12150XOC
#12	1½	14	5/16	5/8	1,000	T12150XOM
#12	2	14	5/16	5/8	100	T12200XOC
#12	2	14	5/16	5/8	1,000	T12200XOM

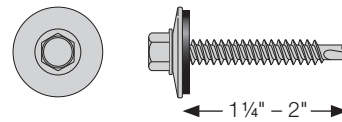

Type 305 Stainless Steel

Size	Length (in.)	Threads Per Inch	Hex Head Size (in.)	Washer Diameter (in.)	Carton Count	Model No.
#12	1¼	14	5/16	5/8	100	S12125HOC
#12	1¼	14	5/16	5/8	1,000	S12125HOM
#12	1½	14	5/16	5/8	100	S12150HOC
#12	1½	14	5/16	5/8	1,000	S12150HOM
#12	2	14	5/16	5/8	100	S12200HOC
#12	2	14	5/16	5/8	1,000	S12200HOM

Specialty

Self-Drilling Flat-Pan-Head Screw

Common Applications:

Aluminum and fiberglass fastening (*not steel*)

Features:

- Fully threaded
- #3 drill point
- #2 square drive (replacement bit BIT2S-2; see p. 111 for more information)

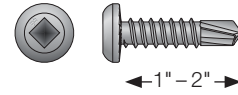

Type 305 Stainless Steel

Size	Length (in.)	Threads Per Inch	Head Diameter (in.)	Drill Point Size	Carton Quantity	Model No.
#10	1	16	0.37	#3	25	S10T100PDQ25
#10	1	16	0.37	#3	1,000	S10T100PDM
#10	1¼	16	0.37	#3	25	S10T125P25
#10	1¼	16	0.37	#3	1,000	S10T125PDM
#10	1½	16	0.37	#3	25	S10T150P25
#10	1½	16	0.37	#3	1,000	S10T150PDM
#10	2	16	0.37	#3	25	S10T200P25
#10	2	16	0.37	#3	1,000	S10T200PDM

Pancake-Head Screw

Common Applications:

Securing clips to wood used in standing-seam-roofing

Features:

- Low-profile head
- #2 square drive (replacement bit BIT2S-2; see p. 111 for more information)
- Fully-threaded shank
- Type 410 stainless steel is coated for additional corrosion protection

Type 410 stainless steel can be hardened through heat treatment, giving it the ability to drill through metal. It does not offer the same level of corrosion resistance of either Type 316 or 305 stainless steel.

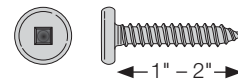

Type 410 Stainless Steel*

Size	Length (in.)	Head Diameter (in.)	Carton Quantity	Model No.
#10	1	0.44	100	F10T100PTC
#10	1	0.44	1,000	F10T100PTM
#10	1	0.44	4,500	F10T100PTB
#10	2	0.44	100	F10T200PTC
#10	2	0.44	1,000	F10T200PTM

* These products are subject to quantities on hand or may require special ordering and are subject to minimum order quantities and longer lead times. Call Simpson Strong-Tie for details (800) 999-5099.

Specialty

PC Standing-Seam-Roofing Panel Clip Screw

Common Application:

Standing-seam-roofing panel clips to wood

Features:

- Pancake head
- #2 square drive
- Type-17 point

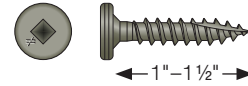

Quik Guard® Coating

Size	Length (in.)	Thread Per Inch	Head Diameter (in.)	Carton Quantity	Model No.
#10	1	12	0.41	5,000	PCQ1B1012-5K
#10	1½	12	0.41	4,000	PCQ112B1012-4K
#12	1	11	0.41	4,000	PCQ1B1211-4K

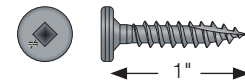

Clear Zinc Coating

Size	Length (in.)	Thread Per Inch	Head Diameter (in.)	Carton Quantity	Model No.
#10	1	12	0.41	5,000	PC1B1012-5K
#12	1	11	0.41	4,000	PC1B1211-4K

Trim-Head Screw with EPDM Sealing Washer

Common Application:

Assemblies provide weathertight seal for use in exterior sheathing and roofing applications.

Features:

- #1 square drive (replacement bit model BIT1S-2; see p. 111 for more information)
- Washers are 5/8" in diameter and are made from Type 305 stainless steel with an EPDM gasket
- Type-17 point
- Other sizes are available for special-order; call Simpson Strong-Tie for details (800) 999-5099

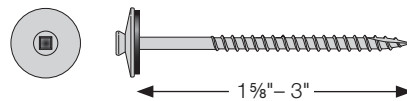

Type 305 Stainless Steel

Size	Length (in.)	Washer Diameter (in.)	Carton Quantity	Model No.
#7	1½	5/8	1,000	S07C162X0M

Specialty

Wire-Lath Modified Truss-Head Screw

Common Application:

Fastening lath to wood

Features:

- For use in applications where a larger bearing surface is needed underneath the head
- #2 Phillips drive
- Type-17 point

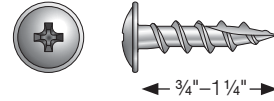

Type 305 Stainless Steel

Size	Length (in.)	Head Diameter (in.)	Carton Quantity	Model No.
#8	¾	0.42	100	S08C075KQC
#8	¾	0.42	1,000	S08C075KQM
#8	1¼	0.42	100	S08C125KQC
#8	1¼	0.42	1,000	S08C125KQM

Truss-Head Screw

Common Application:

Fasten all materials to wood or wood-substitute materials

Features:

- Square drive
- Type-17 point
- Coarse thread
- Pre-drilling recommended dependent on substrate
- Oversized head
- #2 square drive (replacement bit model BIT2S-2; see p. 111 for more information)

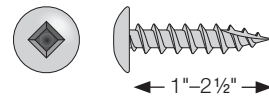

Type 305 Stainless Steel

Size	Length (in.)	Head Diameter (in.)	Carton Quantity	Model No.
#8	1	0.37	100	S08C100TSC
#8	1	0.37	1,000	S08C100TSM
#8	1	0.37	2,000	S08100TSBC
#8	1¼	0.37	100	S08C125TSC
#8	1¼	0.37	1,000	S08C125TSM
#8	1¼	0.37	2,000	S08125TSBC
#8	1½	0.37	100	S08C150TSC
#8	1½	0.37	1,000	S08C150TSM
#8	1½	0.37	2,000	S08150TSBC
#8	2½	0.37	100	S08C250TSC
#8	2½	0.37	1,000	S08C250TSM
#8	2½	0.37	2,000	S08250TSBC

Specialty

Pocket-Hole Screw

Common Application:

Pocket-holes for finish work and cabinetry

Features:

- Type-17 point
- #2 square drive
(replacement bit model BIT2S-2;
see p. 111 for more information)

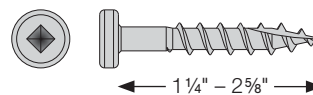

Type 305 Stainless Steel

Size	Length (in.)	Head Diameter (in.)	Carton Quantity	Model No.
#10	1 1/4	0.36	1,500	S10125PHB
#10	2 5/8	0.36	1,500	S10262PHB

Storm-Panel Screw

Common Application:

Ideal for attaching storm panels to wood, concrete and masonry

Features:

- Save time and money with a single installation
- The screw is made of Type 302 stainless steel for corrosion resistance

Each Pack Contains:

- (25) Stainless-steel storm-panel screws 1/4" x 3 7/16"
- (25) 1/4" zinc die-cast washered wing nuts
- (25) White plastic caps to protect threads after panels are removed
- (1) Hex-driver bit for panel screw
- (1) 0.234" x 4 1/2" carbide-tipped drill bit

Installation:

1. Drill a hole in the concrete or masonry base material using the drill bit provided. To pre-drill into wood, use a 3/16" bit (not included).
2. Drive the screw using the hex-driver bit (included). Drive the screw to fully embed the coarse-threaded shank such that the threaded stud for the wing nut is fully exposed.
3. To secure panels: install the panel on the threaded stud and secure with the wing nut.
4. To remove panels: remove the wing nut, remove the panel, then cover the threaded stud with the plastic cap.

Storm-Panel Screw Pack

Size (in.)	Length (in.)	Model No.
1/4	3 7/16	SPS25344-KT

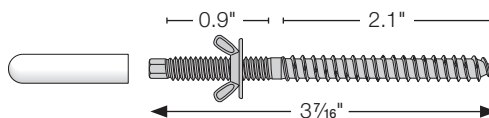

Storm-Panel Screw Replacement Parts

Description	Carton Qty.	Model No.
1/4" white plastic caps	100	PCAPS100
1/4" zinc die-cast washered wing nuts	100	Z25CWWNC

Specialty

Specialty Washer for Nail and Screw Assemblies

Bonded-EPDM washers provide a weather-resistant seal for exterior sheathing and roofing applications.

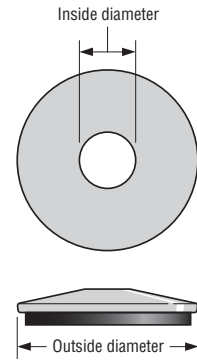

Type 316 Stainless Steel

Inside Diameter	Outside Diameter (in.)	Carton Count	Model No.
#10	5/8	100	T10N062SWC
#12	5/8	1,000	T12N062SWM
#14	1 1/8	100	T25N112SWC

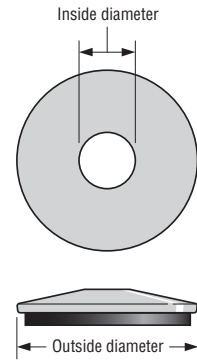

Type 304 Stainless Steel

Inside Diameter	Outside Diameter (in.)	Carton Count	Model No.
#10	5/8	100	S10N062SWC
#10	5/8	1,000	S10N062SWM
#12	5/8	100	S12N062SWC
#12	5/8	1,000	S12N062SWM

Specialty

EB-TY® Hidden Deck Fasteners

The EB-TY provides a unique method of fastening deck boards that makes the fasteners virtually invisible. Fastening is done into the side of the deck board and the edge of the framing member, leaving a fastener-free deck surface.

The EB-TY is a polypropylene biscuit fastener that fits into a pre-cut deck board or into a slot the builder cuts into the edge of the deck boards with a standard biscuit joiner. The EB-TY fasteners are inserted and fastened with a screw driven through the biscuit and into the joist. Nesting each successive board against the EB-TY automatically ensures consistent spacing and uniform height.

Features:

- Easy to install since all fastening is done from the top side
- Affords easier deck resurfacing because fastener heads are below the deck surface
- Formed from long-lasting polypropylene to last the life of the deck
- Stainless-steel #7 trim-head screws included (*black head, 6-lobe T-15 drive*)
- Each EB-TY package includes installation instructions and enough EB-TY fasteners, screws and tapered Ipê wood plugs to install 100 square feet of decking (*175-Pack quantity assumes 6" wide boards, installed perpendicular to joists spaced 16" on center*)

U. S. Patents: 6,402,415 and 7,578,105



Specialty

Working from left to right, compare the information in the columns to your application to select the correct EB-TY for the job.

Decking Material	Decking Thickness (in.)	Spacing Requirement (in.)	Special Application Information	Biscuit Model No.	Ordering Information	
					Pack Quantity	Pack Model No.
Ipê	1+	3/32	N/A	EBE004	100	100-EB TYS
Redwood					175	175-EB TYS
Cedar					275	275-EB TYS
PVC					175	175-EB TYW*
Ipê	1+	3/32	1 5/8" screw included for installation on roof-deck sleepers	EBE004	175	175-EB162
Redwood						
Cedar						
PVC						
Ipê	1 1/16 +	3/32	N/A	EBE007MINI	100	100-EBTYMI
Redwood						
Cedar						
PVC					175	175-EBTYMI
Docks	2x4 and 2x6	1/4	N/A	EBE002	175	175-EBTYBG
Boardwalks						
Kiln-dried	1+	1/4	"Live Cylinder" design for expansive material	EBE005LC	100	100-EBTYLC
Composites					175	175-EBTYLC
Kiln-dried	1 1/16 +	1/4	"Live Cylinder" design for expansive material	EBE006JR	175	175-EBTYJR
Composites					100	100-EBTYJR
Timber Tech®	7/8 +	3/16	N/A	316-TT	175	175-EB TT
PVC/Composite	7/8 +	1/8	N/A	EBEOA	175	175-EBAOSQ
Composites	7/8 +	3/16	N/A	TP015	175	175-EBTYP

* Comes with Type 316 stainless-steel fastener.



Model EBE004



Model EBE007MINI



Model EBE002



Model EBE005LC



Model EBE006JR



Model 316TT



Model EBEOA



Model TP015

Ipê Wood Plugs

Features:

- Made of high-quality Ipê and tapered for ease of use
- For use on decks using the EB-TY® system (first boards, aprons, etc.); also stairs and railings



Plug Diameter (in.)	Plug Length (in.)	Count Quantity	Model No.
3/8	7/16	100	WDPLUG-100
3/8	7/16	2,000	WDPLUG2M

**Unconditional speed
and performance.**



Strong-Drive® 33° SCNR RING-SHANK CONNECTOR Nail



Collated Nails and Staples



Strong-Drive® Connector Nails

33° SCN SMOOTH-SHANK CONNECTOR Nail	158
33° SCNR RING-SHANK CONNECTOR Nail	159

Siding/Fencing/Trim

0° Inserted Plastic Coil, Ring-Shank Nail	160
15° Inserted Plastic Coil, Ring-Shank Nail	161
15° Inserted Plastic Coil, White, Ring-Shank Nail	162
15° Wire Coil, Ring-Shank Siding Nail	163
15° Wire Coil, Painted, Ring-Shank Nail	164

Roofing

15° Wire Coil, Ring-Shank Roofing Nail	165
15° Wire Coil, Smooth-Shank Roofing Nail	166

Framing

15° Wire Coil, Ring-Shank Decking/Framing Nail	167
15° Wire Coil, Painted, Ring-Shank Decking/Framing Nail	168
20°-22° Plastic Strip, Casing Head, Ring-Shank Nail	169
20°-22° Plastic Strip, Ring-Shank Nail	170
20°-22° Plastic Strip, Screw-Shank Nail	171
20°-22° Plastic Strip, Smooth-Shank Nail	172
31°-34° Plastic Strip, Ring-Shank Nail	173
28° Wire-Weld, Clipped Head, Ring-Shank Nail	174
31°-34° Paper Tape, Clipped Head, Ring-Shank Nail	175

Trim Nails

20° Angle, Adhesive Collation, 16-Gauge Finishing Nail	176
25° Angle, Adhesive Collation, 15-Gauge Finishing Nail	176
Straight, Adhesive Collation, 16-Gauge Finishing Nail	177
Straight, Adhesive Collation, 18-Gauge, Brads	178
Straight, Adhesive Collation, 23-Gauge, Micro Pins	179
33° Tape Collation, 15-Gauge Finishing Nail	180

Specialty

L Series Flooring Cleats	181
T Series Flooring Cleats	181

Staples

½" Crown, 15½-Gauge Staples	182
1" Crown, 16-Gauge Staples	182
½" Crown, 16-Gauge Staples	183
¼" Crown, 18-Gauge Staples	184
7/16" Crown, 16-Gauge Staples	185

Connector Nails

Strong-Drive® 33° SCN SMOOTH-SHANK CONNECTOR Nail

Features:

- 33° collation angle
- Full round head
- Smooth head

See p. 139 for bulk Strong-Drive® SCN Smooth-Shank Connector Nails.

For Technical Data and Loads, see p. 338

Compatible Pneumatic Tools

If you don't see your particular model in the table below, see strongtie.com/toolmatrix or call Simpson Strong-Tie for assistance with fastener selection (800) 999-5099.

Bostitch®	MCN150 (up to 1½"), MCN250, F33PT
Grip-Rite®	GR150 (up to 1½"), GRSB150-1½ (up to 1½"), GR250, GRSB250-2½
Hitachi®	NR65AK
Paslode®	PF150S-PP (up to 1½"), F250S-PP
Senco®	HN150 (up to 1½"), HN250

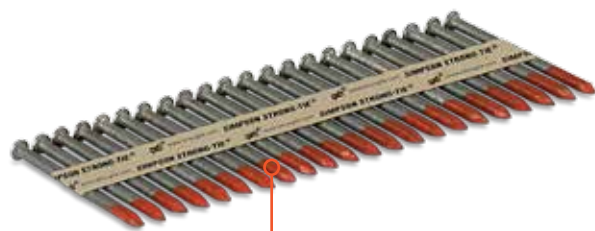

Orange Painted Tip for Better Visibility

SCN Smooth-Shank Head Stamps



Type Hot-Dip Galvanized — Class D

Length (in.)	Shank Diameter (in.)	Head Diameter (in.)	Carton Quantity	Model No.	Replacement for
1½	0.131	0.285	500	N8HDGPT500	8d x 1½"
			4,000	N8HDGPT4000	
2½	0.131	0.285	500	8DHDGPT500	8d common
			2,500	8DHDGPT2500	
1½	0.148	0.285	500	N10HDGPT500	10d x 1½"
			3,000	N10HDGPT3000	
2½	0.148	0.285	500	N10DHDGPT500	10d x 2½"
			2,500	N10DHDGPT2500	
2½	0.162	0.285	500	N16HDGPT500	16d x 2½"
			2,000	N16HDGPT2000	

Hot-dip galvanized per ASTM A153

Type Bright

Length (in.)	Shank Diameter (in.)	Head Diameter (in.)	Carton Quantity	Model No.	Replacement for
1½	0.131	0.285	4,000	N8BRPT4000	8d x 1½"
2½			2,500	8DBRPT2500	8d common
1½	0.148	0.285	3,000	N10BRPT3000	10d x 1½"
2½			2,500	N10DBRPT2500	10d x 2½"

Type Electro-Galvanized

Length (in.)	Shank Diameter (in.)	Head Diameter (in.)	Carton Quantity	Model No.	Replacement for
1½	0.148	0.285	3,000	N10EGPT3000	10d x 1½"
2½			2,500	N10DEGPT2500	10d x 2½"

These products are subject to quantities on hand, or may require special-order, minimum order quantities and longer lead times. Call Simpson Strong-Tie for details.

Connector Nails

Strong-Drive® 33° SCNR RING-SHANK CONNECTOR Nail

Features:

- 33° collation angle
- Full round head

See p. 138 for bulk Strong-Drive® SCNR Ring-Shank Connector Nails.

For Technical Data and Loads, see p. 337

Compatible Pneumatic Tools

If you don't see your particular model in the table below, see strongtie.com/toolmatrix or call Simpson Strong-Tie for assistance with fastener selection (800) 999-5099.

Bostitch®	MCN150 (up to 1½"), MCN250, F33PT
Grip-Rite®	GR150 (up to 1½"), GRSB150-1½ (up to 1½"), GR250, GRSB250-2½
Hitachi®	NR65AK
Paslode®	PF150S-PP (up to 1½"), F250S-PP
Senco®	HN150 (up to 1½"), HN250

Type 316 Stainless Steel

Length (in.)	Shank Diameter (in.)	Head Diameter (in.)	Carton Quantity	Model No.
1½	0.148	⅜	1,500	T9A150MCN
2½	0.148	⅜	1,000	T9A250MCN
1½	0.148	⅜	1,500	T10A150MCN
2½	0.148	⅜	1,000	T10A250MCN

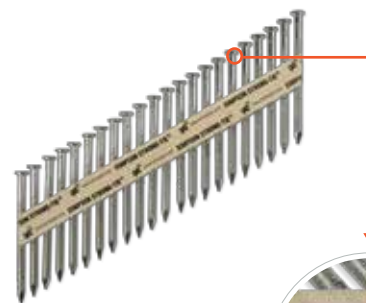

Head Stamp for Easy Identification

Siding/Fencing/Trim Nails

0° Inserted Plastic Coil, Full Round Head, Ring-Shank Nail

Features:

- Checker pattern on head blends with wood grain, reduces glare from sunlight and accepts surface finishes
- Annular ring-shank increases withdrawal resistance to provide a secure attachment
- Available in Type 304 and aluminum

Compatible Pneumatic Tools

If you don't see your particular model in the table below, see strongtie.com/toolmatrix or call Simpson Strong-Tie for assistance with fastener selection (800) 999-5099.

Duo-Fast® KDN50, RCN60, RCN70, CNP-60Y, CNP-65Y, DF225C

Spotnails® QCND65

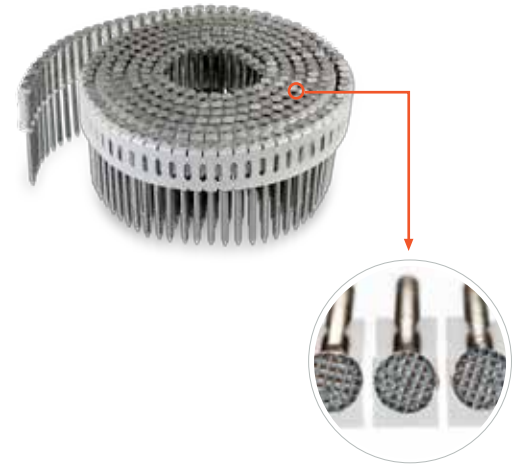

Type 304 Stainless Steel

Penny Size	Length (in.)	Shank Diameter (in.)	Head Diameter (in.)	Carton Quantity	Model No.
7d	2¼	0.099	0.210	7,200	S12A225DNB
7d	2¼	0.099	0.210	1,200	S12A225DNBP

Aluminum

Penny Size	Length (in.)	Shank Diameter (in.)	Head Diameter (in.)	Carton Quantity	Model No.
—	1½	0.099	0.210	9,000	A12A187DNB

These products are subject to quantities on hand, or may require special-order, minimum order quantities and longer lead times. Call Simpson Strong-Tie for details.

Siding/Fencing/Trim Nails

15° Inserted Plastic Coil, Full Round Head, Ring-Shank Nail

Features:

- Checker pattern on head blends with wood grain, reduces glare from sunlight and accepts surface finishes
- Annular ring-shank increases withdrawal resistance to provide a secure attachment
- Choose Type 316 stainless steel for seaside applications and superior corrosion resistance

Compatible Pneumatic Tools

If you don't see your particular model in the table below, see strongtie.com/toolmatrix or call Simpson Strong-Tie for assistance with fastener selection (800) 999-5099.

Bostitch® N64C, N66C, N75C

Grip-Rite® GRTCS250

Hitachi® NV65AH, NV75AG

Max® CN550S (up to 2"), CN565S, CN565

Senco® SCN49



Type 316 Stainless Steel

Penny Size	Length (in.)	Shank Diameter (in.)	Head Diameter (in.)	Carton Quantity	Model No.
4d	1½	0.092	0.221	3,200	T13A150IPC
4d	1½	0.092	0.221	600	T13A150IPBP
5d	1¾	0.092	0.221	3,200	T13A175IPC
5d	1¾	0.092	0.221	600	T13A175IPBP
6d	2	0.092	0.221	3,200	T13A200IPC
6d	2	0.092	0.221	600	T13A200IPBP
7d	2¼	0.092	0.221	2,400	T13A225IPC
7d	2¼	0.092	0.221	600	T13A225IPBP
8d	2½	0.092	0.221	2,400	T13A250IPC
8d	2½	0.092	0.221	600	T13A250IPBP

Type 304 Stainless Steel

Penny Size	Length (in.)	Shank Diameter (in.)	Head Diameter (in.)	Carton Quantity	Model No.
4d	1½	0.092	0.221	3,200	S13A150IPC
5d	1¾	0.092	0.221	3,200	S13A175IPC
6d	2	0.092	0.221	3,200	S13A200IPC
7d	2¼	0.092	0.221	2,400	S13A225IPC
7d	2¼	0.092	0.221	600	S13A225IPBP
8d	2½	0.092	0.221	2,400	S13A250IPC
8d	2½	0.092	0.221	600	S13A250IPBP

Siding/Fencing/Trim Nails

15° Inserted Plastic Coil, White Full Round Head, Ring-Shank Nail

Features:

- Checker pattern on head blends with wood grain, reduces glare from sunlight and accepts surface finishes
- Annular ring-shank increases withdrawal resistance to provide a secure attachment
- Choose Type 316 stainless steel for seaside applications and superior corrosion resistance

Compatible Pneumatic Tools

If you don't see your particular model in the table below, see strongtie.com/toolmatrix or call Simpson Strong-Tie for assistance with fastener selection (800)

Bostitch® N64C, N66C, N75C

Grip-Rite® GRTCS250

Hitachi® NV65AH, NV75AG

Max® CN550S (up to 2"), CN565S, CN565

Senco® SCN49

999-5099.

Type 304 Stainless Steel

Penny Size	Length (in.)	Shank Diameter (in.)	Head Diameter (in.)	Carton Quantity	Model No.
8d	2½	0.092	0.203	600	S13A250IPWBP



White



Type 316 Stainless Steel

Penny Size	Length (in.)	Shank Diameter (in.)	Head Diameter (in.)	Packaging Quantity	Model No.
8d	2½	0.092	0.203	2,400	T8VTN2.4UP

These products are subject to quantities on hand, or may require special-order, minimum order quantities and longer lead times. Call Simpson Strong-Tie for details.

Siding/Fencing/Trim Nails

15° Wire Coil, Full Round Head, Ring-Shank Siding Nail

Features:

- Ideal for use in fiber cement boards
- Checker pattern on heads blends with wood grain, reduces glare from sunlight and accepts surface finishes
- Generous under-head fillet allows nails to be driven flush or countersunk, without crushing surrounding wood
- Annular ring-shank increases withdrawal resistance to provide a secure attachment that reduces cupping of siding boards
- Slender gauge and diamond point for easier driving
- Choose Type 316 stainless steel for seaside applications and superior corrosion resistance

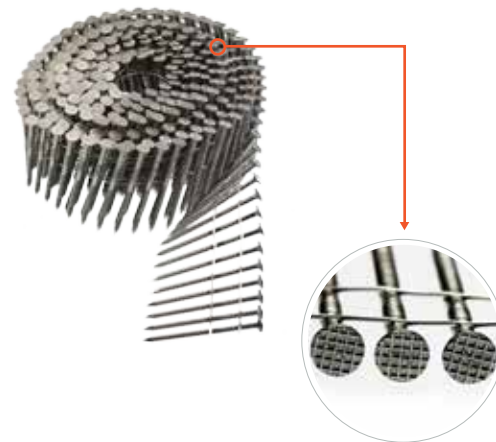

Compatible Pneumatic Tools

If you don't see your particular model in the table below, see strongtie.com/toolmatrix or call Simpson Strong-Tie for assistance with fastener selection (800) 999-5099.

Bostitch®	N64C, N66C, N75C
Duo-Fast®	P275C
Grip-Rite®	GRTCS250
Hitachi®	NV65AH, NV75AG
Max®	CN55, CN665, CN565, CN565S, CN550S (up to 2")
Senco®	SCN60XP, SCN49, SCN 65XP, Pallet Pro57F (up to 2¼")

Type 316 Stainless Steel

Penny Size	Length (in.)	Shank Diameter (in.)	Head Diameter (in.)	Carton Quantity	Model No.
3d	1¼	0.092	0.221	1,800	T13A125SNJ
4d	1¼	0.092	0.221	1,800	T13A125SNJ
4d	1½	0.092	0.221	1,800	T13A150SNJ
5d	1¾	0.092	0.221	1,800	T13A175SNJ
6d	2	0.092	0.221	1,800	T13A200SNJ
7d	2¼	0.092	0.221	1,800	T13A225SNJ
8d	2½	0.092	0.221	1,800	T13A250SNJ

Type 304 Stainless Steel

Penny Size	Length (in.)	Shank Diameter (in.)	Head Diameter (in.)	Carton Quantity	Model No.
3d	1¼	0.092	0.221	3,600	S13A125SNC
3d	1¼	0.092	0.221	1,500	S13A125SNBP
4d	1½	0.092	0.221	3,600	S13A150SNC
4d	1½	0.092	0.221	1,500	S13A150SNBP
5d	1¾	0.092	0.221	3,600	S13A175SNC
5d	1¾	0.092	0.221	1,200	S13A175SNBP
6d	2	0.092	0.221	3,600	S13A200SNC
6d	2	0.092	0.221	1,200	S13A200SNBP
7d	2¼	0.092	0.221	3,600	S13A225SNC
7d	2¼	0.092	0.221	900	S13A225SNBP
8d	2½	0.092	0.221	3,600	S13A250SNC
8d	2½	0.092	0.221	900	S13A250SNBP

These products are subject to quantities on hand, or may require special-order, minimum order quantities and longer lead times. Call Simpson Strong-Tie for details.

Siding/Fencing/Trim Nails

15° Wire Coil, Painted Full Round Head, Ring-Shank Nail

Features:

- Checker pattern on heads blends with wood grain, reduces glare from sunlight and accepts surface finishes
- Durable painted finish helps heads blend with siding material
- Annular ring-shank increases withdrawal resistance to provide a secure attachment that reduces cupping of siding boards
- Slender gauge and diamond point for easier driving

Compatible Pneumatic Tools

If you don't see your particular model in the table below, see strongtie.com/toolmatrix or call Simpson Strong-Tie for assistance with fastener selection (800) 999-5099.

Bostitch®	N64C, N66C, N75C
Duo-Fast®	P275C
Grip-Rite®	GRTCS250
Hitachi®	NV65AH, NV75AG
Max®	CN55, CN665, CN565, CN565S, CN550S (up to 2")
Senco®	SCN60XP, SCN49, SCN 65XP, Pallet Pro57F (up to 2¼")

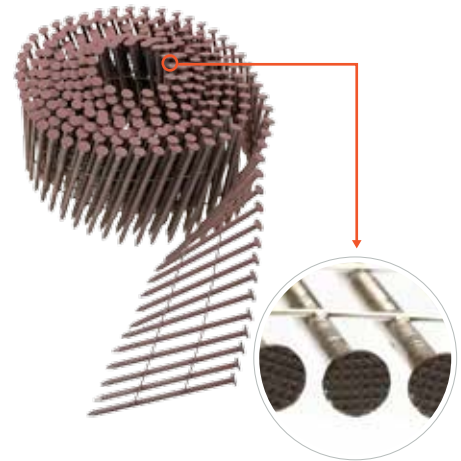

Type 304 Stainless Steel

Penny Size	Length (in.)	Shank Diameter (in.)	Head Diameter (in.)	Color	Carton Quantity	Model No.
6d	2	0.092	0.221	—	1,200	S13A200WWCBP
6d	2	0.092	0.221	Dark Brown	3,600	S13A200CCB
6d	2	0.092	0.221	Gray	3,600	S13A200CCG
6d	2	0.092	0.221	Redwood	3,600	S13A200CCR
6d	2	0.092	0.221	Tan	3,600	S13A200CCT
6d	2	0.092	0.221	White	3,600	S13A200CWH
7d	2¼	0.092	0.221	Dark Brown	3,600	S13A225CCB
7d	2¼	0.092	0.221	White	3,600	S13A225CWH
7d	2¼	0.092	0.221	Gray	3,600	S13A225CCG
7d	2¼	0.092	0.221	Redwood	3,600	S13A225CCR
7d	2¼	0.092	0.221	Tan	3,600	S13A225CCT
7d	2¼	0.092	0.221	Sienna	3,600	S13A225CCS
8d	2½	0.092	0.221	—	900	S13A250WWCBP
8d	2½	0.092	0.221	Dark Brown	900	S13A250CCB
8d	2½	0.092	0.221	Dark Brown	3,600	S13A250CCB
8d	2½	0.092	0.221	Gray	3,600	S13A250CCG
8d	2½	0.092	0.221	Redwood	3,600	S13A250CCR
8d	2½	0.092	0.221	Tan	900	S13A250CCTBP
8d	2½	0.092	0.221	Tan	3,600	S13A250CCT
8d	2½	0.092	0.221	White	3,600	S13A250CWH
8d	2½	0.092	0.221	Sienna	900	S13A250CCSBP
8d	2½	0.092	0.221	Sienna	3,600	S13A250CCS



These products are subject to quantities on hand, or may require special-order, minimum order quantities and longer lead times. Call Simpson Strong-Tie for details.

Roofing Nails

15° Wire Coil, Full Round Head, Ring-Shank Roofing Nail

Features:

- Ideal for asphalt and synthetic slate roofing
- Large flat head, diamond point for easier driving
- Annular ring-shank increases withdrawal resistance to provide a secure attachment to OSB or plywood roof decks
- Choose Type 316 stainless steel for seaside applications and superior corrosion resistance

Compatible Pneumatic Tools

If you don't see your particular model in the table below, see strongtie.com/toolmatrix or call Simpson Strong-Tie for assistance with fastener selection (800) 999-5099.

Bosch®	RN175
Bostitch®	RN46
DeWalt®	D51321
Grip-Rite®	GRTCR175
Hitachi®	NV45AB2, NV45AE
Makita®	AN453
Max®	CN445R, CN450R
Paslode®	R175-C, CR175C
Porter Cable®	RN175A
Ridgid®	R175RND
Senco®	RoofPro 455XP

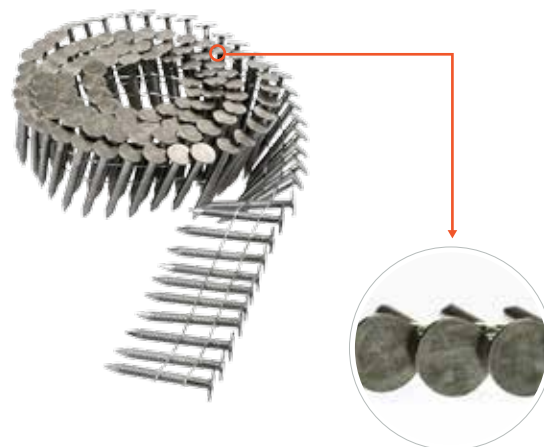

Type 316 Stainless Steel

Penny Size	Length (in.)	Shank Diameter (in.)	Head Diameter (in.)	Carton Quantity	Model No.
2d	1	0.120	3/8	3,600	T11A100RNJ
3d	1¼	0.120	3/8	3,600	T11A125RNJ
4d	1½	0.120	3/8	3,600	T11A150RNJ
5d	1¾	0.120	3/8	3,600	T11A175RNJ

Type 304 Stainless Steel

Penny Size	Length (in.)	Shank Diameter (in.)	Head Diameter (in.)	Carton Quantity	Model No.
2d	1	0.120	3/8	7,200	S11A100RNB
3d	1¼	0.120	3/8	7,200	S11A125RNB
3d	1¼	0.120	3/8	720	S11A125RNBP
3d	1¼	0.120	3/8	2,400	S11A125RNJ
4d	1½	0.120	3/8	7,200	S11A150RNB
4d	1½	0.120	3/8	600	S11A150RNBP
4d	1½	0.120	3/8	2,400	S11A150RNJ
5d	1¾	0.120	3/8	7,200	S11A175RNB
5d	1¾	0.120	3/8	480	S11A175RNBP
5d	1¾	0.120	3/8	2,400	S11A175RNJ

These products are subject to quantities on hand, or may require special-order, minimum order quantities and longer lead times. Call Simpson Strong-Tie for details.

Roofing Nails

15° Wire Coil, Full Round Head, Smooth-Shank Roofing Nail

Features:

- Ideal for asphalt and synthetic slate roofing
- Large flat head, diamond point for easier driving
- Annular ring-shank increases withdrawal resistance to provide a secure attachment to OSB or plywood roof decks
- Choose Type 316 stainless steel for seaside applications and superior corrosion resistance

Compatible Pneumatic Tools

If you don't see your particular model in the table below, see strongtie.com/toolmatrix or call Simpson Strong-Tie for assistance with fastener selection (800) 999-5099.

Bosch®	RN175
Bostitch®	RN46
DeWalt®	D51321
Grip-Rite®	GRTCR175
Hitachi®	NV45AB2, NV45AE
Makita®	AN453
Max®	CN445R, CN450R
Paslode®	R175-C, CR175C
Porter Cable®	RN175A
Ridgid®	R175RND
Senco®	RoofPro 455XP

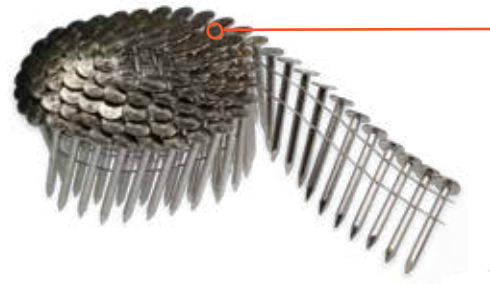

Type 316 Stainless Steel

Penny Size	Length (in.)	Shank Diameter (in.)	Head Diameter (in.)	Carton Quantity	Model No.
4d	1½	0.120	¾	3,600	T11N150RNJ
5d	1¾	0.120	¾	3,600	T11N175RNJ

Type 304 Stainless Steel

Penny Size	Length (in.)	Shank Diameter (in.)	Head Diameter (in.)	Carton Quantity	Model No.
—	¾	0.120	¾	7,200	S11N075RNB
—	7⁄8	0.120	¾	7,200	S11N087RNB
2d	1	0.120	¾	7,200	S11N100RNB
2d	1	0.120	¾	2,400	S11N100RNJ
3d	1¼	0.120	¾	7,200	S11N125RNB
3d	1¼	0.120	¾	2,400	S11N125RNJ
4d	1½	0.120	¾	7,200	S11N150RNB
4d	1½	0.120	¾	2,400	S11N150RNJ
5d	1¾	0.120	¾	7,200	S11N175RNB
5d	1¾	0.120	¾	2,400	S11N175RNJ

These products are subject to quantities on hand, or may require special-order, minimum order quantities and longer lead times. Call Simpson Strong-Tie for details.

Framing Nails – Wire Coil

15° Wire Coil, Full Round Head, Ring-Shank Decking/Framing Nail

Features:

- Checker pattern on head blends with wood grain, reduces glare from sunlight and accepts surface finishes
- Annular ring-shank increases withdrawal resistance to provide a secure attachment
- Choose Type 316 stainless steel for seaside applications and superior corrosion resistance

Compatible Pneumatic Tools

If you don't see your particular model in the table below, see strongtie.com/toolmatrix or call Simpson Strong-Tie for assistance with fastener selection (800) 999-5099.

Bostitch®	N80CB (up to 3¼"), N75C (up to 3"), N89C
DeWalt®	D51855
Duo-Fast®	P350C/CNW90, P275C (up to 2¾")
Grip-Rite®	GRTC90-3½, GRTCS250 (up to 0.099", 2½")
Hitachi®	NV65AH (up to 0.099", 2½"), NV75AG (up to 3"), NV83A2
Makita®	AN901
Max®	CN565S (up to 2½", 0.099"), CN565D (up to 2½", 0.113"), CN665 (up to 2½"), CN890S, CN565 (up to 2½", 0.099"), CN100, CN70 (up to 2½"), CN80 (up to 3¼")
Senco®	SCN60XP (up to 2¾", 0.113"), SCN49 (up to 2½", 0.113"), SCN 65XP (up to 0.113"), PalletPro100, PalletPro130 (over 3"), PalletPro70 (up to 2¾", 0.113"), PalletPro83 (up to 3¼")



Type 316 Stainless Steel

Penny Size	Length (in.)	Shank Diameter (in.)	Head Diameter (in.)	Carton Quantity	Carton Weight (lb.)	Model No.
6d	2	0.113	¼	3,600	21	T12A200PNB
7d	2¼	0.099	¼	1,800	10	T12A225PNJ
8d	2½	0.099	¼	1,800	10	T12A250PNJ
8d	2½	0.099	¼	3,600	31	T12A250PNB
10d	3	0.120	17/64	1,800	19	T11A300PNJ
10d	3	0.131	9/32	1,800	24	T10A300PNJ
12d	3¼	0.120	17/64	1,800	20	T11A325PNJ
16d	3½	0.131	9/32	1,800	28	T10A350PNJ

Type 304 Stainless Steel

Penny Size	Length (in.)	Shank Diameter (in.)	Head Diameter (in.)	Carton Quantity	Carton Weight (lb.)	Model No.
4d	1½	0.099	¼	3,600	14	S12A150PNB
5d	1¾	0.099	¼	3,600	15	S12A175PNB
6d	2	0.099	¼	3,600	17	S12A200PNB
8d	2½	0.099	¼	3,600	21	S12A250PNB
8d	2¾	0.113	¼	3,600	26	S12A237PNB
10d	3	0.120	17/64	1,800	19	S11A300PNJ
10d	3	0.131	9/32	1,800	24	S10A300PNJ
12d	3¼	0.120	17/64	1,800	20	S11A325PNJ
12d	3¼	0.131	9/32	1,800	26	S10A325PNJ

These products are subject to quantities on hand, or may require special-order, minimum order quantities and longer lead times. Call Simpson Strong-Tie for details.

Framing Nails – Wire Coil

15° Wire Coil, Painted Full Round Head, Ring-Shank Decking/Framing Nail

Features:

- Checker pattern on head blends with the wood grain, reduces glare from sunlight and accepts surface finishes
- Annular ring-shank increases withdrawal resistance to provide a secure attachment

Compatible Pneumatic Tools

If you don't see your particular model in the table below, see strongtie.com/toolmatrix or call Simpson Strong-Tie for assistance with fastener selection (800) 999-5099.

Bostitch®	N80CB (up to 3¼"), N75C (up to 3"), N89C
DeWalt®	D51855
Duo-Fast®	P350C/CNW90, P275C (up to 2¾")
Grip-Rite®	GRTC90-3½, GRTCS250 (up to 0.099", 2½")
Hitachi®	NV65AH (up to 0.099", 2½"), NV75AG (up to 3"), NV83A2
Makita®	AN901
Max®	CN565S (up to 2½", 0.099"), CN565D (up to 2½", 0.113"), CN665 (up to 2½"), CN890S, CN565 (up to 2½", 0.099"), CN100, CN70 (up to 2½"), CN80 (up to 3¼")
Senco®	SCN60XP (up to 2¾", 0.113"), SCN49 (up to 2½", 0.113"), SCN 65XP (up to 0.113"), PalletPro100, PalletPro130 (over 3"), PalletPro70 (up to 2¾", 0.113"), PalletPro83 (up to 3¼")



Type 304 Stainless Steel

Penny Size	Length (in.)	Shank Diameter (in.)	Head Diameter (in.)	Color	Carton Quantity	Model No.
10d	3	0.120	17/64	Dark Brown	1,800	S11A300PJB
10d	3	0.120	17/64	Gray	1,800	S11A300PJG
10d	3	0.120	17/64	Redwood	1,800	S11A300PJR
10d	3	0.120	17/64	Tan	1,800	S11A300PJT
10d	3	0.120	17/64	Sienna	1,800	S11A300PJS
12d	3¼	0.120	17/64	Dark Brown	1,800	S11A325PJB
12d	3¼	0.120	17/64	Gray	1,800	S11A325PJG
12d	3¼	0.120	17/64	Redwood	1,800	S11A325PJR
12d	3¼	0.120	17/64	Tan	1,800	S11A325PJT



Framing Nails – Plastic Strip

20°–22° Plastic Strip, Casing Head, Ring-Shank Nail

Features:

- Countersunk casing head
- Durable painted finish helps head blend with decking and siding material
- Checker pattern on head blends with wood grain
- Annular ring-shank increases withdrawal resistance to provide a secure attachment

Compatible Pneumatic Tools

If you don't see your particular model in the table below, see strongtie.com/toolmatrix or call Simpson Strong-Tie for assistance with fastener selection (800) 999-5099.

Bosch®	SN350-20F (up to 0.148")
Bostitch®	F21PL
DeWalt®	D51850 (up to 0.148"), D51844 (up to 0.148")
Grip-Rite®	GRTRFR83 (up to 0.131", 3/4"), GRTRH350 (up to 0.148")
Hitachi®	NR83AS (up to 0.131", 3/4"), NR90AC3, NR90AEPR (up to 0.148"), NR90GR (up to 0.131"), NR90GR2 (up to 0.131")
Makita®	AN923
Max®	SN883RH (up to 0.148", 3/4"), SN883RH2 (up to 0.148", 3/4") SN890RH (up to 0.148")
Porter Cable®	FR350MAG, FR350A (up to 0.148")
Ridgid®	R350RHA
Senco®	SN902XP (up to 0.148", 3/4"), SN952XP (up to 0.148"), GT90FRH (up to 0.131"), FramePro 602 (up to 0.148"), FramePro 702XP (up to 0.148"), FramePro 752XP

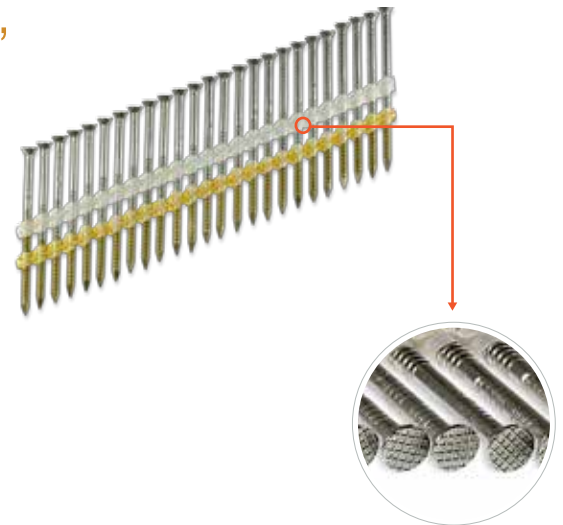

Type 304 Stainless Steel

Penny Size	Length (in.)	Shank Diameter (in.)	Head Diameter (in.)	Color	Carton Quantity	Model No.
8d	2 3/8	0.120	1/4	None	1,000	S11A237KDJ
8d	2 3/8	0.120	1/4	Dark Brown	1,000	S11A237KJB
8d	2 3/8	0.120	1/4	Gray	1,000	S11A237KJG
8d	2 3/8	0.120	1/4	Redwood	1,000	S11A237KJR
8d	2 3/8	0.120	1/4	Sienna	1,000	S11A237KJS
8d	2 3/8	0.120	1/4	Tan	1,000	S11A237KJT
12d	3 1/4	0.131	1/4	None	1,000	S10A325KDJ
12d	3 1/4	0.131	1/4	Dark Brown	1,000	S10A325KJB
12d	3 1/4	0.131	1/4	Gray	1,000	S10A325KJG
12d	3 1/4	0.131	1/4	Redwood	1,000	S10A325KJR
12d	3 1/4	0.131	1/4	Sienna	1,000	S10A325KJS
12d	3 1/4	0.131	1/4	Tan	1,000	S10A325KJT



C-F-2017 © 2017 SIMPSON STRONG-TIE COMPANY INC.

Collated Nails and Staples

Framing Nails – Plastic Strip

20°–22° Plastic Strip, Full Round Head, Ring-Shank Nail

Features:

- Checker pattern on head blends with the wood grain, reduces glare from sunlight and accepts surface finishes
- Annular ring-shank increases withdrawal resistance to provide a secure attachment
- Choose Type 316 stainless steel for seaside applications and superior corrosion resistance
- 2⅝" or longer have painted tips

Compatible Pneumatic Tools

If you don't see your particular model in the table below, see strongtie.com/toolmatrix or call Simpson Strong-Tie for assistance with fastener selection (800) 999-5099.

Bosch®	SN350-20F (up to 0.148")	Makita®	AN923
Bostitch®	F21PL	Max®	SN883RH (up to 0.148", 3¼"), SN883RH2 (up to 0.148", 3¼") SN890RH (up to 0.148")
DeWalt®	D51850 (up to 0.148"), D51844 (up to 0.148")	Porter Cable®	FR350MAG, FR350A (up to 0.148")
Grip-Rite®	GRTFR83 (up to 0.131", 3¼"), GRTRH350 (up to 0.148")	Ridgid®	R350RHA
Hitachi®	NR83AS (up to 0.131", 3¼"), NR90AC3, NR90AEPR (up to 0.148"), NR90GR (up to 0.131"), NR90GR2 (up to 0.131")	Senco®	SN902XP (up to 0.148", 3¼"), SN952XP (up to 0.148"), GT90FRH (up to 0.131") FramePro 602 (up to 0.148"), FramePro 702XP (up to 0.148"), FramePro 752XP

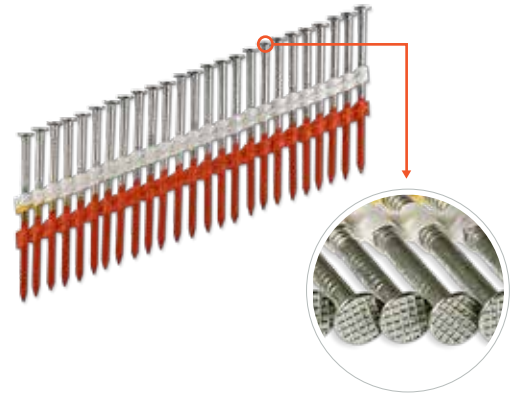

Type 316 Stainless Steel

Penny Size	Length (in.)	Shank Diameter (in.)	Head Diameter (in.)	Carton Quantity	Model No.
6d	2	0.113	⅝	5,000	T12A200CNB
6d	2	0.113	⅝	1,000	T12A200CNJ
8d	2⅝	0.113	⅝	5,000	T12A237CNB
8d	2⅝	0.113	⅝	1,000	T12A237CNJ
8d	2½	0.120	⅝	4,000	T11A250CNB
8d	2½	0.120	⅝	1,000	T11A250CNJ
10d	3	0.120	⅝	4,000	T11A300CNB
10d	3	0.120	⅝	1,000	T11A300CNJ
10d	3	0.131	⅝	4,000	T10A300CNB
10d	3	0.131	⅝	1,000	T10A300CNJ
12d	3¼	0.120	⅝	4,000	T11A325CNB
12d	3¼	0.120	⅝	1,000	T11A325CNJ
12d	3¼	0.131	⅝	4,000	T10A325CNB
12d	3¼	0.131	⅝	1,000	T10A325CNJ
16d	3½	0.131	⅝	4,000	T10A350CNB
16d	3½	0.131	⅝	1,000	T10A350CNJ

Type 304 Stainless Steel

Penny Size	Length (in.)	Shank Diameter (in.)	Head Diameter (in.)	Carton Quantity	Model No.
6d	2	0.113	⅝	5,000	S12A200CNB
6d	2	0.113	⅝	1,000	S12A200CNJ
6d	2	0.120	⅝	5,000	S11A200CNB
6d	2	0.120	⅝	1,000	S11A200CNJ
7d	2¼	0.148	⅝	1,000	S9A225CNJ
8d	2⅝	0.113	⅝	5,000	S12A237CNB
8d	2⅝	0.113	⅝	1,000	S12A237CNJ
8d	2½	0.120	⅝	4,000	S11A250CNB
8d	2½	0.120	⅝	1,000	S11A250CNJ
8d	2½	0.131	⅝	4,000	S10A250CNB
10d	3	0.120	⅝	4,000	S11A300CNB
10d	3	0.120	⅝	1,000	S11A300CNJ
10d	3	0.131	⅝	4,000	S10A300CNB
10d	3	0.131	⅝	1,000	S10A300CNJ
12d	3¼	0.120	⅝	4,000	S11A325CNB
12d	3¼	0.120	⅝	1,000	S11A325CNJ
12d	3¼	0.131	⅝	4,000	S10A325CNB
12d	3¼	0.131	⅝	1,000	S10A325CNJ
16d	3½	0.131	⅝	4,000	S10A350CNB
16d	3½	0.131	⅝	1,000	S10A350CNJ

These products are subject to quantities on hand, or may require special-order, minimum order quantities and longer lead times. Call Simpson Strong-Tie for details.

Framing Nails – Plastic Strip

20°–22° Plastic Strip, Full Round Head, Screw-Shank Nail

Features:

- Smooth head
- Screw shank increases withdrawal resistance to provide a secure attachment
- Choose Type 316 stainless steel for seaside applications and superior corrosion resistance
- 2½" or longer have painted tips

Compatible Pneumatic Tools

If you don't see your particular model in the table below, see strongtie.com/toolmatrix or call Simpson Strong-Tie for assistance with fastener selection (800) 999-5099.

Bosch®	SN350-20F (up to 0.148")
Bostitch®	F21PL
DeWalt®	D51850 (up to 0.148"), D51844 (up to 0.148")
Grip-Rite®	GRTRFR83 (up to 0.131", 3¼"), GRTRH350 (up to 0.148")
Hitachi®	NR83AS (up to 0.131", 3¼"), NR90AC3, NR90AEPR (up to 0.148"), NR90GR (up to 0.131"), NR90GR2 (up to 0.131")
Makita®	AN923
Max®	SN883RH (up to 0.148", 3¼"), SN883RH2 (up to 0.148", 3¼"), SN890RH (up to 0.148")
Porter Cable®	FR350MAG, FR350A (up to 0.148")
Ridgid®	R350RHA
Senco®	SN902XP (up to 0.148", 3¼"), SN952XP (up to 0.148"), GT90FRH (up to 0.131"), FramePro 602 (up to 0.148"), FramePro 702XP (up to 0.148"), FramePro 752XP

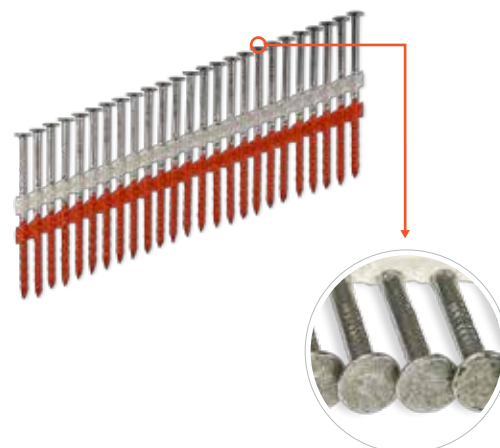

Type 316 Stainless Steel

Penny Size	Length (in.)	Shank Diameter (in.)	Head Diameter (in.)	Carton Quantity	Model No.
6d	2	0.113	9/32	5,000	T12S200CNB
6d	2	0.113	9/32	1,000	T12S200CNJ
8d	2½	0.113	9/32	4,000	T12S250CNB
8d	2½	0.113	9/32	1,000	T12S250CNJ
10d	3	0.120	9/32	4,000	T11S300CNB
10d	3	0.120	9/32	1,000	T11S300CNJ
10d	4	0.131	9/32	1,000	T10S300CNJ
12d	3¼	0.120	9/32	4,000	T11S325CNB
12d	3¼	0.120	9/32	1,000	T11S325CNJ
16d	3½	0.131	9/32	4,000	T10S350CNB
16d	3½	0.131	9/32	1,000	T10S350CNJ

Type 304 Stainless Steel

Penny Size	Length (in.)	Shank Diameter (in.)	Head Diameter (in.)	Carton Quantity	Model No.
6d	2	0.113	9/32	5,000	S12S200CNB
6d	2	0.113	9/32	1,000	S12S200CNJ
8d	2½	0.113	9/32	4,000	S12S250CNB
8d	2½	0.113	9/32	1,000	S12S250CNJ
10d	3	0.120	9/32	4,000	S11S300CNB
10d	3	0.120	9/32	1,000	S11S300CNJ
12d	3¼	0.120	9/32	4,000	S11S325CNB
12d	3¼	0.120	9/32	1,000	S11S325CNJ
16d	3½	0.131	9/32	4,000	S10S350CNB
16d	3½	0.131	9/32	1,000	S10S350CNJ

These products are subject to quantities on hand, or may require special-order, minimum order quantities and longer lead times. Call Simpson Strong-Tie for details.

Framing Nails – Plastic Strip

20°–22° Plastic Strip, Full Round Head, Smooth-Shank Nail

Features:

- Smooth head
- Choose Type 316 stainless steel for seaside applications and superior corrosion resistance
- 2½" or longer have painted tips

Compatible Pneumatic Tools

If you don't see your particular model in the table below, see strongtie.com/toolmatrix or call Simpson Strong-Tie for assistance with fastener selection (800) 999-5099.

Bosch®	SN350-20F (up to 0.148")
Bostitch®	F21PL
DeWalt®	D51850 (up to 0.148"), D51844 (up to 0.148")
Grip-Rite®	GRTRFR83 (up to 0.131", 3¼"), GRTRH350 (up to 0.148")
Hitachi®	NR83AS (up to 0.131", 3¼"), NR90AC3, NR90AEPR (up to 0.148"), NR90GR (up to 0.131"), NR90GR2 (up to 0.131")
Makita®	AN923
Max®	SN883RH (up to 0.148", 3¼"), SN883RH2 (up to 0.148", 3¼"), SN890RH (up to 0.148")
Porter Cable®	FR350MAG, FR350A (up to 0.148")
Ridgid®	R350RHA
Senco®	SN902XP (up to 0.148", 3¼"), SN952XP (up to 0.148"), GT90FRH (up to 0.131"), FramePro 602 (up to 0.148"), FramePro 702XP (up to 0.148"), FramePro 752XP

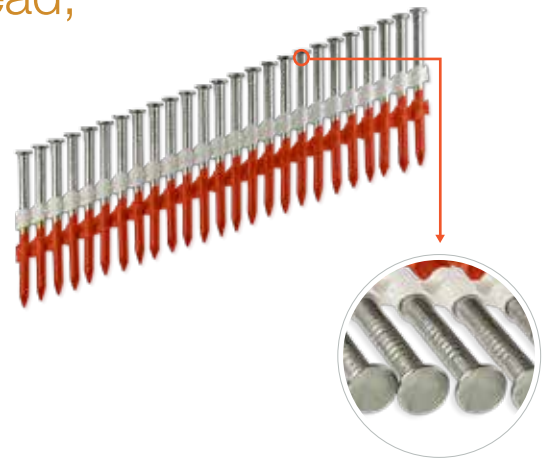

Type 304 Stainless Steel

Penny Size	Length (in.)	Shank Diameter (in.)	Head Diameter (in.)	Carton Quantity	Model No.
8d	2½	0.113	⅝	5,000	S12N237CNB
8d	2½	0.113	⅝	1,000	S12N237CNJ
10d	3	0.148	⅝	1,000	S9N300CNJ
16d	3½	0.162	⅝	1,000	S8N350CNJ

These products are subject to quantities on hand, or may require special-order, minimum order quantities and longer lead times. Call Simpson Strong-Tie for details.

Framing Nails – Plastic Strip

31°–34° Plastic Strip, Full Round Head, Ring-Shank Nail

Features:

- Checker pattern on head blends with wood grain, reduces glare from sunlight and accepts surface finishes
- Annular ring-shank increases withdrawal resistance to provide a secure attachment
- Choose Type 316 stainless steel for seaside applications and superior corrosion resistance

Compatible Pneumatic Tools

If you don't see your particular model in the table below, see strongtie.com/toolmatrix or call Simpson Strong-Tie for assistance with fastener selection (800) 999-5099.

Bosch®	SN350-34C
Bostitch®	F33PT
DeWalt®	D51825, D51822
Grip-Rite®	GRTFC83 (up to 3¼"), GRTCH350
Hitachi®	NR83AA3 (up to 3¼"), NR90ADPR, NR90GC2
Makita®	AN943
Max®	SN883CH/34 (up to 3¼"), SN890CH/34
Paslode®	PF350S, CF325 (up to 3¼"), F350S, 900420 (up to 3¼")
Porter Cable®	FC350A
Ridgid®	R350CHA
Senco®	SN901XP (up to 3¼"), SN951XP, GT90CH, FramePro601, FramePro701XP

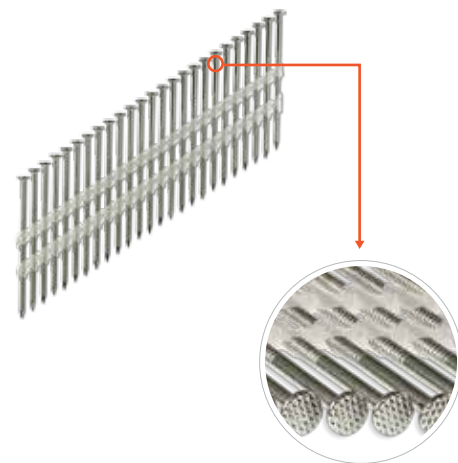

Type 316 Stainless Steel

Penny Size	Length (in.)	Shank Diameter (in.)	Head Diameter (in.)	Carton Quantity	Model No.
8d	2¾	0.113	⅝	4,000	T12A237B31

Type 304 Stainless Steel

Penny Size	Length (in.)	Shank Diameter (in.)	Head Diameter (in.)	Carton Quantity	Model No.
8d	2¾	0.113	⅝	4,000	S12A237B31
8d	2¾	0.113	⅝	1,000	S12A237P31
10d	3	0.120	⅝	4,000	S11A300B31
10d	3	0.120	⅝	1,000	S11A300P31

Framing Nails – Wire Weld

28° Wire-Weld, Clipped Head, Ring-Shank Nail

Features:

- Smooth head
- Annular ring-shank increases withdrawal resistance to provide a secure attachment

Compatible Pneumatic Tools

If you don't see your particular model in the table below, see strongtie.com/toolmatrix or call Simpson Strong-Tie for assistance with fastener selection (800) 999-5099.

Bostitch® F28WW, GF28WW, N100S

Grip-Rite® GRTFW83

Hitachi® NR90AF

Max® SN883CH/28, SN890CH/28

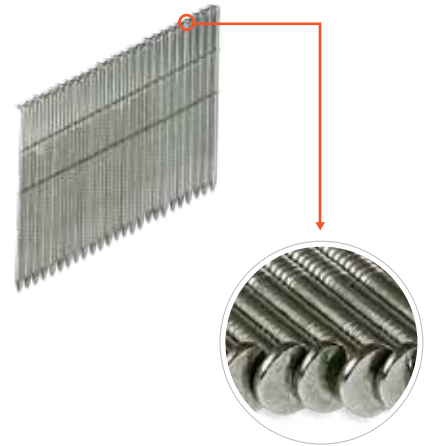

Type 304 Stainless Steel

Penny Size	Length (in.)	Shank Diameter (in.)	Carton Quantity	Model No.
8d	2¾	0.113	1,000	S12A237W28
10d	3	0.120	1,000	S11A300W28
12d	3¼	0.131	1,000	S10A325W28

Framing Nails – Paper Tape

31°–34° Paper Tape, Clipped Head, Ring-Shank Nail

Features:

- Smooth head
- Annular ring-shank increases withdrawal resistance to provide a secure attachment
- Choose Type 316 stainless steel for seaside applications and superior corrosion resistance

Compatible Pneumatic Tools

If you don't see your particular model in the table below, see strongtie.com/toolmatrix or call Simpson Strong-Tie for assistance with fastener selection (800) 999-5099.

Bosch®	SN350-34C
Bostitch®	F33PT
DeWalt®	D51825, D51822
Grip-Rite®	GRTFC83 (up to 3¼"), GRTCH350
Hitachi®	NR83AA3 (up to 3¼"), NR90ADPR, NR90GC2
Makita®	AN943
Max®	SN883CH/34 (up to 3¼"), SN890CH/34
Paslode®	PF350S, CF325 (up to 3¼"), F350S, 900420 (up to 3¼")
Porter Cable®	FC350A
Ridgid®	R350CHA
Senco®	SN901XP (up to 3¼"), SN951XP, GT90CH, FramePro601, FramePro701XP

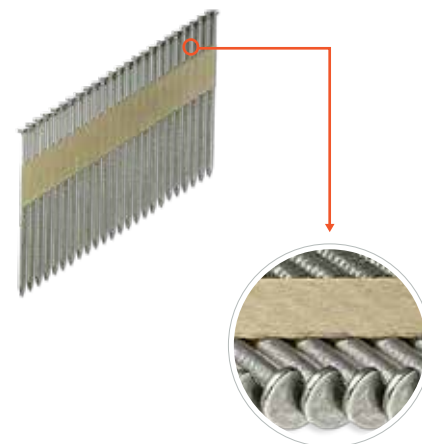

Type 316 Stainless Steel

Penny Size	Length (in.)	Shank Diameter (in.)	Carton Quantity	Model No.
8d	2¾	0.113	1,000	T12A237T31
10d	3	0.120	1,000	T11A300T31
12d	3¼	0.131	1,000	T10A325T31

Type 304 Stainless Steel

Penny Size	Length (in.)	Shank Diameter (in.)	Carton Quantity	Model No.
6d	2	0.113	1,000	S12A200T31
8d	2¾	0.113	1,000	S12A237T31
10d	3	0.120	1,000	S11A300T31
12d	3¼	0.131	1,000	S10A325T31
16d	3½	0.131	1,000	S10A350T31

These products are subject to quantities on hand, or may require special-order, minimum order quantities and longer lead times. Call Simpson Strong-Tie for details.

Trim Nails

20° Angle, Adhesive Collation, T-Style Head, 16-Gauge Finishing Nail

Features:

- T-style head minimizes nail head size for easier concealment
- Choose Type 316 stainless steel for seaside applications and superior corrosion resistance

Compatible Pneumatic Tools

If you don't see your particular model in the table below, see strongtie.com/toolmatrix or call Simpson Strong-Tie for assistance with fastener selection (800) 999-5099.

DeWalt® DC618K

Duo-Fast® FloorMaster 2505N

Hitachi® NT65GB

Paslode® 900600, T250A-F16

Senco® GT65RHA



Type 316 Stainless Steel

Penny Size	Length (in.)	500-Count Model No.	2,000-Count Model No.
4d	1½	T16N150PFB	T16N150PFN
6d	2	T16N200PFB	T16N200PFN
8d	2½	T16N250PFB	T16N250PFN

Type 304 Stainless Steel

Penny Size	Length (in.)	500-Count Model No.	2,000-Count Model No.
4d	1½	S16N150PFB	S16N150PFN
6d	2	S16N200PFB	S16N200PFN
8d	2½	S16N250PFB	S16N250PFN

25° Angle, Adhesive Collation, FN-Style, 15-Gauge Finishing Nail

Features:

- T-style head minimizes nail head size for easier concealment
- Choose Type 316 stainless steel for seaside applications and superior corrosion resistance

Compatible Pneumatic Tools

If you don't see your particular model in the table below, see strongtie.com/toolmatrix or call Simpson Strong-Tie for assistance with fastener selection (800) 999-5099.

Bostitch® N62FNK-2, GFN1546K

Makita® AF632, AF631



Type 316 Stainless Steel

Penny Size	Length (in.)	500-Count Model No.	3,500-Count Model No.
4d	1½	T15N150FNB	T15N150FNJ
6d	2	T15N200FNB	T15N200FNJ
8d	2½	T15N250FNB	T15N250FNJ

Type 304 Stainless Steel

Penny Size	Length (in.)	500-Count Model No.	3,500-Count Model No.
4d	1½	S15N150FNB	S15N150FNJ
6d	2	S15N200FNB	S15N200FNJ
8d	2½	S15N250FNB	S15N250FNJ

These products are subject to quantities on hand, or may require special-order, minimum order quantities and longer lead times. Call Simpson Strong-Tie for details.

Trim Nails

Straight, Adhesive Collation, T-Style Head, 16-Gauge Finishing Nail

Choose Type 316 stainless steel for seaside applications and superior corrosion resistance

Compatible Pneumatic Tools

If you don't see your particular model in the table below, see strongtie.com/toolmatrix or call Simpson Strong-Tie for assistance with fastener selection (800) 999-5099.



Bosch®	FNS250-16
Bostitch®	FN1664K, SB-1664FN, GFN1664K
DeWalt®	DC616K, D51257K
Duo-Fast®	FloorMaster 200-C, SureShot764 (up to 2")
Grip-Rite®	GRTFN250
Hitachi®	NT65A3, NT6GS, NT65M2
Max®	NF352-ST/16-50 (up to 2")
Paslode®	T250S-F16, 902000
Porter Cable®	FN250C
Ridgid®	R250SFA
Senco®	FinishPro32

Type 316 Stainless Steel

Length (in.)	500-Count Model No.	2,500-Count Model No.
1¼	T16N125FNB	T16N125FNJ
1½	T16N150FNB	T16N150FNJ
2	T16N200FNB	T16N200FNJ
2½	T16N250FNB	T16N250FNJ

Type 304 Stainless Steel

Length (in.)	500-Count Model No.	2,500-Count Model No.
1½	S16N150FNB	S16N150FNJ
2	S16N200FNB	S16N200FNJ
2½	S16N250FNB	S16N250FNJ

Trim Nails

Straight, Adhesive Collation, T-Style Head, 18-Gauge Brads

Choose Type 316 stainless steel for seaside applications and superior corrosion resistance

Compatible Pneumatic Tools

If you don't see your particular model in the table below, see strongtie.com/toolmatrix or call Simpson Strong-Tie for assistance with fastener selection (800) 999-5099.

Bosch®	BNS200-18
Bostitch®	BT1855K, SB-1850BN, SB-2IN1 (up to 1½"), GBT1850K
DeWalt®	DC51236K (up to 1¼"), D51238K
Duo-Fast®	SureShot 2232 (up to 1"), SureShot 4450 (up to 1½"), SureShot 4450 ST (up to 1½")
Grip-Rite®	GRTBN125 (up to 1¼"), GRTBN200
Hitachi®	NT32AE2 (up to 1¼"), NT50AE2, NT50GS
Makita®	AF505
Max®	NF235F/18 (up to 1¼"), NF201/18-35 (up to 1¼"), NF255-ST/18
Paslode®	T200-F18, 901000
Porter Cable®	BN138 (up to 1¼"), BN200B
Ridgid®	R213BNA
Senco®	SLP20XP (up to 1½"), FinishPro25XP



Type 316 Stainless Steel

Length (in.)	500-Count Model No.	Carton Quantity	Model No.
¾	—	10,000	T18N037FNJ
1½	—	5,000	T18N050FNJ
5/8	—	5,000	T18N062FNJ
¾	T18N075FNB	5,000	T18N075FNJ
1	T18N100FNB	5,000	T18N100FNJ
1¼	T18N125FNB	5,000	T18N125FNJ
1½	T18N150FNB	5,000	T18N150FNJ
1¾	—	5,000	T18N175FNJ
2	T18N200FNB	5,000	T18N200FNJ

Type 304 Stainless Steel

Length (in.)	500-Count Model No.	Carton Quantity	Model No.
¾	S18N075FNB	5,000	S18N075FNJ
1	S18N100FNB	5,000	S18N100FNJ
1¼	S18N125FNB	5,000	S18N125FNJ
1½	S18N150FNB	5,000	S18N150FNJ
1¾	—	5,000	S18N175FNJ
2	S18N200FNB	5,000	S18N200FNJ

These products are subject to quantities on hand, or may require special-order, minimum order quantities and longer lead times. Call Simpson Strong-Tie for details.

Trim Nails

Straight, Adhesive Collation, 23-Gauge Micro Pins

Features:

- Headless micro pins
- Smooth shank

Compatible Pneumatic Tools

If you don't see your particular model in the table below, see strongtie.com/toolmatrix or call Simpson Strong-Tie for assistance with fastener selection (800) 999-5099.

Bostitch®	HP118K
Duo-Fast®	SureShot 2236
Grip-Rite®	GRTPIN23
Hitachi®	NP35A
Max®	NF235A/23-35
Porter Cable®	PIN100 (up to 1"), PIN138
Ridgid®	R138HPA
Senco®	FinishPro11



Type 304 Stainless Steel

Gauge	Length (in.)	Carton Count	Model No.
23	½	1,000	S23N050MPB
23	½	5,000	S23N050MPN
23	¾	1,000	S23N075MPB
23	¾	5,000	S23N075MPN
23	1	1,000	S23N100MPB
23	1	5,000	S23N100MPN
23	1 ¼	1,000	S23N119MPB
23	1 ¼	5,000	S23N119MPN
23	1 ½	1,000	S23N150MPB
23	1 ½	5,000	S23N150MPN
23	1 ¾	1,000	S23N175MPB
23	1 ¾	5,000	S23N175MPN

Trim Nails

Tape Collation, DA-Style Angle, 15-Gauge Finishing Nail

Features:

- D-style head has greater bearing area to draw trim to the substrate
- Choose Type 316 stainless steel for seaside applications and superior corrosion resistance

Compatible Pneumatic Tools

If you don't see your particular model in the table below, see strongtie.com/toolmatrix or call Simpson Strong-Tie for assistance with fastener selection (800) 999-5099.

Bosch®	FNA250-15
DeWalt®	DC628K, D51276K
Grip-Rite®	GRTAN250
Hitachi®	NT65GA, NT65MA4
Makita®	AF633
Max®	NF550/15-65
Porter Cable®	DA250C
Ridgid®	R250AFA, R250AF18
Senco®	Fusion F15, GT65DA, FinishPro42XP

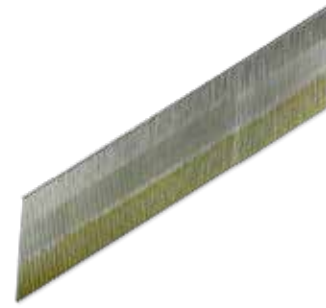

Type 316 Stainless Steel

Penny Size	Length (in.)	500-Count Model No.	4,000-Count Model No.
3d	1 ¼	—	T15N125SFN
4d	1 ½	T15N150SFB	T15N150SFN
6d	2	T15N200SFB	T15N200SFN
8d	2 ½	T15N250SFB	T15N250SFN

Type 304 Stainless Steel

Penny Size	Length (in.)	500-Count Model No.	4,000-Count Model No.
4d	1 ½	S15N150SFB	S15N150SFN
6d	2	S15N200SFB	S15N200SFN
8d	2 ½	S15N250SFB	S15N250SFN

Specialty

L Series Flooring Cleats

Ideal for tongue-and-groove decking and flooring

Compatible Pneumatic Tools

If you don't see your particular model in the table below, see strongtie.com/toolmatrix or call Simpson Strong-Tie for assistance with fastener selection (800) 999-5099.

Bostitch®	MFN200, MFN201, MIIIFN
Grip-Rite®	GR200LCN
Hitachi®	NT50AF
Porter Cable®	FCN200
PowerNail®	45, 45R, 445SN, 101SN, 101R, 445, 445 FLEX Power Roller
Primatech®	P210L, P240L, P250L, H300L, H330L
Senco®	SHF50, SHF15

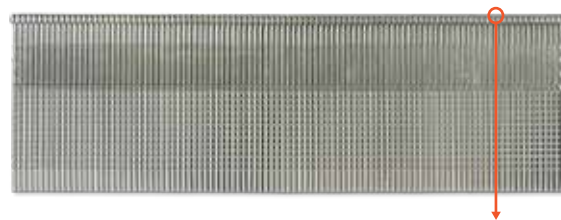

Type 304 Stainless Steel

Gauge	Length (in.)	Carton Quantity	Model No.
16	1 ½	1,000	S16B150LCT
16	2	1,000	S16B200LCT

T Series Flooring Cleats

Ideal for tongue-and-groove decking and flooring

Compatible Pneumatic Tools

If you don't see your particular model in the table below, see strongtie.com/toolmatrix or call Simpson Strong-Tie for assistance with fastener selection (800) 999-5099.

Hitachi®	NT50AF, NT50AGF, NT50YF
Primatech®	P210T, P240T, P250T, H300T, H330T

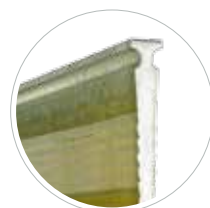
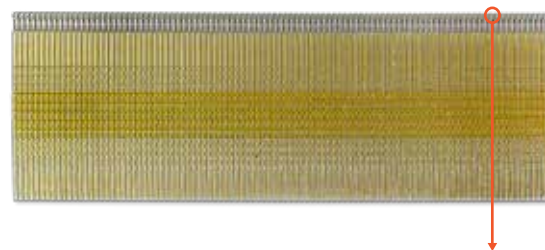

Type 304 Stainless Steel

Gauge	Length (in.)	Carton Quantity	Model No.
16	2	1,000	S16B200TNL

Collated Staples

½" Crown, 15½-Gauge Staples

(Similar to Bostitch® "BCS" Series)

Ideal for tongue-and-groove decking

Compatible Pneumatic Tools

If you don't see your particular model in the table below, see strongtie.com/toolmatrix or call Simpson Strong-Tie for assistance with fastener selection (800) 999-5099.

Bostitch®	MIIIFS
Grip-Rite®	GR200FS
Hitachi®	N5009AF
PowerNail®	445FS, 445FS w/Power Roller
Primatech®	P220, P250S, P260



Type 304 Stainless Steel

Gauge	Length (in.)	Carton Quantity	Model No.
15½	2	5,000	S15N200BFS

1" Crown, 16-Gauge Staples

(Similar to Senco® "P" Series)

Compatible Pneumatic Tools

If you don't see your particular model in the table below, see strongtie.com/toolmatrix or call Simpson Strong-Tie for assistance with fastener selection (800) 999-5099.

Duo-Fast®	SW1748
Grip-Rite®	GRT1200-2
Hitachi®	N5024A2
Makita®	AT2550A
Senco®	MWXD, WC150XP, WC200XP



Type 316 Stainless Steel

Gauge	Length (in.)	Carton Quantity	Model No.
16	1	5,000	T16N100P53

Type 304 Stainless Steel

Gauge	Length (in.)	Carton Quantity	Model No.
16	¾	5,000	S16N075P51
16	1¼	5,000	S16N125P55

Collated Staples

1/2" Crown, 16-Gauge Staples

(Similar to Paslode® "GS" Series)

Compatible Pneumatic Tools

If you don't see your particular model in the table below, see strongtie.com/toolmatrix or call Simpson Strong-Tie for assistance with fastener selection (800) 999-5099.

DeWalt® D51431

Hitachi® N5010A

Paslode® S200-S16, 900078NT



Type 304 Stainless Steel

Gauge	Length (in.)	1,000-Count Model No.	Carton Quantity	Carton Model No.
16	1 1/4	S16N125GS-R1000	10,000	S16N125GS
16	1 1/2	S16N150GS-R1000	10,000	S16N150GS
16	1 3/4	S16N175GS-R1000	10,000	S16N175GS
16	2	—	10,000	S16N200GS

Collated Staples

1/4" Crown, 18-Gauge Staples

(Similar to Senco® "L" Series)

Compatible Pneumatic Tools

If you don't see your particular model in the table below, see strongtie.com/toolmatrix or call Simpson Strong-Tie for assistance with fastener selection (800) 999-5099.

Bosch®	STN150-18
DeWalt®	D51420K (up to 1"), D51422K
Duo-Fast®	SureShot 1848F, SureShot 1832 (up to 1"), SureShot 1848, SureShot 1848SL, SureShot 1832ST (up to 1")
Grip-Rite®	GRTSN100 (up to 1"), GRSTN150A
Hitachi®	N3804AB3
Makita®	AT638
Max®	TA238A/18-6, TA238/18-6
Porter Cable®	NS100B (up to 1"), NS150B
Ridgid®	R150FSA
Senco®	SLS18MG



Type 316 Stainless Steel

Gauge	Length (in.)	Carton Quantity	Model No.
18	5/8	5,000	T18N062L10
18	3/4	5,000	T18N075L11
18	1	5,000	T18N100L13
18	1 1/8	5,000	T18N112L14
18	1 1/4	5,000	T18N125L15
18	1 1/2	5,000	T18N150L17

Type 304 Stainless Steel

Gauge	Length (in.)	1,000-Count Model No.	Carton Quantity	Carton Model No.
18	5/8	—	5,000	S18N062L10
18	1	S18N100L13-R1000	5,000	S18N100L13
18	1 1/8	—	5,000	S18N112L14
18	1 1/4	S18N125L15-R1000	5,000	S18N125L15
18	1 1/2	S18N150L17-R1000	5,000	S18N150L17

Collated Staples

7/16" Crown, 16-Gauge Staples

(Similar to Senco® "N" Series)

Compatible Pneumatic Tools

If you don't see your particular model in the table below, see strongtie.com/toolmatrix or call Simpson Strong-Tie for assistance with fastener selection (800) 999-5099.

Bostitch®	438S5 (up to 1½"), 650S5
DeWalt®	D51430
Duo-Fast®	SM7648 (up to 1½"), SM7664, MS-7664E
Grip-Rite®	GRSTSM200
Hitachi®	N5008AC2
Makita®	AT1150A
Max®	TA551A/16-11, TA551/76, TA551/16-11
Porter Cable®	MS200
Senco®	SNS41, SNS44XP, SDS45XP, SNS50XP



Type 316 Stainless Steel

Length (in.)	Carton Quantity	Carton Model No.
¾	5,000	T16N075N11
1¼	5,000	T16N125N15
1½	5,000	T16N150N17
1¾	5,000	T16N175N19
2	5,000	T16N200N21

Type 304 Stainless Steel

Length (in.)	1,000-Count Model No.	Carton Quantity	Carton Model No.
1	—	5,000	S16N100N13
1¼	S16N125N15-R1000	5,000	S16N125N15
1½	S16N150N17-R1000	5,000	S16N150N17
1¾	—	5,000	S16N175N19
2	S16N200N21-R1000	5,000	S16N200N21

Strong-Drive® XL LARGE-HEAD METAL Screw

**Economic.
Ergonomic.
Easy.**

Quik Drive® BSD200





Quik Drive® Systems Applications



Subfloor/Sheathing	188
Decks, Docks and Boardwalks	190
Drywall	192
Fiberglass-Mat Gypsum Sheathing	194
Fiber-Cement Siding	195
Standing-Seam Metal Roofing	197
Exposed-Fastener Metal Roofing/Siding	198
Tile Roofing	200
Steel Framing/Stitching	202
Steel Decking/Stitching	204
Underlayment/Backerboard	206
Truck Beds/Trailer Flooring	208
Crating	210
Truss-Ply Fastening	212
Nailers/Ledgers-to-Steel	214

Subfloor/Sheathing Applications



Quik Drive® auto-feed screw driving systems are ideal for subfloor installation, combining the efficiency of stand-up driving with the holding power of screws. Screws are superior to nails in this application because they reduce the gaps that cause floor squeaks.

PRO250 System



- Expanded depth settings for high-density flooring materials
- Uniform toenailing and countersink on slick surfaces
- Reversible and replaceable non-skid teeth
- Details, p. 222

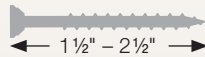

PROSDD Combo System



- Expanded depth settings for appropriate countersink in a variety of applications
- Includes both PRO300S Attachment and PRO200 Attachment for added versatility
- Reversible and replaceable non-skid teeth
- Sure-grip guide tube increases stability for a broad range of screws
- Details, p. 232

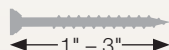

Subfloor/Sheathing Applications





PROCCS+ Combo System

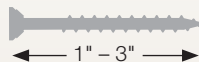

- Includes both PRO300S Attachment and PRO200S Attachment for added versatility
- Expanded depth settings for high-density flooring materials
- Reversible and replaceable non-skid teeth
- Sure-grip guide tube increases stability for a broad range of screws
- Details, p. 233



Collated Screws for the Quik Drive® System

Fastener Model	PRO250	PROSDD/CCS+	PRO300s
Strong-Drive® WSNTL SUBFLOOR Screw  Wood-to-wood applications, yellow zinc coating, sharp point, p. 268	1¾", 2", 2½"	1¾", 2", 2½", 3"	1¾", 2", 2½", 3"
Strong-Drive® WSV SUBFLOOR Screw  Wood-to-wood applications, yellow zinc coating, sharp point, p. 267	1¾"	1¾"	1¾"
Strong-Drive® PPSD SHEATHING-TO-CFS Screw  Wood-to-steel applications, #2 drill point Quik Guard® and yellow zinc coating, p. 276	#10 x 1¾", #8 x 1¹⁵⁄₁₆"	#10 x 1¾", #8 x 1¹⁵⁄₁₆", #10 x 3"	#10 x 1¾", #8 x 1¹⁵⁄₁₆", #10 x 3"
WSHL Subfloor Screw  Wood-to-wood applications, gray phosphate coating, p. 270	1¾"	1¾"	1¾"
WSC Wood Screw  Wood-to-wood applications, yellow zinc coating, coarse thread, p. 273	1½"	1½"	1½"

Decks, Docks and Boardwalks Applications



Quik Drive® auto-feed screw driving systems are ideal for fastening decking because they combine the efficiency of stand-up driving with the holding power of screws, providing the best long-term results.

PRO300S System



Includes a decking nose clip to position decking screws quickly and precisely every time

- Expanded depth settings for appropriate countersink in a variety of applications
- Reversible and replaceable non-skid teeth
- Uniform toenailing and countersink on slick surfaces
- Sure-grip guide tube increases stability for a broad range of screws
- Details, p. 223

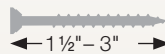

PROSDD Combo System





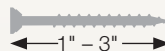



- Expanded depth settings for appropriate countersink in a variety of applications
- Includes both PRO300S Attachment and PRO200 Attachment for added versatility
- Reversible and replaceable non-skid teeth
- Uniform toenailing and countersink on slick surfaces
- Details, p. 232

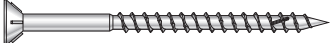

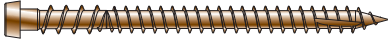
Decks, Docks and Boardwalks Applications

Collated Screws for the Quik Drive® System

Fastener Model	PROSDD/CCS+	PR0300s
Deck-Drive™ DSV WOOD Screw  Rimmed flat-head, Quik Guard coating, p. 256	2", 2½", 3"	2", 2½", 3"
Deck-Drive™ DWP WOOD SS Screw  Types 316 and 305 stainless steel, p. 257	2½", 3"	2½", 3"
Deck-Drive™ DHPD HARDWOOD Screw  Paddle-style drill point, Type 305 stainless steel, p. 257	2½"	2½"
Deck-Drive™ DCSD COMPOSITE-TO-STEEL Screw  Drill point, Quik Guard® coating, p. 266	2¾"	2¾"
Deck-Drive™ DCU COMPOSITE Screw  Composite-decking screw, Type 316 and 305 stainless steel and Quik Guard® coating, colors available, p. 265	2¾"	2¾"
Bugle-Head Wood Screw  Types 316 and 305 stainless steel, #10 bugle head, p. 259	2½", 3"	2½", 3"
Trim-Head Screw: Sharp Point  Type 305 stainless steel, #8 trim head, p. 258	2", 2½", 3"	2", 2½", 3"
Trim-Head Screw: Type-17 Point  Trim head, Quik Guard coating, p. 259	2", 2½", 3"	2", 2½", 3"

Drywall Applications



Quik Drive® auto-feed screw driving systems are ideal for fastening drywall. They provide a fast, efficient solution with a precision countersink adjustment that produces consistent dimples.

PRO200 System



- Compact body for reduced weight and easy handling
- Smooth nose will not mar drywall surface
- Slim profile allows driving in corners
- Details, p. 220

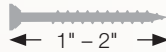

PRO250DW Attachment





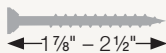

- Compact body for reduced weight and easy handling
- Smooth nose will not mar drywall surface
- Slim profile allows driving in corners
- Details, p. 237



Drywall Applications

Collated Screws for the Quik Drive® System

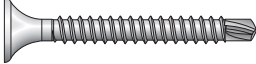
Fastener Model	PRO200	PRO250DW
<p>DWHL Drywall Screw</p>  <p>High-low threads, gray phosphate coating, p. 271</p>	1 7/8"	1 7/8"
<p>DWC Drywall Screw</p>  <p>Drywall to wood, gray phosphate and yellow zinc coatings available, p. 270</p>	1", 1 1/4", 1 5/8", 2"	2", 2 1/2"
<p>DWF Drywall-to-CFS Screw</p>  <p>Drywall to steel, gray phosphate coating (33, 27, 18 mil / 20, 22, 25 ga.), p. 282</p>	1 1/4", 1 5/8"	N/A
<p>DWFSD Drywall-to-CFS Screw</p>  <p>Drywall to steel, #2 point, yellow zinc coating (54, 43 mil / 16, 18 ga.), p. 282</p>	1 1/4", 1 5/8", 1 7/8"	1 7/8", 2 3/8"
<p>DWFSD Drywall-to-CFS Screw</p>  <p>Drywall to steel, #2 point, Quik Guard® coating (54, 43 mil / 16, 18 ga.), p. 282</p>	1 1/4"	1 1/4"

Fiberglass-Mat Gypsum Sheathing Applications



Quik Drive® auto-feed screw driving systems provide a time-saving fastening method combined with the holding power of screws. Screw threads create a secure, vibration-resistant connection that prevents sheathing from shaking loose while traveling from the panel yard to the jobsite.

PRO200 System





- Compact body for reduced weight and easy handling
- Slim profile allows driving in corners
- Details, p. 220

Swivel Adapter (sold separately)

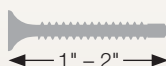
- Rotates 360° without having to detach the tool from motor
- Allows for one-handed rotation of tool
- Easily rotate screws out of the way for corner applications



Collated Screws for the Quik Drive® System

Fastener Model	PRO200
DWFS Drywall-to-CFS Screw  Yellow zinc coating, p. 282	1 1/4", 1 5/8", 1 7/8"
DWFS Drywall-to-CFS Screw  Quik Guard® coating, p. 282	1 1/4"

For information on corrosion, materials and coatings, see pp. 17-21.

Fiber-Cement Siding Applications



Quik Drive® auto-feed screw driving systems save time when installing siding because they enable fast, efficient fastening along with a countersink adjustment to ensure consistent results.

PRO250 System



- Uniform toenailing and countersink on slick surfaces
- Non-skid nose increases stability
- Long-lasting reliability for a wide variety of applications
- Details, p. 222

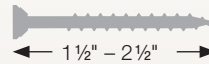

PROCGB Combo System



- Includes both PROLDH Attachment and PRO200S Attachment for added versatility
- Uniform toenailing and countersink on slick surfaces
- Non-skid nose increases stability
- Long-lasting reliability for a wide variety of applications
- Details, p. 234

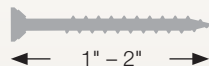

Fiber-Cement Siding Applications

PROLDH System



- Slim profile allows driving in corners
- Drives fasteners that meet ANSI standards
- Compact body for reduced weight and easy handling
- Details, p. 227

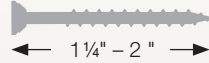

Collated Screws for the Quik Drive® System

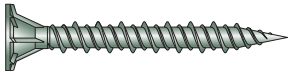
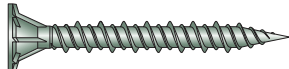
Fastener Model	PRO200S	PROCGB	PROLDH	PRO250
CBSDQ Sheathing Screw*  Self-drilling screw * #2 drill point, Quik Guard® coating, p. 281	1 5/8"	1 5/8"	—	2 1/4"
CB3BLG Fiber-Cement Board Screw  Type 17 point, C-3 galvanized coating, p. 260	—	1 1/4", 1 5/8"	1 1/4", 1 5/8"	—
CB3BLGHL Cement Board Screw  High-low thread, C-3 galvanized coating, p. 260	—	1 1/4", 1 5/8"	1 1/4", 1 5/8"	—

* #2 Drill Point with Wings

Wings cut a path, protecting the integrity of the threads and break away before penetrating the steel.

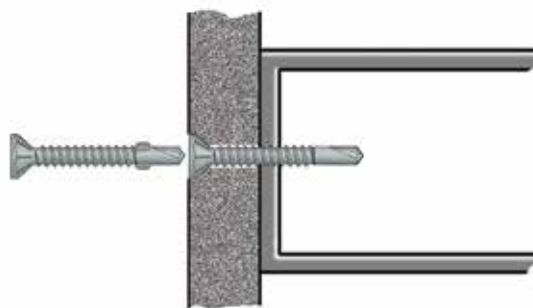

Warning: Industry studies show that hardened fasteners can experience performance problems in wet or corrosive environments. Accordingly, use this product in dry, interior and noncorrosive environments only.

For information on corrosion, materials and coatings, see pp. 17-21.

Standing-Seam Metal Roofing Applications



The Quik Drive® PROPP150 auto-feed screw driving system is ideal for standing-seam metal roofing. The Precision Placement™ nosepiece cuts installation time and the collated fasteners eliminate handling of individual screws.

PROPP150 System



- Innovative Precision Placement nosepiece allows for easy location of the hole in the clip
- Hands-free screw advancement speeds installation
- Collated fastener strips reduce waste and prevent damage to roof panels
- Suitable for panel clips up to 2½" tall
- Also ideal for fastening panel flanges for snap-and-seam metal roofing and installing trim and drip edge
- Details, p. 231

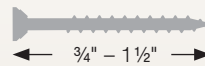

Collated Screws for the Quik Drive® System

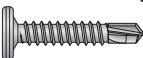
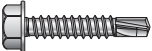
Fastener Model	PROPP150
PC Standing-Seam-Roofing Panel Clip Screw  Type 17 point, Type 410 stainless steel, Quik Guard® and clear zinc coating, pp. 263, 272	1", 1½"
PCSD Standing-Seam-Roofing Panel Clip Screw  #3 drill point, Type 410 stainless steel, Quik Guard® and clear zinc coating, p. 280	1"
Strong-Drive® SELF-DRILLING X METAL Screw  5/16" hex head, Quik Guard® and clear zinc coating, p. 278	1"

Warning: Industry studies show that hardened fasteners can experience performance problems in wet or corrosive environments. Accordingly, use this product in dry, interior and noncorrosive environments only.

For information on corrosion, materials and coatings, see pp. 17-21.

Exposed-Fastener Metal Roofing/Siding Applications

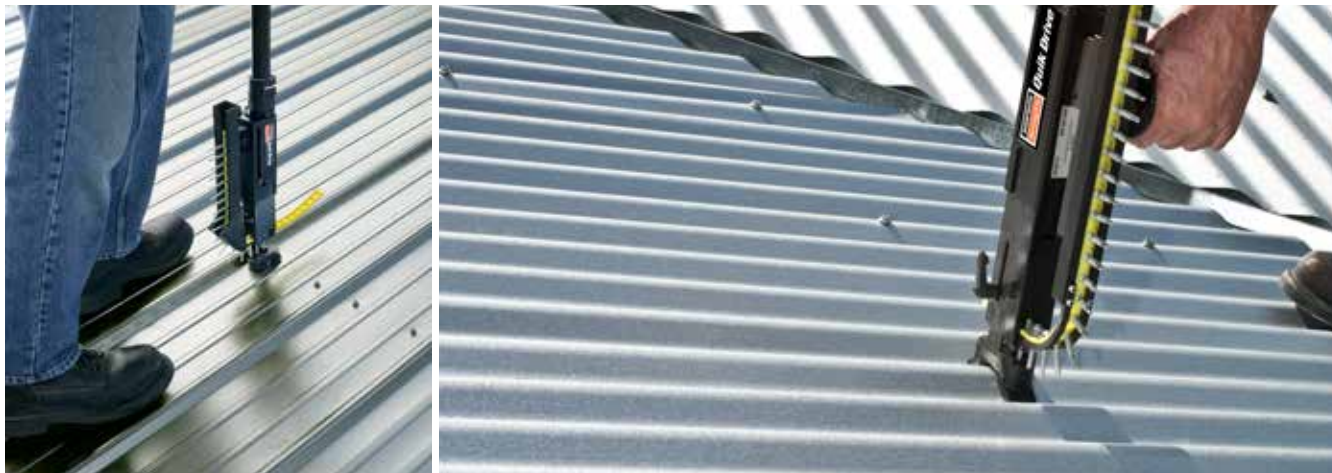

The Quik Drive® BGP300 and PROHX14 auto-feed screw driving systems are ideal for metal roofing and siding, speeding installation of washered screws while providing consistent results.

BGP300 System



- Patented collation belt enables auto-feed fastening of screws with EPDM-backed washers
- The extension enables stand-up fastening on low-pitch roofs
- Depth control prevents over-driving
- Designed to eliminate skipped screws, reducing screw waste
- Easy loading keeps work moving
- Screws available in 10 colors to match popular roofing-panel colors
- Details, p. 219



PROHX14 System



- Patented strip collation enables auto-feed fastening of screws with EPDM-backed washers
- The extension enables stand-up fastening on low-pitch roofs
- Depth control prevents over-driving
- Designed to eliminate skipped screws, reducing screw waste
- Easy loading keeps work moving
- Screws available in 10 colors to match popular roofing-panel colors
- Details, p. 226

Exposed-Fastener Metal Roofing/Siding Applications

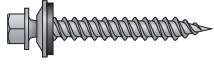
Collated Screws for the Quik Drive® System

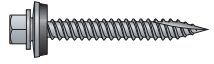
Fastener Model	BGP300	PROHX14
<p>HJ Metal Roofing/Siding Panel Screw</p>  <p>¼" hex head, sharp point, painted, p. 261</p> 	1½"	—
<p>HG Metal Roofing/Siding Panel Screw</p>  <p>¼" hex head, Type 17 point, exterior-grade coating, p. 261</p>	1½"	1½"

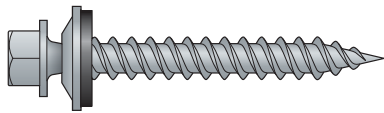

EPDM-backed washers are preassembled on the screw, ready to drive.

Tile Roofing Applications



Quik Drive® auto-feed screw driving systems are a time-saving solution for tile roofing. The collated fastening strips eliminate the handling of individual screws and the attachments are designed for easy location of the holes in the tiles.

PRORF System



- Secure depth settings prevent tile breakage
- Window in guide tube allows exact screw placement
- Long-lasting reliability for tile roofing applications
- Details, p. 228

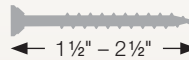

PRO300SRF System



- Secure depth settings prevent tile breakage
- Window in guide tube allows exact screw placement
- Long-lasting reliability for tile roofing applications
- Details, p. 229

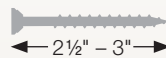

Tile Roofing Applications

Collated Screws for the Quik Drive® System

Fastener Model	PRORF	PR0300SRF
<p>WSCD Roofing Tile Screw</p>  <p>Miami-Dade compliant, meets ASTM B695, Class 55 galvanized coating, p. 264</p>	2½"	2½", 3"
<p>WSCT Roofing Tile Screw</p>  <p>Meets ASTM A641 Class 1 standard, heavy zinc electroplate coating, p. 264</p>	2½"	2½"
<p>SSWSCB Roofing Tile Screw</p>  <p>SSWSCB screw Miami-Dade compliant, Type 305 stainless steel, p. 264</p>	2", 2½"	2½"

Steel Framing/Stitching Applications



Quik Drive® auto-feed screw driving systems save time when fastening cold-formed steel framing. The collated fastening strips eliminate the handling of individual screws and the attachments hold the screw in place while it drills through the material.

PROPH Attachment



- Compact body for reduced weight and easy handling
- Slim profile allows driving in corners
- Long-lasting reliability for targeted applications
- Details, p. 241

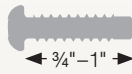

PROHX516 Attachment





- Engineered to drive screws for steel fastening
- Precise depth adjustment prevents over and under driving
- Long-lasting reliability for targeted applications
- Details, p. 240

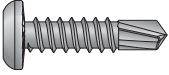

Steel Framing/Stitching Applications

Collated Screws for the Quik Drive® System

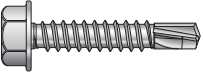
Fastener Model	PROPH	PROHX516
Strong-Drive® FPHSD FRAMING-TO-CFS Screw  Flat pan head, #3 drill point, clear zinc coating, p. 275	3/4"	—
Strong-Drive® PHSD FRAMING-TO-CFS Screw  Pan head, #2 drill point, yellow zinc coating, p. 275	3/4"	—
Strong-Drive® SELF-DRILLING X METAL Screw  5/16" hex head, clear zinc coating, p. 278	—	7/8"–1"

Steel Decking/Stitching Applications



The Quik Drive® PROSDX150 auto-feed screw driving system is the right choice for steel decking because it provides an efficient fastening solution that is safer and easier than welding or P.A.T.

PROSDX150 System



- Features an extended nosepiece for easy access to valley
- Stand-up driving increases comfort and productivity
- One system for fastening steel decking to structural members and steel stitching
- No special inspection or certification required as with welding or P.A.T. fastening
- Details, p. 230





BSD200 System



- Innovative Precision Placement™ nosepiece allows for easy location of the standing seam metal roofing clip holes
- Stand-up driving increases comfort and productivity
- Patented belt collation enables auto-feed fastening of screws
- Depth control prevents over driving
- Details, p. 218

Steel Decking/Stitching Applications

Collated Screws for the Quik Drive® System

Fastener Model	PROSDX150	BSD200
Strong-Drive® SELF-DRILLING X METAL Screw  Quik Guard® coating, 5/16" hex head, p. 278	1", 1 1/4", 1 1/2"	—
Strong-Drive® SELF-DRILLING X METAL Screw  Clear zinc coating, 5/16" hex head, p. 278	3/4", 1", 1 1/4"	—
Strong-Drive® XL LARGE-HEAD METAL Screw  Quik Guard® coating, 5/16" hex head, p. 277	—	1 1/4"
Strong-Drive® XM MEDIUM-HEAD METAL Screw  Quik Guard® coating, 5/16" hex head, p. 277	1 1/4"	—

Underlayment/Backerboard Applications



Quik Drive® auto-feed screw driving systems are ideal for underlayment. The variety of screws solves challenges such as driving over radiant heat panels and the extension enables stand-up-and-drive installation.

PROCGB Combo System



- Slim profile allows driving in corners
- Drives fasteners that meet ANSI standards
- Compact body for reduced weight and easy handling
- Includes both PROLDH Attachment and PRO200S Attachment for added versatility
- Details, p. 234

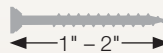

PROLDH System



- Slim profile allows driving in corners
- Compact body for reduced weight and easy handling
- Details, p. 227

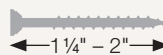

Underlayment/Backerboard Applications





PRO200S System

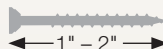

- Slim profile allows driving in corners
- Compact body for reduced weight and easy handling
- Details, p. 221

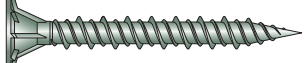

Collated Screws for the Quik Drive® System

Fastener Model	PROCGB	PROLDH	PRO200S
CB3BLG Fiber-Cement Board Screw  Dense cement board, C-3 mechanically galvanized coating, meets ANSI standards, p. 260	1 ¼", 1 ½"	1 ¼", 1 ½"	—
CB3BLGHL Cement Board Screw  Cement board to wood (for coarse, porous, and softer materials), C-3 mechanically galvanized coating, p. 260	1 ¼", 1 ½"	1 ¼", 1 ½"	—
DWF Drywall-to-CFS Screw  Gypsum panel to steel, gray phosphate coating, p. 282	1 ¼", 1 ½"	—	1 ¼", 1 ½"
DWFSD Drywall-to-CFS Screw  Gypsum panel to steel, yellow zinc or Quik Guard® coating, p. 282	1 ¼", 1 ½"	—	1 ¼", 1 ½"
MTH Wood Underlayment Screw  Underlayment to wood, yellow zinc and gray phosphate coating, p. 271	1", 1 ¼"	—	1", 1 ¼"
DWC Drywall Screw  Gypsum panel to wood, gray phosphate coating, p. 270	1 ¼", 1 ½", 2"	—	1 ¼", 1 ½", 2"

C-F-2017 ©2017 SIMPSON STRONG-TIE COMPANY INC.

Quik Drive Systems Applications

Truck Beds/Trailer Flooring Applications



Quik Drive® PROHSD auto-feed fastening systems are a time-saving solution for truck and trailer manufacturing because the extension enables stand-up driving and our self-drilling screws eliminate the need to predrill.

PROHSD60 System



- Specifically engineered for trailer construction
- Expanded depth settings for various material thickness
- Broad nose increases stability and protects surfaces
- Details, p. 224

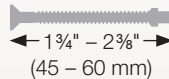

PROHSD75 System



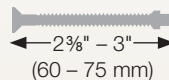

- Specifically engineered for trailer construction
- Expanded depth settings for various material thickness
- Broad nose increases stability, protects surfaces
- Details, p. 225

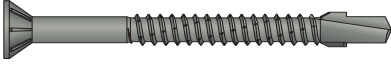

Truck Beds/Trailer Flooring Applications

Collated Screws for the Quik Drive® System

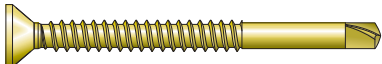
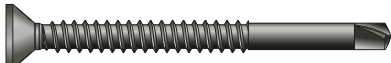
Fastener Model	PROHSD60	PROHSD75
Strong-Drive® TB WOOD-TO-STEEL Screw  #4 drill point, black phosphate coating, p. 274	1 3/4", 2 3/8" (45, 60 mm)	2 3/8", 3" (60, 75 mm)
Strong-Drive® TB WOOD-TO-STEEL Screw  #4 drill point, N2000® galvanized coating, p. 274	1 3/4", 2 3/8" (45, 60 mm)	2 3/8", 3" (60, 75 mm)
Strong-Drive® TB WOOD-TO-STEEL Screw  #4 drill point, yellow zinc coating, p. 274	1 3/4", 2 3/8" (45, 60 mm)	2 3/8", 3" (60, 75 mm)
Strong-Drive® PPSD SHEATHING-TO-CFS Screw  #3 drill point, yellow zinc coating, p. 276	#12 x 1 3/4"	#12 x 3"
Strong-Drive® PPSD SHEATHING-TO-CFS Screw  #3 drill point, Quik Guard® coating, p. 276	#12 x 1 3/4"	#12 x 3"

Crating Applications



Quik Drive® auto-feed screw driving systems save time when building crates by enabling accurate screw placement and hands-free fastener advancement.

PRO250 System



- Expanded depth settings for appropriate countersink in a variety of applications
- Uniform toenailing and countersink on slick surfaces
- Reversible and replaceable non-skid teeth attachment
- Details, p. 222

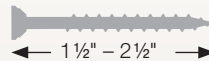

PRO300S System





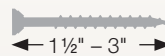

- Expanded depth settings for appropriate countersink in a variety of applications
- Reversible and replaceable non-skid teeth attachment
- Uniform toenailing and countersink on slick surfaces
- Sure-grip guide tube increases stability for a broad range of screws
- Details, p. 223



Crating Applications

Collated Screws for the Quik Drive® System

Fastener Model	PR0250	PR0300S	PR0200S
<p>Strong-Drive® WSNTL WOOD Screw</p>  <p>Twin thread, p. 267</p>	1¾", 2", 2½"	1¾", 2", 2½", 3"	1¾", 2"
<p>Strong-Drive® WSV SUBFLOOR Screw</p>  <p>Variable thread design, yellow zinc coating, p. 267</p>	1¾"	1¾"	1¾"
<p>WSHL Wood Screw</p>  <p>High-low threads, gray phosphate coating, p. 270</p>	1¾"	1¾"	1¾"
<p>PHSS Wood Screw</p>  <p>Sharp point, yellow zinc coating, p. 273</p>	2½"	2½"	—
<p>DWC Drywall Screw</p>  <p>Drywall to wood, gray phosphate coating, p. 270</p>	—	—	1¼", 1⅝"

Truss-Ply Fastening Applications



Quik Drive® auto-feed screw driving systems are ideal for truss-ply fastening because the extension enables stand-up-and-drive installation and the holding power of screws can reduce the gapping between plies, improving the quality of the girder.

PRO250 System



- Expanded depth settings for high-density flooring materials
- Uniform toenailing and countersink on slick surfaces
- Reversible and replaceable non-skid teeth attachment
- Details, p. 222

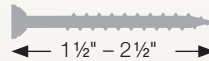

PRO300S System



- Expanded depth settings for appropriate countersink in a variety of applications
- Reversible and replaceable non-skid teeth attachment
- Sure-grip guide tube increases stability for a broad range of screws
- Details, p. 223

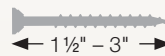

Truss-Ply Fastening Applications

PROCCS+ Combo System



- Expanded depth settings for appropriate countersink in a variety of applications
- Reversible and replaceable non-skid teeth attachment
- Includes both PRO300S Attachment and PRO200S Attachment for added versatility
- Sure-grip guide tube increases stability for a broad range of screws
- Details, p. 233

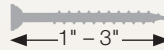

Collated Screws for the Quik Drive® System

Fastener Model	PRO250	PRO300S/CCS+
 Strong-Drive® WSNTL WOOD Screw Twin thread, p. 267	2½"	2½", 3"

Nailers/Ledgers-to-Steel Applications



Quik Drive® PROHSD auto-feed fastening systems are ideal for wood-to-steel fastening. They hold the screw in place while drilling and our self-drilling screws eliminate the need for pre-drilling.

PROHSD60 System



- Specifically engineered for fastening wood-to-steel
- Expanded depth settings for various material thickness
- Broad nose increases stability and protects surfaces
- Details, p. 224



PROHSD75 System





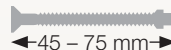

- Specifically engineered for fastening wood-to-steel
- Expanded depth settings for various material thickness
- Broad nose increases stability and protects surfaces
- Details, p. 225



Nailers/Ledgers-to-Steel Applications

Collated Screws for the Quik Drive® System

Fastener Model	PROHSD60	PROHSD75
Strong-Drive® TB WOOD-TO-STEEL Screw  Black phosphate coating, p. 274	1¾", 2⅜" (45, 60 mm)	2⅜", 3" (60, 75 mm)
Strong-Drive® TB WOOD-TO-STEEL Screw  Yellow zinc coating, p. 274	1¾", 2⅜" (45, 60 mm)	2⅜", 3" (60, 75 mm)
Strong-Drive® TB WOOD-TO-STEEL Screw  N2000® galvanized coating, p. 274	1¾", 2⅜" (45, 60 mm)	2⅜", 3" (60, 75 mm)
Strong-Drive® PPSD SHEATHING-TO-CFS Screw  Quik Guard® coating, p. 276	#12 x 1¾"	#12 x 1¾", #12 x 3"
Strong-Drive® PPSD SHEATHING-TO-CFS Screw  Yellow zinc coating, p. 276	#12 x 1¾"	#12 x 1¾", #12 x 3"



Rethink
repetitive fastening.

Quik Drive® PRO250



Quik Drive® Systems

Quik Drive Systems

BSD200 Structural Steel-Decking System	218
BGP300 Metal-Roofing/Siding System	219
PRO200 Drywall System	220
PRO200S Multi-Purpose System	221
PRO250 Subfloor System	222
PRO300S Decking System	223
PROHSD60 Wood-to-Steel System	224
PROHSD75 Wood-to-Steel System	225
PROHX14 Metal Roofing/Siding System	226
PROLDH Underlayment/Backerboard System	227
PRORF Roofing Tile System	228
PRO300SRF Roofing Tile System	229
PROSDX150 Steel-Decking System	230
PROPP150 Metal Roofing System	231

Quik Drive Combo Systems

PROSDD Multi-Purpose Combo System	232
PROCCS+ Multi-Purpose Combo System	233
PROGCB Underlayment/Backerboard Combo System	234

Quik Drive Attachments

BSD200 Structural Steel-Decking Attachment	235
BGP300 Metal-Roofing/Siding Attachment	235
PRO200 Drywall Attachment	236
PRO200S Multi-Purpose Attachment	236
PRO250 Subfloor Attachment	237
PRO250DW Drywall Attachment	237
PRO300S Decking Attachment	238
PROHSD60 Wood-to-Steel Fastening Attachment	238
PROHSD75 Wood-to-Steel Fastening Attachment	239
PROHX14 Metal Roofing/Siding Attachment	239
PROHX516 Steel-to-Steel Fastening Attachment	240
PROLDH Underlayment/Backerboard Attachment	240
PROPH Cold-Formed Steel Framing Attachment	241
PRORF Roofing Tile Attachment	241
PRO300SRF Roofing Tile Attachment	242
PROSDX150 Steel-Decking Attachment	242
PROPP150 Metal Roofing Attachment	243

Parts and Accessories

Screwdriver Motors	244
Countersink and RPM Recommendations	246
Adapters	247
Replacement Parts	248
Accessories	249
Schematics and Troubleshooting	250
Quik Drive® — Warranty	251
Safety Warnings	251

BSD200 Structural Steel-Decking System

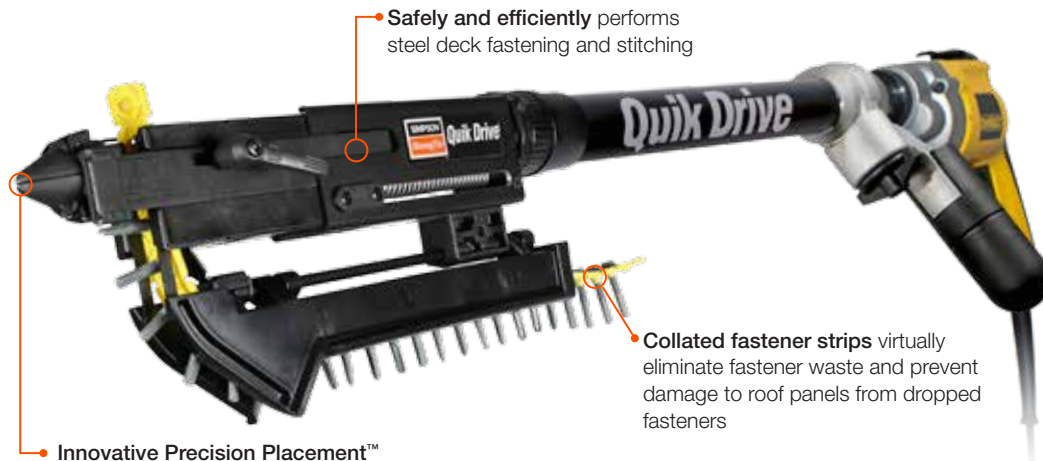

Safely and efficiently performs steel deck fastening and stitching

Innovative Precision Placement™ nosepiece allows for easy location of the holes in standing seam metal roofing clips

Collated fastener strips virtually eliminate fastener waste and prevent damage to roof panels from dropped fasteners

Applications: Steel decking and stitching; fastening for cold-formed steel; wide-valley nestable deck to structural steel members

- Patented belt collation enables auto-feed fastening of screws (U.S. Patent 6.7683,001)
- Profile guide on nosepiece ensures uniform screw placement
- The extension enables standup fastening
- Depth control prevents over-driving
- Designed to eliminate skipped screws, reducing screw waste (patent pending)

Limited lifetime warranty on attachment and extension, 1-year limited warranty on screw-driver motors (see specific manufacturer's warranty for more information)



The BSD200 System includes:

- BSD200 Structural Steel-Decking Attachment
- Extension for stand-up driving
- DeWalt® screwdriver motor
- Belt hook fastener-strip holder

BSD200 System

Drive These Collated Screws

Strong-Drive® XL Large-Head Metal Screw

p. 277

System	Model No.
DeWalt® 2,000 rpm adjustable torque motor	QDBSD200G2DATK
Parts	Model No.
Attachment only	QDBSD200G2
Replacement 5/16" hex bit	BITHEXLB516LG
Attachment and extension	QDBSD200G2K
Replacement extension	QDEXTG2-16
Replacement mandrel with 5/16" hex bit	BPHXLBGGP516G2

For more information on screwdriver motors and RPM recommendations per application, see pp. 244–245.

BGP300 Metal-Roofing/Siding System



The locking depth control seats the washer on the fastener and helps prevent overdriving that can damage metal roofing and siding.

Profile guides match the panel-ridge profiles with "feet" that rest on the flat portion of the panel. This centers the screw on the ridge for a uniform look and a better fastener seal.

Applications: Exposed-fastener metal roofing to wood, metal siding to wood

- Patented belt collation enables auto-feed fastening of screws with EPDM-backed washers (U.S. Patent 6,783,001)
- Profile guide on nosepiece ensures uniform screw placement
- Extension enables stand-up fastening on roofs
- Depth control prevents over-driving
- Designed to eliminate skipped screws, reducing screw waste (patent pending)

Limited lifetime warranty on attachment and extension, 1-year limited warranty on screw-driver motors (see specific manufacturer's warranty for more information)



The BGP300 System includes:

- BGP300 Metal-Roofing/Siding Attachment
- 2 profile guides (flat and AG Panel)
- 2 lobular hex-head driver bits (1/4" and 5/16")
- 16" extension for stand-up driving
- Belt hook fastener-strip holder
- Rugged tool case to protect your equipment on the jobsite

The BGP300 does not include a screwdriver motor.

BGP300 System

Drive These Collated Screws with EPDM-Backed Washers

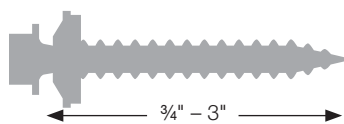

HJ Metal Roofing/Siding Panel Screw	p. 261
HG Metal Roofing/Siding Panel Screw	p. 261

System	Model No.
Attachment, 16" extension, (1) flat profile guide, (1) AG panel / 3/4" rib profile guide	QDBGP300G2K
Parts	Model No.
Replacement attachment mandrel with 1/4" hex bit	BPHXLBGP14G2
Replacement attachment mandrel with 5/16" hex bit	BPHXLBGP516G2

For more information on screwdriver motors and RPM recommendations per application, see pp. 244-245.

PRO200 Drywall System



Smooth nose will not mar drywall surface

Precise, self-locking depth adjustment for consistent dimples

Applications: Drywall to wood or steel

- Compact body for reduced weight and easy handling
- Slim profile allows driving in corners
- Smooth nose piece will not mar drywall surface
- Patented curved collation strips (U.S. Patent 7,051,875) hold the screws up and away from the work surface, making moving and positioning the tool easier. They are also pointed on the inserted end to simplify loading.

Limited lifetime warranty on attachment and extension, 1-year limited warranty on screw-driver motors (see specific manufacturer's warranty for more information)



The PRO200 System includes:

- PRO200 Drywall Attachment (also sold separately)
- Extension for stand-up driving
- Choice of Makita® or DeWalt® screwdriver motors
- Screw quiver for keeping screws at your fingertips
- Rugged tool case to protect your equipment on the jobsite

For longer drywall screws (2 1/4") see the PRO250DW attachment on p. 237.

PRO200 System

Drive These Collated Screws

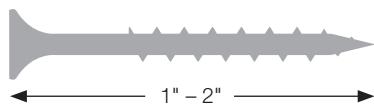

DWC Drywall Screw	p. 270
DWHL Drywall Screw	p. 271
DWF Drywall-to-CFS Screw	p. 282
DWFS Drywall-to-CFS Screw	p. 282

System Options	Model No.
DeWalt® 2,500 rpm screwdriver motor	PRO200G2D25K
Makita 2,500 rpm screwdriver motor	PRO200G2M25K
Parts	Model No.
Attachment only	QDPRO200G2
Replacement attachment mandrel	PMANDREL65

For more information on screwdriver motors and RPM recommendations per application, see pp. 244–245.

PRO200S Multi-Purpose System



Sure-grip guide tube
increases stability with shorter screws

Uniform toenailing and
countersink on slick surfaces

Applications: Subfloor to wood or steel, sheathing, fiber-cement siding to steel, gypsum panel to wood or steel

- Expanded depth settings for high-density flooring materials
- Reversible and replaceable non-skid teeth attachment
- Patented curved collation strips (U.S. Patent 7,051,875) hold the screws up and away from the work surface, making moving and positioning the tool easier. They are also pointed on the inserted end to simplify loading.

Limited lifetime warranty on attachment and extension, 1-year limited warranty on screw-driver motors (see specific manufacturer's warranty for more information)



The PRO200S System includes:

- PRO200S Multi-Purpose Attachment
- Extension for stand-up driving
- DeWalt® screwdriver motor
- Screw quiver for keeping screws at your fingertips
- Rugged tool case to protect your equipment on the jobsite

PRO200S System

C-F-2017 © 2017 SIMPSON STRONG-TIE COMPANY INC.

Drive These Collated Screws			
Strong-Drive® WSNTL Subfloor Screw	p. 268	DWC Drywall Screw	p. 270
Strong-Drive® WSV Subfloor Screw	p. 267	DWF Drywall-to-CFS Screw	p. 282
WSHL Subfloor Screw	p. 270	DWFS Drywall-to-CFS Screw	p. 282
WSC Wood Screw	p. 273	CBSDQ Sheathing-to-CFS Screw	p. 281
FHSD Wood-to-CFS Screw	p. 283	MTH Wood Underlayment Screw	p. 271

System Options	Model No.
DeWalt® 2,500 rpm screwdriver motor	PRO200SD25K
Parts	Model No.
Attachment only	QDPRO200S
Replacement mandrel	PMANDREL75

For more information on screwdriver motors and RPM recommendations per application, see pp. 244–245.

PRO250 Subfloor System



Applications: Subfloor to wood or steel

- Expanded depth settings for appropriate countersink in a variety of applications
- Reversible replaceable non-skid teeth attachment
- Uniform toenailing and countersink on slick surfaces
- The patented curved collation strips (U.S. Patent 7,051,875) hold the screws up and away from the work surface, making moving and positioning the tool easier. They are also pointed on the inserted end to simplify loading.

Limited lifetime warranty on attachment and extension, 1-year limited warranty on screw-driver motors (see specific manufacturer's warranty for more information)



The PRO250 System includes:

- PRO250 Subfloor Attachment (also sold separately)
- Extension for stand-up driving
- Choice of Makita® or DeWalt® screwdriver motors
- Screw quiver for keeping screws at your fingertips
- Rugged tool case to protect your equipment on the jobsite

PRO250 System

Drive These Collated Screws



Strong-Drive® WSNTL Subfloor Screw	p. 268	WSFLRV Wood-to-CFS/Aluminum Screw	p. 283
Strong-Drive® WSV Subfloor Screw	p. 267	WSC Wood Screw	p. 273
Strong-Drive® PPSD Sheathing-to-CFS Screw	p. 276	PHSS Wood Screw	p. 273
Deck-Drive™ DSV Wood Screw	p. 256	Trim-Head Screw: Type 17 point	p. 259
Deck-Drive™ DCSD Composite-to-Steel Screw	p. 266	DWC Drywall Screw	p. 270
WSHL Subfloor Screw	p. 270	DWFSD Drywall-to-CFS Screw	p. 282
CBSDQ Sheathing-to-CFS Screw	p. 281		

System Options	Model No.
DeWalt® 2,500 rpm screwdriver motor	PRO250G2D25K
Makita® 2,500 rpm screwdriver motor	PRO250G2M25K
Makita® 3,500 rpm screwdriver motor	PRO250G2M35K
Parts	Model No.
Attachment only	QDPRO250G2
Replacement attachment mandrel	PMANDREL75

For more information on screwdriver motors and RPM recommendations per application, see pp. 244–245.

PRO300S Decking System



Applications: Decking on decks and docks, subfloor to wood or steel, wall plates, stair treads, sheathing, fiber-cement siding to steel

- Expanded depth settings for high-density flooring materials
- Reversible and replaceable non-skid teeth
- Uniform toenailing and countersink on slick surfaces
- Sure-grip guide tube increases stability for a broad range of screws
- The patented curved collation strips (U.S. Patent 7,051,875) hold the screws up and away from the work surface, making moving and positioning the tool easier. They are also pointed on the inserted end to simplify loading.

Limited lifetime warranty on attachment and extension, 1-year limited warranty on screw-driver motors (see specific manufacturer's warranty for more information)



The PRO300S System includes:

- PRO300S Decking Attachment (also sold separately)
- Extension for stand-up driving
- Choice of Makita® or DeWalt® screwdriver motors
- Screw quiver for keeping screws at your fingertips
- Rugged tool case to protect your equipment on the jobsite
- Decking nose clip for accurate and consistent fastening

The decking nose clip positions the screw on the deck board and centers it on the joist for an easy, uniform installation from a standing position.

PRO300S System

C-F-2017 © 2017 SIMPSON STRONG-TIE COMPANY INC.

Drive These Collated Screws	
Deck-Drive™ DSV Wood Screw	p. 256
Deck-Drive™ DWP Wood SS Screw	p. 257
Deck-Drive™ DHPD Hardwood Screw	p. 257
Strong Drive® WSNTL Wood Screw	p. 267
Trim-Head Screw: Type 17 Point	p. 259
Trim-Head Screw: Sharp Point	p. 258
Bugle-Head Wood Screw	p. 259
CBSDQ Sheathing-to-CFS Screw	p. 281
Strong Drive® WSV Subfloor Screw	p. 267
Deck-Drive™ DCU Composite Screw	p. 265

System Options	Model No.
DeWalt® 2,500 rpm screwdriver motor	PRO300SD25K
Makita® 2,500 rpm screwdriver motor	PRO300SM25K
Makita® 3,500 rpm screwdriver motor	PRO300SM35K
Parts	Model No.
Attachment only	QDPRO300SG2
Replacement attachment mandrel	PMANDREL75

For more information on screwdriver motors and RPM recommendations per application, see pp. 244–245.

PROHSD60 Wood-to-Steel System



Applications: Truck beds and trailer flooring to steel, wood nailers to structural steel

- Slim profile allows driving in corners
- Compact body for reduced weight and easy handling

Limited lifetime warranty on attachment and extension, 1-year limited warranty on screw-driver motors (see specific manufacturer's warranty for more information)



The PROHSD60 System includes:

- PROHSD60 Wood-to-Steel Attachment (also sold separately)
- Extension for stand-up driving
- Choice of Hitachi® or Makita® screwdriver motors
- Screw quiver for keeping screws at your fingertips
- Rugged tool case to protect your equipment on the jobsite

PROHSD60 System

Drive These Collated Screws

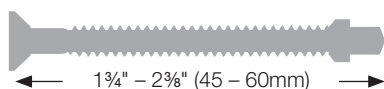

Strong-Drive® TB Wood-to-Steel Screw	p. 274
Strong-Drive® PPSD Sheathing-to-CFS Screw	p. 276

System Options	Model No.
Hitachi® 1,700 rpm screwdriver motor	PROHSD60H17K
Makita® 1,000–2,000 rpm screwdriver motor	PROHSD60MVK
Makita® 2,500 rpm screwdriver motor	PROHSD60M25K
Parts	Model No.
Attachment only	QDHS60
Replacement attachment mandrel	PMANDREL75

For more information on screwdriver motors and RPM recommendations per application, see pp. 244–245.

For applications where maximum torque is preferred, see the Hitachi® screwdriver motor HIW8VB2 on p. 244 (sold separately).

PROHSD75 Wood-to-Steel System



Applications: Truck beds and trailer flooring to steel, wood nailers to structural steel

- Slim profile allows driving in corners
- Compact body for reduced weight and easy handling

Limited lifetime warranty on attachment and extension, 1-year limited warranty on screw-driver motors (see specific manufacturer's warranty for more information)



The PROHSD75 System includes:

- PROHSD75 Wood-to-Steel Attachment (also sold separately)
- Extension for stand-up driving
- Choice of Hitachi® or Makita® screwdriver motors
- Screw quiver for keeping screws at your fingertips
- Rugged tool case to protect your equipment on the jobsite

PROHSD75 System

C-F-2017 ©2017 SIMPSON STRONG-TIE COMPANY INC.

Quik Drive Systems

Drive These Collated Screws	
Strong-Drive® TB Wood-to-Steel Screw	p. 274
Strong-Drive® PPSD Sheathing-to-CFS Screw	p. 276

System Options	Model No.
Hitachi® 1,700 rpm screwdriver motor	PROHSD75H17K
Makita® 1,000–2,000 rpm screwdriver motor	PROHSD75MVK
Parts	Model No.
Attachment only	QDHS75
Replacement attachment mandrel	PMANDREL75

For more information on screwdriver motors and RPM recommendations per application, see pp. 244–245.

For applications where maximum torque is preferred, see the Hitachi® screwdriver motor HIW8VB2 on p. 244 (sold separately).

PROHX14 Metal Roofing/Siding System



Applications: Exposed-fastener metal roofing-to-wood, metal siding-to-wood

- Precise depth adjustment prevents over and under driving
- Drives fasteners for steel-to-wood framing
- Tough reliability for targeted applications

Limited lifetime warranty on attachment and extension, 1-year limited warranty on screw-driver motors (see specific manufacturer's warranty for more information)



The PROHX14 System includes:

- PROHX14 Metal Roofing/Siding Attachment (also sold separately)
- Extension for stand-up driving
- Makita® screwdriver motor
- Screw quiver for keeping screws at your fingertips
- Rugged tool case to protect your equipment on the jobsite

PROHX14 System

Drive These Collated Screws

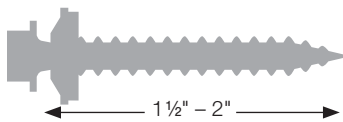

HG Metal Roofing/Siding Panel Screw

p. 261

For more information on corrosion, see pp. 17–21.

System Options	Model No.
Makita® 2,500 rpm screwdriver motor	PROHX14G2M25K
Parts	Model No.
Attachment only	QDPROHX14G2
Replacement attachment mandrel	BPHX14G2

For more information on screwdriver motors and RPM recommendations per application, see pp. 244–245.

PROLDH Underlayment/Backerboard System



Applications: Cement board and fiber-cement board underlayment/backerboard to wood or steel

- Slim profile allows driving in corners
- Drives fasteners that meet ANSI standards
- Compact body for reduced weight and easy handling

Limited lifetime warranty on attachment and extension, 1-year limited warranty on screw-driver motors (see specific manufacturer's warranty for more information)



The PROLDH System includes:

- PROLDH Underlayment/Backerboard Attachment (also sold separately)
- Extension for stand-up driving
- Makita® screwdriver motor
- Screw quiver for keeping screws at your fingertips
- Rugged tool case to protect your equipment on the jobsite

PROLDH System

C-F-2017 ©2017 SIMPSON STRONG-TIE COMPANY INC.

Drive These Collated Screws	
CB3BLG Fiber-Cement Board Screw	p. 260
CB3BLGHL Cement Board Screw	p. 260

System Options	Model No.
Makita® 2,500 rpm screwdriver motor	PROLDHG2M25K
Parts	Model No.
Attachment only	QDPROLDHG2
Replacement attachment mandrel	PMANDREL65

For more information on screwdriver motors and RPM recommendations per application, see pp. 244-245.

PRORF Roofing Tile System



• **Visibility window** allows precise visual placement of screws

Applications: Roofing tiles to wood

- Precision depth settings prevent tile breakage
- Window in guide tube provides visibility to allow exact screw placement
- Drives fasteners meeting code requirements

Limited lifetime warranty on attachment and extension, 1-year limited warranty on screw-driver motors (see specific manufacturer's warranty for more information)



The PRORF System includes:

- PRORF Roofing Tile Attachment (also sold separately)
- Choice of Makita® screwdriver motors
- Screw quiver for keeping screws at your fingertips
- Rugged tool case to protect your equipment on the jobsite

PRORF System

Drive These Collated Screws

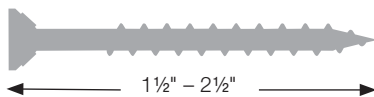

WSCD Roofing Tile Screw	p. 264
WSCT Roofing Tile Screw	p. 264
SSWSCB Roofing Tile Screw	p. 264

System Options	Model No.
Makita® 2,500 rpm screwdriver motor	PRORFG2M25K
Makita® 3,500 rpm screwdriver motor	PRORFG2M35K
Parts	Model No.
Attachment only	QDPRORFG2
Replacement attachment mandrel	PMANDREL75

For more information on screwdriver motors and RPM recommendations per application, see pp. 244–245.

PRO300SRF Roofing Tile System



Applications: Roofing tiles to wood

- Precision depth settings prevent tile breakage
- Window in guide tube provides visibility to allow exact screw placement
- Drives fasteners meeting code requirements
- The patented curved collation strips (U.S. Patent 7,051,875) hold the screws up and away from the work surface, making moving and positioning the tool easier. They are also pointed on the inserted end to simplify loading.

Limited lifetime warranty on attachment and extension, 1-year limited warranty on screw-driver motors (see specific manufacturer's warranty for more information)



The PRO300SRF System includes:

- PRO300SRF Roofing Tile Attachment (also sold separately)
- Choice of Makita® screwdriver motors
- Screw quiver for keeping screws at your fingertips
- Rugged tool case to protect your equipment on the jobsite

PRO300SRF System

C-F-2017 ©2017 SIMPSON STRONG-TIE COMPANY INC.

Drive These Collated Screws	
WSCD Roofing Tile Screw	p. 264
WSCT Roofing Tile Screw	p. 264
SSWSCB Roofing Tile Screw	p. 264

System Options	Model No.
Makita® 2,500 rpm screwdriver motor	PRO300SRFG2M25K
Makita® 3,500 rpm screwdriver motor	PRO300SRFG2M35K
Parts	Model No.
Attachment only	QDPRO300SRFG2
Replacement attachment mandrel	PMANDREL75

For more information on screwdriver motors and RPM recommendations per application, see pp. 244–245.

PROSDX150 Steel-Decking System



Innovative Precision Placement™ nosepiece for accurate driving and accurate location

Applications: Steel deck fastening to structural steel members; narrow-valley nestable and interlocking steel decking; side-lap stitching

- Features a Precision Placement™ nosepiece for accurate driving
- One system for fastening steel decking to structural members and steel stitching
- Designed for both the Strong-Drive® XM Medium-Head Metal screw and the Strong-Drive® Self-Drilling X Metal screw

Limited lifetime warranty on attachment and extension, 1-year limited warranty on screw-driver motors (see specific manufacturer's warranty for more information)



The PROSDX150 System includes:

- PROSDX150 Steel-Decking Attachment
- Extension for stand-up driving
- DeWalt® screwdriver motor
- Screw quiver for keeping screws at your fingertips

PROSDX150 System

Drive These Collated Screws

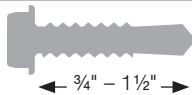

Strong-Drive® XM Medium-Head Metal Screw	p. 277
Strong-Drive® Self-Drilling X Metal Screw	p. 278

System Options	Model No.
DeWalt® 2,000 rpm adjustable torque motor	PROSDX150ATK
Parts	Model No.
Attachment only	QDPROSDX150G2
Replacement extension	QDEXTG2-16
Replacement 5/16" hex bit	BITHEXLB516LG
Replacement hex mandrel with 5/16" hex bit	BPHXLBSDG2

For more information on screwdriver motors and RPM recommendations per application, see pp. 244–245. System includes mandrels for driving recessed and 5/16" hex bits.

PROPP150 Metal Roofing System



Applications: Panel clips for standing-seam roofing, steel decking to structural steel members, panel flanges for snap-and-seam metal roofing

- Innovative Precision Placement™ nosepiece allows for easy location of the holes in standing seam metal roofing clips

- Auto-feed mechanism provides hands-free screw advancement, eliminating handling of individual screws, cutting installation time in half
- Screws available in four head styles with two levels of corrosion resistance

Limited lifetime warranty on attachment and extension, 1-year limited warranty on screw-driver motors (see specific manufacturer's warranty for more information)



The PROPP150 System includes:

- PROPP150 Metal Roofing Attachment (also sold separately)
- Choice of DeWalt® or Makita® screwdriver motors
- Screw quiver for keeping screws at your fingertips
- Rugged tool case to protect your equipment on the jobsite

U.S. Patents 5,570,618 and 8,356,534

PROPP150 System

C-F-2017 © 2017 SIMPSON STRONG-TIE COMPANY INC.

Drive These Collated Screws	
PC Standing-Seam-Roofing Panel Clip Screw	p. 272
PCSD Standing-Seam-Roofing Panel Clip Screw	p. 280
Strong-Drive® Self-Drilling X Metal Screw	p. 278

System Options	Model No.
DeWalt® 2,000 rpm adjustable-torque screwdriver motor	PROPP150G2DATK
Makita® 2,500 rpm screwdriver motor	PROPP150G2M25K
Parts	Model No.
Attachment only	QDPROPP150G2
Replacement attachment mandrel	PMANDREL10
Replacement hex bit and mandrel	BPHXLBPPG2

For more information on screwdriver motors and RPM recommendations per application, see pp. 244–245. System includes mandrels for driving recessed and 5/16" hex bits.

PROSDD Multi-Purpose Combo System



Non-skid teeth are reversible and replaceable

PRO300S Decking Attachment

PRO200 Drywall Attachment

Sure-grip guide tube increases stability for a broad range of screws

Applications: Decks/docks, subfloor, drywall, wallplates, stair treads, fiber-cement siding to steel

- Expanded depth settings for high-density flooring materials
- Uniform toenailing and countersink on slick surfaces
- Reversible and replaceable non-skid teeth
- The patented curved collation strips (U.S. Patent 7,051,875) hold the screws up and away from the work surface, making moving and positioning the tool easier. They are also pointed on the inserted end to simplify loading.

Limited lifetime warranty on attachment and extension, 1-year limited warranty on screw-driver motors (see specific manufacturer's warranty for more information)



The PROSDD Combo System includes:

- PRO300S Decking Attachment (also sold separately)
- PRO200 Drywall Attachment (also sold separately)
- Extension for stand-up driving
- Choice of DeWalt® or Makita® screwdriver motors
- Screw quiver for keeping screws at your fingertips
- Rugged tool case to protect your equipment on the jobsite

PROSDD Combo System

Drive These Collated Screws



Strong-Drive® WSNTL Subfloor	p. 268	Bugle-Head Wood Screw	p. 259
Strong-Drive® PPSD Sheathing-to-CFS Screw	p. 276	WSC Wood Screw	p. 273
Strong-Drive® WSV Subfloor Screw	p. 267	PHSS Wood Screw	p. 273
Deck-Drive™ DCU Composite Screw	p. 265	WSFLRV Wood-to-CFS/Aluminum Screw	p. 283
Deck-Drive™ DSV Wood Screw	p. 256	WSHL Subfloor Screw	p. 270
Deck-Drive™ DWP Wood SS Screw	p. 257	CBSDQ Sheathing-to-CFS Screw	p. 281
Deck-Drive™ DHPD Hardwood Screw	p. 257	DWC Drywall Screw	p. 270
Deck-Drive™ DCSD Composite-to-Steel Screw	p. 266	DWF Drywall-to-CFS Screw	p. 282
Trim-Head Screw: Type 17 Point	p. 259	DWFSD Drywall-to-CFS Screw	p. 282
Trim-Head Screw: Sharp Point	p. 258		

System Options	Model No.
DeWalt® 2,500 rpm screwdriver motor	PROSDDD25K
Makita® 2,500 rpm screwdriver motor	PROSDDM25K
Makita® 3,500 rpm screwdriver motor	PROSDDM35K
Parts	Model No.
PRO300S Attachment only	QDPR0300SG2
PRO200 Attachment only	QDPR0200G2
Replacement PRO300S attachment mandrel	PMANDREL75
Replacement PRO200 attachment mandrel	PMANDREL65

PROCCS+ Multi-Purpose Combo System

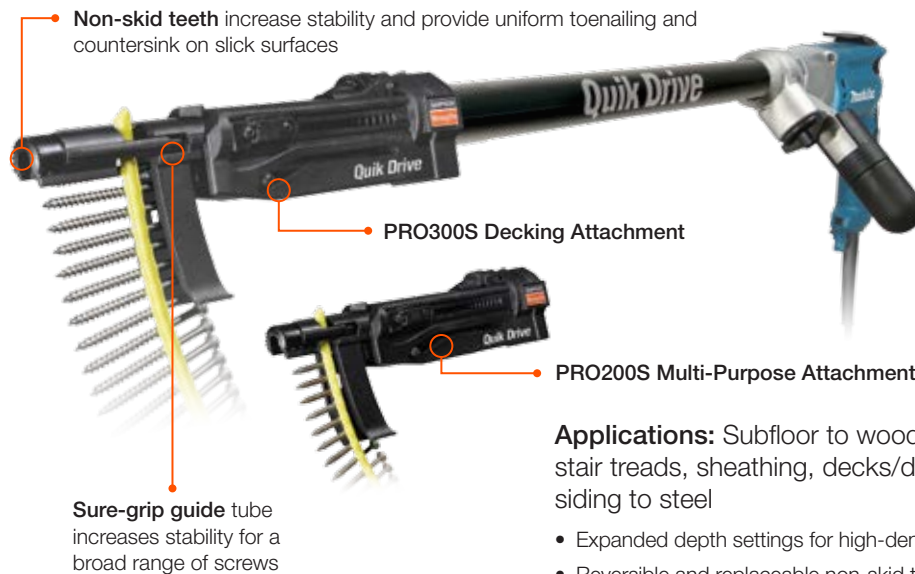

Applications: Subfloor to wood or steel, wall plates, stair treads, sheathing, decks/docks, fiber-cement siding to steel

- Expanded depth settings for high-density flooring materials
- Reversible and replaceable non-skid teeth
- Sure-grip guide tube increases stability for a broad range of screws
- The patented curved collation strips (U.S. Patent 7,051,875) hold the screws up and away from the work surface, making moving and positioning the tool easier. They are also pointed on the inserted end to simplify loading.

Limited lifetime warranty on attachment and extension, 1-year limited warranty on screw-driver motors (see specific manufacturer's warranty for more information)



The PROCCS+ Combo System includes:

- PRO300S Decking Attachment (also sold separately)
- PRO200S Multi-Purpose Attachment (also sold separately)
- Extension for stand-up driving
- Choice of DeWalt® or Makita® screwdriver motors
- Screw quiver for keeping screws at your fingertips
- Rugged tool case to protect your equipment on the jobsite

PROCCS+ Combo System

C-F-2017 © 2017 SIMPSON STRONG-TIE COMPANY INC.

Drive These Collated Screws			
Strong-Drive® WSNTL Subfloor Screw	p. 268	Bugle-Head Wood Screw	p. 259
Strong-Drive® WSV Subfloor Screw	p. 267	PHSS Wood Screw	p. 273
Deck-Drive™ DCU Composite Decking	p. 265	WSC Wood Screw	p. 273
Deck-Drive™ DWP Wood SS Screw	p. 257	WSFLRV Wood-to-CFS/Aluminum	p. 283
Deck-Drive™ DHPD Hardwood Decking	p. 257	WSHL Subfloor Screw	p. 270
Deck-Drive™ DCSD Composite Decking	p. 266	Strong-Drive® PPSD Sheathing-to-CFS	p. 276
Trim-Head Screw: Type 17 Point	p. 259	MTH Wood Underlayment Screw	p. 271
Trim-Head Screw: Sharp Point	p. 258	CBSDQ Sheathing-to-CFS Screw	p. 281

System Options	Model No.
DeWalt® 2,500 rpm screwdriver motor	PROCCS+D25K
Makita® 2,500 rpm screwdriver motor	PROCCS+M25K
Parts	Model No.
PRO300S Attachment only	QDPRO300SG2
PRO200S Attachment only	QDPRO200SG2
Replacement attachment mandrel	PMANDREL75

For more information on screwdriver motors and RPM recommendations per application, see pp. 244-245.

PROCGB Underlayment/Backerboard Combo System

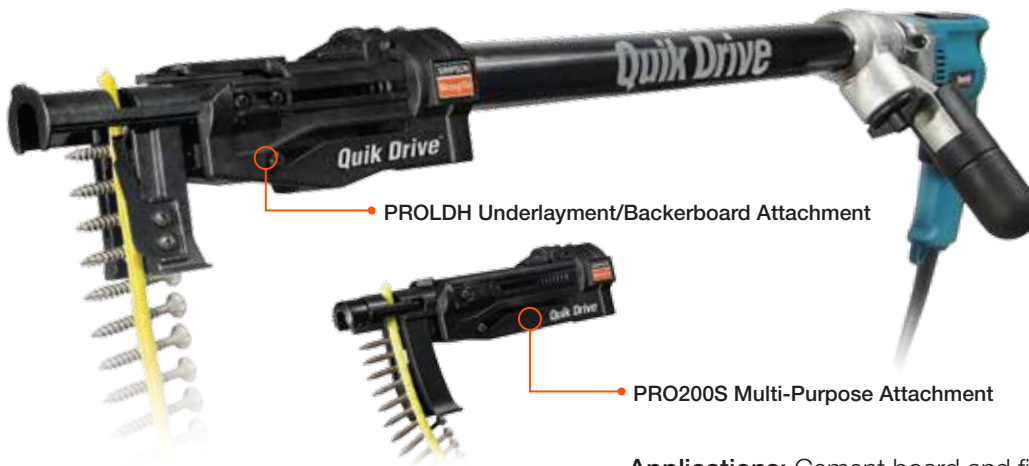

PROLDH Underlayment/Backerboard Attachment

PRO200S Multi-Purpose Attachment

Applications: Cement board and fiber-cement board underlayment to wood or steel, backerboard to wood or steel, gypsum panel to wood or steel

- PRO200S attachment is ideal for gypsum panel
- Extension allows stand-up driving
- Compact body for reduced weight and easy handling

Limited lifetime warranty on attachment and extension, 1-year limited warranty on screw-driver motors (see specific manufacturer's warranty for more information)



The PROCGB Combo System includes:

- PROLDH Underlayment/Backerboard Attachment (also sold separately)
- PRO200S Multi-Purpose Attachment (also sold separately)
- Auto-feed attachment
- Extension for stand-up driving
- Makita® screwdriver motor
- Screw quiver for keeping screws at your fingertips
- Rugged tool case to protect your equipment on the jobsite

PROCGB Combo System

Drive These Collated Screws

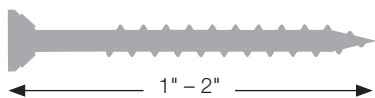

CB3BLG Fiber-Cement Board Screw	p. 260
CB3BLGHL Cement Board Screw	p. 260
CBSDQ Sheathing-to-CFS Screw	p. 281
DWC Drywall Screw	p. 270
DWF Drywall-to-CFS Screw	p. 282
DWFSD Drywall-to-CFS Screw	p. 282
MTH Wood Underlayment Screw	p. 271

System Options	Model No.
Makita® 2,500 rpm screwdriver motor	PROCGBM25K
Parts	Model No.
PROLDH Attachment only	QDPROLDHG2
PRO200S Attachment only	QDPRO200SG2
Replacement attachment mandrel (QDPROLDHG2)	PMANDREL65
Replacement attachment mandrel (QDPRO200SG2)	PMANDREL75

For more information on screwdriver motors and RPM recommendations per application, see pp. 244–245.

BSD200 Structural Steel-Decking Attachment



Innovative Precision Placement™ nosepiece allows for easy location of the holes in standing seam metal roofing clips

Applications: Steel decking and stitching; fastening for cold-formed steel; wide-valley nestable deck to structural steel members

Limited lifetime warranty on attachment and extension, 1-year limited warranty on screw-driver motors (see specific manufacturer's warranty for more information)

Drive These Collated Screws

1 1/4"

Strong-Drive® XL Large-Head Metal Screw	p. 277
---	--------

Parts	Model No.
Attachment only	QDBSD200G2
Replacement 5/16" hex bit	BITHEXLB516LG
Replacement mandrel with 5/16" hex bit	BPHXLBGGP516G2

BSD200 Attachment

BGP300 Metal-Roofing/Siding Attachment



Applications: Metal roofing and siding; exposed-fastener metal roofing to wood; metal siding to wood

Limited lifetime warranty on attachment and extension, 1-year limited warranty on screw-driver motors (see specific manufacturer's warranty for more information)

Drive These Collated Screws with EPDM-Backed Washers

3/4" - 3"

HJ Metal Roofing/Siding Panel Screw	p. 261
HG Metal Roofing/Siding Panel Screw	p. 261

Parts	Model No.
Attachment with 16" extension	QDBGP300G2K
Attachment with 16" extension and flat profile guides	QDBGP75KE
Replacement mandrel with 1/4" hex bit	BPHXLBGGP14G2
Replacement mandrel with 5/16" hex bit	BPHXLBGGP516G2

BGP300 Attachment

PRO200 Drywall Attachment



Applications: Drywall to wood or steel

Drive These Collated Screws

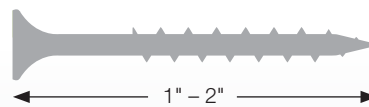

DWC Drywall Screw	p. 270
DWHL Drywall Screw	p. 271
DWF Drywall-to-CFS Screw	p. 282
DWFSD Drywall-to-CFS Screw	p. 282

Parts	Model No.
Attachment only	QDPRO200G2
Replacement mandrel	PMANDREL65

Limited lifetime warranty on attachment and extension, 1-year limited warranty on screw-driver motors (see specific manufacturer's warranty for more information)

PRO200 Attachment

PRO200S Multi-Purpose Attachment



Applications: Subfloor to wood or steel, sheathing, fiber-cement siding to steel, gypsum panel to wood or steel

Drive These Collated Screws

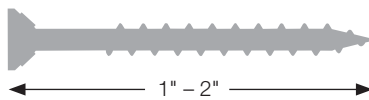

Strong-Drive® WSNTL Subfloor Screw	p. 268	DWC Drywall Screw	p. 270
Strong-Drive® WSV Subfloor Screw	p. 267	DWF Drywall-to-CFS Screw	p. 282
WSHL Subfloor Screw	p. 270	DWFSD Drywall Screw	p. 282
WSC Wood Screw	p. 263	CBSDQ Sheathing-to-CFS Screw	p. 281
FHSD Wood-to-CFS Screw	p. 283	MTH Wood Underlayment Screw	p. 271

Parts	Model No.
Attachment only	QDPRO200S
Replacement mandrel	PMANDREL75

Limited lifetime warranty on attachment and extension, 1-year limited warranty on screw-driver motors (see specific manufacturer's warranty for more information)

PRO200S Attachment

PRO250 Subfloor Attachment



Applications: Subfloor to wood or steel

Drive These Collated Screws			
Strong-Drive® WSNTL Subfloor Screw	p. 268	WSFLRV Wood-to-CFS/ Aluminum Screw	p. 283
Strong-Drive® WSV Subfloor Screw	p. 267	WSC Wood Screw	p. 273
Strong-Drive® PPSD Sheathing-to-CFS Screw	p. 276	PHSS Wood Screw	p. 273
Deck-Drive™ DSV Wood Screw	p. 256	Trim-Head Screw: Type 17 Point	p. 259
Deck-Drive™ DCSD Composite-to-Steel Screw	p. 266	DWC Drywall Screw	p. 270
WSHL Subfloor Screw	p. 270	DWFS Drywall Screw	p. 282
CBSDQ Sheathing-to-CFS Screw	p. 281		

Parts	Model No.
Attachment only	QDPRO250G2
Replacement mandrel	PMANDREL75

Limited lifetime warranty on attachment and extension, 1-year limited warranty on screw-driver motors (see specific manufacturer's warranty for more information)

PRO250 Attachment

PRO250DW Drywall Attachment



Applications: Fasten drywall to wood or steel

Drive These Collated Screws	
DWC Drywall Screw	p. 270
DWHL Drywall Screw	p. 271
DWFS Drywall Screw	p. 282

Parts	Model No.
Attachment only	QDPRO250DWG2
Replacement mandrel	PMANDREL75

Limited lifetime warranty on attachment and extension, 1-year limited warranty on screw-driver motors (see specific manufacturer's warranty for more information)

PRO250DW Attachment

PRO300S Decking Attachment

Non-skid teeth are reversible and replaceable



Applications: Decking on decks and docks, subfloor to wood or steel, wall plates, stair treads, sheathing, fiber-cement siding to steel

Drive These Collated Screws	
Deck-Drive™ DSV Wood Screw	p. 256
Deck-Drive™ DWP Wood SS Screw	p. 257
Deck-Drive™ DHPD Hardwood Screw	p. 257
Deck-Drive™ DCU Composite Screw	p. 265
Strong Drive® WSNTL Wood Screw	p. 267
Strong Drive® WSV Subfloor Screw	p. 267
Trim-Head Screw: Type 17 Point	p. 259
Trim-Head Screw: Sharp Point	p. 258
Bugle-Head Wood Screw	p. 259
CBSDQ Sheathing-to-CFS Screw	p. 281

Parts	Model No.
Attachment only	QDPRO300SG2
Replacement mandrel	PMANDREL75

Limited lifetime warranty on attachment and extension, 1-year limited warranty on screw-driver motors (see specific manufacturer's warranty for more information)

PRO300S Attachment

PROHSD60 Wood-to-Steel Fastening Attachment



Applications: Truck beds and trailer flooring to steel, wood nailers to structural steel

Drive These Collated Screws	
Strong-Drive® TB Wood-to-Steel Screw	p. 274
Strong-Drive® PPSD Sheathing-to-CFS Screw	p. 276

Parts	Model No.
Attachment only	QDHSD60
Replacement mandrel	PMANDREL75

Limited lifetime warranty on attachment and extension, 1-year limited warranty on screw-driver motors (see specific manufacturer's warranty for more information)

PROHSD60 Attachment

PROHSD75 Wood-to-Steel Fastening Attachment



Applications: Truck beds and trailer flooring to steel, wood nailers to structural steel

Drive These Collated Screws

Strong-Drive® TB Wood-to-Steel Screw	p. 274
Strong-Drive® PPSD Sheathing-to-CFS Screw	p. 276

Parts	Model No.
Attachment only	QDHSD75
Replacement mandrel	PMANDREL75

Limited lifetime warranty on attachment and extension, 1-year limited warranty on screw-driver motors (see specific manufacturer's warranty for more information)

PROHSD75 Attachment

PROHX14 Metal Roofing/Siding Attachment



Applications: Exposed-fastener metal roofing to wood, metal siding to wood

Features:

- Strip collation enables auto-feed fastening of screws with EPDM-backed washers
- Precise depth adjustment prevents over- and under-driving
- Drives fasteners for steel-to-wood framing
- Designed to eliminate skipped screws, reducing screw waste
- Easy loading keeps work moving

Drive These Collated Screws

HG Metal Roofing/Siding Panel Screw (galvanized and painted with washer)	p. 261
HG Metal Roofing/Siding Panel Screw (galvanized without washer)	p. 261

For information on Quik Drive screw coatings, see pp. 20–21. For more information on corrosion, see pp. 17–18.

Parts	Model No.
Attachment only	QDPROHX14G2
Replacement mandrel	BPHXLB14G2
Replacement bit	BITHEXLB14
Replacement noseguard	PNOSEGUARD-5

Limited lifetime warranty on attachment and extension, 1-year limited warranty on screw-driver motors (see specific manufacturer's warranty for more information)

PROHX14 Attachment

PROHX516 Steel-to-Steel Fastening Attachment



Applications: Cold-formed steel framing, steel decking to structural steel members

Features:

- Compact body for reduced weight and easy handling
- Slim profile allows driving in corners
- Tough reliability for targeted applications

Limited lifetime warranty on attachment and extension, 1-year limited warranty on screw-driver motors (see specific manufacturer's warranty for more information)

Drive These Collated Screws

Strong-Drive® Self-Drilling X Metal Screw	p. 278
---	--------

Parts	Model No.
Attachment only	QDPROHX516G2
Replacement mandrel	BPHX516G2

For applications where maximum torque is preferred, see the Hitachi® screwdriver motor HIW8VB2 on p. 244 (sold separately).

PROLDH Underlayment/Backerboard Attachment



Applications: Cement board and fiber-cement board underlayment/backerboard to wood or steel

Drive These Collated Screws

CB3BLG Fiber-Cement Board Screw	p. 260
CB3BLGHL Cement Board Screw	p. 260

Parts	Model No.
Attachment only	QDPROLDHG2
Replacement mandrel	PMANDREL65

Limited lifetime warranty on attachment and extension, 1-year limited warranty on screw-driver motors (see specific manufacturer's warranty for more information)

PROPH Cold-Formed Steel Framing Attachment



Applications: Fasten cold-formed steel framing

Features:

- Compact body for reduced weight and easy handling
- Slim profile allows driving in corners
- Tough reliability for targeted applications

Drive These Collated Screws

Strong-Drive® FPHSD Framing-to-CFS Screw	p. 275
Strong-Drive® PHSD Framing-to-CFS Screw	p. 275

Description	Model No.
Attachment only	QDPROPHG2
Replacement mandrel	PMANDREL65
Noseguard	PNOSEGUARD-5

Limited lifetime warranty on attachment and extension, 1-year limited warranty on screw-driver motors (see specific manufacturer's warranty for more information)

PROPH Attachment

PRORF Roofing Tile Attachment



Applications: Roofing tiles to wood

Drive These Collated Screws

WSCD Roofing Tile Screw	p. 264
WSCT Roofing Tile Screw	p. 264
SSWSCB Roofing Tile Screw	p. 264

Parts	Model No.
Attachment only	QDPRORFG2
Replacement mandrel	PMANDREL75

Limited lifetime warranty on attachment and extension, 1-year limited warranty on screw-driver motors (see specific manufacturer's warranty for more information)

PRORF Attachment

PRO300SRF Roofing Tile Attachment



Applications: Roofing tiles to wood

Drive These Collated Screws	
WSCD Roofing Tile Screw	p. 264
WSCT Roofing Tile Screw	p. 264
SSWSCB Roofing Tile Screw	p. 264

Parts	Model No.
Attachment only	QDPRO300SRFG2
Replacement mandrel	PMANDREL75

Limited lifetime warranty on attachment and extension, 1-year limited warranty on screw-driver motors (see specific manufacturer's warranty for more information)

PRO300SRF Attachment

PROSDX150 Steel-Decking Attachment



Applications: Steel deck fastening to structural steel members; narrow-valley nestable and interlocking steel decking; side-lap stitching

Drive These Collated Screws	
Strong-Drive® Self-Drilling X Metal Screw	p. 278
Strong-Drive® XM Medium-Head Metal Screw	p. 277

Parts	Model No.
Attachment only	QDPROSDX150G2
Replacement 5/16" hex bit	BITHEXLB516LG
Replacement hex mandrel with 5/16" hex bit	BPHXLBSDG2

Limited lifetime warranty on attachment and extension, 1-year limited warranty on screw-driver motors (see specific manufacturer's warranty for more information)

PROSDX150 Attachment

PROPP150 Metal Roofing Attachment



Innovative Precision Placement™ nosepiece allows for easy location of the hole in the roofing panel clip to drive the screw

Applications: Panel clips for standing-seam-roofing, steel decking to structural steel members, panel flanges for snap-and-seam metal roofing

Drive These Collated Screws	
Strong-Drive® FPHSD Framing-to-CFS Screw	p. 275
PC Standing-Seam-Roofing Panel Clip Screw	p. 263
PCSD Standing-Seam-Roofing Panel Clip Screw	p. 280
Strong-Drive® Self-Drilling X Metal Screw	p. 278

Parts	Model No.
Attachment only	QDPROPP150G2
Replacement mandrel	PMANDREL10
Replacement hex bit and mandrel	BPHXLBPPG2

Limited lifetime warranty on attachment and extension, 1-year limited warranty on screw-driver motors (see specific manufacturer's warranty for more information)

PROPP150 Attachment

Quik Drive® — Screwdriver Motors

Quik Drive® Systems are Available with a Variety of Screwdriver Motors

The information below will aid in the selection of the right tool for the intended application. Not all motors are available with all systems; reference the appropriate systems page for available options.

Screwdriver Motors Sold in Quik Drive Systems

				
Description*	DeWalt® 2,000 rpm 6.5 amp 164 in./lb. peak torque*	DeWalt® 2,500 rpm 6.5 amp 132 in./lb. torque*	Hitachi® 1,700 rpm 6.5 amp 215 in./lb. peak torque*	Makita® 2,500 rpm 6.5 amp 133 in./lb. torque*
Features	Adjustable torque	Multi-application versatility	Increased power for high-torque applications	Multi-application versatility
Quik Drive Model Number	DW267QD	DW276QD	HIW8VB2	MAFS2500

Available in these Quik Drive Systems

PRO200	—	PRO200G2D25K	—	PRO200G2M25K
PRO250	—	PRO250G2D25K	—	PRO250G2M25K
PROCCS+	—	PROCCS+D25K	—	PROCCS+M25K
PROCGB	—	—	—	PROCGBM25K
PROLDH	—	—	—	PROLDHG2M25K
PROPP150	PROPP150G2DATK	—	—	PROPP150G2M25K
PROSDX150	PROSDX150G2DATK	—	—	—
BSD200	QDBSD200G2DATK	—	—	—
PRORF	—	—	—	PRORFG2M25K
PROSDD	—	PROSDD25K	—	PROSDDM25K
PRO300SRF	—	—	—	PRO300SRFG2M25K
PRO300S	—	PRO300SD25K	—	PRO300SM25K
PROHSD60	—	—	PROHSD60H17K	PROHSD60M25K
PROHSD75	—	—	PROHSD75H17K	—
PROHX516	—	—	—	PROHX516M25K
PRO200S	—	PRO200SG2D25K	—	—

*This information provided by screwdriver motor manufacturers. All screwdriver motors may also be purchased separately using the tool model number.

Quik Drive® — Screwdriver Motors



Screwdriver Motors Sold in Quik Drive® Systems

			
Description*	Makita 3,500 rpm 6.5 amp 107 in./lb. peak torque*	Makita 2,500 rpm 6 amp Adjustable torque*	Makita 1,000–2,000 rpm 4.6 amp (2 speeds) 177 in./lb. peak torque*
Features	Increased speed for low-torque applications	Six torque settings, ideal for steel-framing applications	Two speeds for heavy-gauge steel applications
Quik Drive Model Number	MAFS3500	MAFS2701	MA6807Z
Available in these Quik Drive Systems			
PRO200	—	—	—
PRO250	PRO250G2M35K	—	—
PROCCS+	—	—	—
PROCGB	—	—	—
PROLDH	—	—	—
PROPP150	—	—	—
PROSDX150	—	—	—
BSD200	—	—	—
PRORF	PRORFG2M35K	—	—
PROSDD	PROSDDM35K	—	—
PRO300SRF	PRO300SRFG2M35K	—	—
PRO300S	PRO300SM35K	—	—
PROHSD60	—	—	PROHSD60MVK
PROHSD75	—	—	PROHSD75MVK
PROHX516	—	PROHX516MATK	—
PRO200S	—	—	—

*This information provided by screwdriver motor manufacturers. All screwdriver motors may also be purchased separately using the tool model number.

Screwdriver Motors — Sold Separately

This tool is not available in a system, and must be ordered separately.

	Description	Features	Tool Model No.
	Makita 6,000 rpm 6.0 amps	Maximum speed for drywall applications	MAFS6200
	Fein 1,700 rpm	Cordless screwdriver motor	FEASC63
	DeWalt 4,400 rpm	Brushless, cordless screwdriver motor	DCF620D2G2

Quik Drive® — Auto-Feed Screw Driving Systems



Quik Drive® Adjustable Countersink Feature

The adjustable countersink on Quik Drive® auto-feed attachments allows the user to dial-in fastener penetration to match the material and application. Once the countersink depth is set, the driver bit automatically disengages from the head of the screw when the desired penetration is achieved, preventing over-driving. Screws can be driven to the right depth every time without the user having to slow down to check each fastener, making for faster work and more consistent results.

Some things to consider when using the countersink feature:

- Test and adjust the countersink depth using a scrap piece of lumber.
- Stainless-steel screws are softer than carbon steel screws. Therefore, care should be taken to set the countersink adjustment wheel to a drive depth that will not over-drive the screw during installation. Over-driving stainless-steel screws can cause breakage.
- For more information, visit strongtie.com/quikdrivevideos

Screwdriver Motor RPM Recommendations

Simpson Strong-Tie offers a large selection of screwdriver motors for Quik Drive auto-feed screw driving systems. It is important to select a motor with RPM specifications that suit the intended application(s) to ensure the best results. See the full selection of screwdriver motors on pp. 244–245.

Screwdriver Motor RPM Recommendations Per Application

Applications	Cordless	1,700 rpm	2,500 rpm	3,500 rpm	6,000 rpm	2,000 rpm Adjustable Torque	2,500 rpm Adjustable Torque	1,000-2,000 rpm 2 Speed
Subfloor and Sheathing	—	—	Better	Best	—	—	—	—
Decks/Docks	—	Better	Best	Better	—	—	—	—
Drywall	—	—	Good	Better	Better	—	—	—
Fiberglass-Mat Gypsum Sheathing	—	—	Good	Better	Better	—	—	—
Fiber-Cement Siding	—	Good	Best	Good	—	—	—	—
Tile Roofing	—	—	Best	Better	—	—	—	—
Metal Roofing and Siding	Good	—	Best	Better	—	—	—	—
Steel Framing	Good	Good	Best	Good	—	Good	Good	—
Steel Decking	—	—	—	—	—	Best	Better	—
Steel Stitching	—	—	Good	—	—	Best	Best	—
Underlayment	Good	Better	Best	Better	—	—	—	—
Truck and Trailer Beds	—	Best	Good	—	—	—	—	Best
Remodeling and General Purpose	Good	—	Best	Better	—	—	—	—

Quik Drive® — Adapters

Adapters for Most Popular Screwdriver Motors

Screwgun	QD Adapter	Screwgun	QD Adapter	Screwgun	QD Adapter
Bosch®		Hilti®		Fein®	
GSR645TE	BOA1G2	ST 18	HT18G2	ASCS 4.8 (cordless)	FEA1G2
SG25	BOA1G2	ST 1800-A18 (cordless)	HT18G2	ASCS 6.3 (cordless)	FEA1G2
SG45	BOA1G2	SD2500	HTAG2	ASCT 14 (cordless)	FEA1G2
SG250	BOA1G2	SD4500	HTAG2	ASCT 18 (cordless)	FEA1G2
SG450	BOA1G2	SD5000 (cordless)	HTAG2	Hitachi®	
DeWalt®		SF4000 (cordless)	HTAG2	W6VM	HIAG2
252	DWAG2	Makita®		W6V3	HIAG2
254	DWAG2	6807	MAA6807G2	W6V4	HIAG2
255	DWAG2	6820V	MAAG2	W6VA4	HIAG2
257	DWAG2	6821	MAAG2	W6VB2	HIAG2
260	DWAG2	6823	MAAG2	W6VB3	HIAG2
265	DWAG2	6824	MAAG2	W8VB	HIAG2
266	DWAG2	6825	MAAG2	W8VB2	HIAG2
267	DWA3G2	6827	MAAG2	WH18DMR	HIA1G2
268	DWA3G2	6828	MAAG2	Milwaukee®	
272	DWAG2	6758	MAAG2	6701-20	MIAG2
274	DWAG2	6760	MAAG2	6702-20	MIAG2
275	DWAG2	FS2200	MAA3G2	6707-20	MIAG2
276	DWAG2	FS2500	MAA3G2	6708-21	MIAG2
277	DWAG2	FS4200	MAA3G2	6740-20	MIAG2
281	DWAG2	FS6200	MAA3G2	6741-1	MIAG2
284	DWAG2	LXSF01 (cordless)	MAA3G2	6742-20	MIAG2
520 (cordless)	DWA1G2	6832	ADM31DG2	6743-20	MIAG2
DCF620 (cordless)	DWA7G2	6833D	ADM31DG2	6743-50	MIAG2
DC825 (cordless)	DWA2G2	FR440D	ADM31DG2	6743-55	MIAG2
825 (cordless)	DWAG2	BFR750 (cordless)	ADM31DG2	6745-1	MIAG2
827 (cordless)	DWAG2	BTD140 (cordless)	MAA1G2	6746-1	MIAG2
835 (cordless)	DWAG2	BTD141 (cordless)	MAA1G2	6755-4	MIAG2
845 (cordless)	DWAG2	BTD144 (cordless)	MAA1G2	6758	MIAG2
855 (cordless)	DWAG2	BTD142HW (cordless)	MAA1G2	6760	MIAG2
DCF885 (cordless)	DWA6G2	BFS450 (cordless)	MAA2G2	6790-1	MIAG2
DCF886 (cordless)	DWA6G2	LXDT04 (cordless)	MAA6G2	6790-20	MIAG2
895 (cordless)	DWA4G2			6791-20	MIAG2
969 (cordless)	DWA3G2			2653	MIA1G2

Quik Drive — Swivel Adapters

- Rotates 360° without having to detach the tool from motor
- Allows the use of one hand to rotate tool
- Easily rotate screws out of the way for corner applications

Screwgun	QD Adapter
DeWalt®	
252	DWASWG2
254	DWASWG2
255	DWASWG2
257	DWASWG2
260	DWASWG2
265	DWASWG2
266	DWASWG2
267	DWASWG2
268	DWASWG2
272	DWASWG2
274	DWASWG2
275	DWASWG2
277	DWASWG2
276	DWASWG2
281	DWASWG2
284	DWASWG2
DCF620	DWA7G2
Hilti®	
SD4500	HTASWG2
Makita®	
X5F03	MAA7G2

Quik Drive® — Replacement Parts

Part	Model No.
Bit key for Quik Drive tools	BITKEY
Bit pack — 3 ea. Phillips-drive bit	BIT2P-RC3
Bit pack — 3 ea. #2 square-drive bit	BIT2S-RC3
Bit pack — 3 ea. #2 undersized square-drive bit	BIT2SU-RC3
Bit pack — 3 ea. #3 square drive	BIT3S-RC3
Bit pack — 3 ea. #3 undersize square drive	BIT3SU-RC3
Bit pack — 10 ea. #2 Phillips-drive bit	BIT2P-RC10
Bit pack — 10 ea. #2 square-drive bit	BIT2S-RC10
Bit pack — 10 ea. #2 undersize square-drive bit	BIT2SU-RC10
Bit pack — 10 ea. #3 square-drive bit	BIT3S-RC10
Bit Pack — 10 ea. #3 undersize square-drive bit	BIT3SU-RC10
Bit Pack — 10 ea. T-20 6-lobe drive bit	BITTX20-RC10
Bit Pack — 3 ea. T-20 6-lobe drive bit	BITTX20-RC3
Bit Pack — 10 ea. T-25 6-lobe drive bit	BITTX25-RC10
Bit pack — 3 ea. T-25 6-lobe drive bit	BITTX25-RC3
Driver bit, hex 5/16"	BITHEX516
Driver bit, lobular, hex 5/16"	BITHEXLB516LG
Driver bit, lobular, hex head, 1/4"	BITHEXLB14
Mandrel, BSD, with lobular 5/16" driver bit for QDBSD200 tool	BPHLXBBGP516G2
Mandrel, BGP, with lobular 5/16" driver bit for QDBGP300 tool	BPHLXBBGP516G2
Leafspring, HSD, HX14 attachments	QDLEAFSPRING
Leafspring, HX516, PH, LDH, PP150, SD150 attachments	QDLEAFSPRING2
Mandrel, QDA158NS attachment	PMANDREL158
Mandrel, BGP, with lobular 1/4" driver bit	BPHLXBBGP14G2
Mandrel, BGP, with lobular 5/16" driver bit	BPHLXBBGP516G2
Driver bit, lobular, hex 5/16" for PROPPSD tool	BITHEXLB516LG
Mandrel, 5 1/2"	PMANDREL55
Mandrel, 6"	PMANDREL6
Mandrel, 6 1/2"	PMANDREL65-RC
Mandrel, 7 1/2"	PMANDREL75-RC
Mandrel, 10"	PMANDREL10
Mandrel, 5/16" hex with driver bit for PP150 series attachment	BPHLXBBGP2
Mandrel, HX516 attachment, with 5/16" driver bit	BPHX516G2
Mandrel, 5/16" hex with driver bit for SDX150 series attachment	BPHLXBSG2



QDLEAFSPRING2



PMANDREL75-RC

Drive Types and Replacement Driver Bits

It is necessary to use the right driver bit to ensure optimum results with a Quik Drive system. The bit(s) included in each box of Quik Drive screws should be sufficient to drive the entire box, however variations in materials and driving techniques can shorten driver-bit life. Replacement bits are available in Bit Packs; reference the label on the bit included in the box or the box label to ensure correct driver-bit selection (see table above for Bit Pack quantities and model numbers).

Drive Type/Size	Bit	Description
#2 square drive	R2	BIT2S — for most screws with #2 recess and interior-grade coating
#2U (#2 undersized)	R2U	BIT2SU — for most screws with #2 recess and exterior-grade coating
#3 square drive	R3	BIT3S — for most screws with #3 recess and interior-grade coating
#3U (#3 undersized)	R3U	BIT3SU — for most screws with #3 recess and exterior-grade coating
#2 phillips		BIT2P — for all Quik Drive screws with phillips recess
1/4" lobular hex drive	P2	BITHEXLB14 — for most screws with 1/4" lobular hex drive
5/16" lobular hex drive		BITHEXLB516 — for most screws with 5/16" lobular hex drive
T-20 6-lobe		BITTX20 — for Quik Drive systems with T-20 6-lobe drive
T-25 6-lobe		BITTX25 — for Quik Drive systems with T-25 6-lobe drive



BIT3S-RC10

C-F-2017 © 2017 SIMPSON STRONG-TIE COMPANY INC.

Quik Drive® — Accessories

Accessories	Model No.
Adjusting arm, BGP300G2 (profile guide not included)	PADJARMBGP300G2
Feed pawl, 250, 200S, 300S attachments	PFEEDPAWL
Feed pawl, twist lock for SDS, 200 attachments	PFEEDPAWLTL
Feed pawl, HSD attachments	PFEEDPAWL3
Feed pawl, HX, PH, LDH, PROPP attachments	PFEEDPAWL2
Feed Pawl PP, PH, SD attachments	PFEEDPAWL5

Replacment Parts	Model No.
Case, PRO kits	TOOLCASE-LG
Deck clip, PRO300S, PRO200S, PRO250	QDDECKCLIP-RC
Extension, 16" (short), G2 series	QDEXTG2-16
Extension, 20" (standard), G2 series	QDEXTG2
Extension, 22" (long), G2 series	QDEXTG2-22
Extension replacement handle, G2 Series	G2HANDLE
Noseclip, 250, 200S, 300S attachments	PNOSECLIP
Noseguard, HX516 attachment	PNOSEGUARD-5
Profile guide, 5V	PPROFILEGUIDE5V
Profile guide, AG panel ¾" Rib	PPROFILEGUIDE32
Profile guide, corrugated ½" H x 2¾" W	PPROFILEGUIDE22
Profile guide, corrugated ⅞" H x 2¾" W	PPROFILEGUIDE23
Profile guide, flat	PPROFILEGUIDE11
Profile guide, J Rib / 4-Rib	PPROFILEGUIDE33
Profile guide, Maxi Rib	PPROFILEGUIDE34
Screw quiver, worn on belt, carries up to 500 screws	QUIVER



QDEXTG2-16 (QDEXTG2 and QDEXTG2-22 similar)



PFEEDPAWL



PNOSECLIP



QUIVER



QDDECKCLIP-RC

Quik Drive® — Schematics and Troubleshooting

System Components

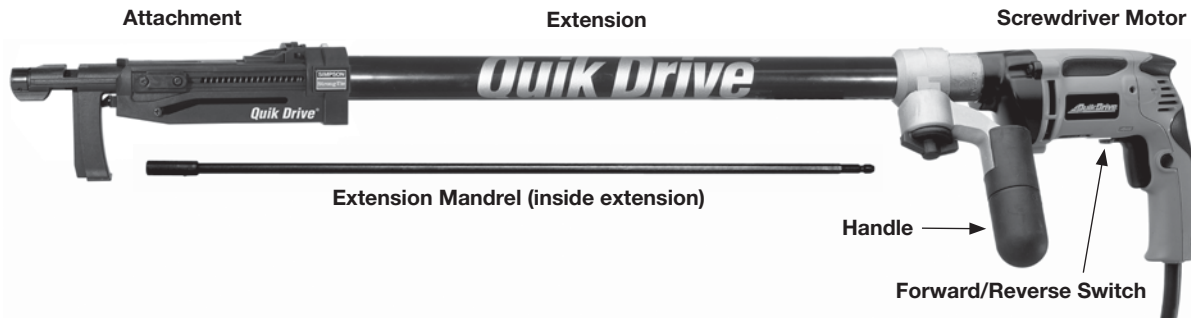

Schematic

Attachment

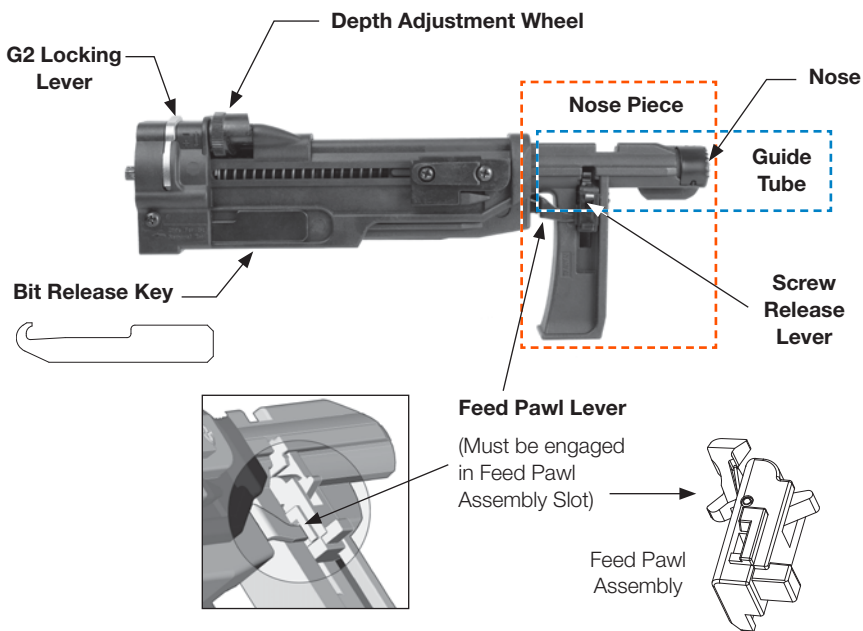

Bit Release Slot



Mandrel
(found inside attachment)



Hex Mandrel
(found inside attachment)

Part No.:
BPHXLBBGP14G2 Attachment: QDBGP300G2K
BPHXLBBGP516G2 Attachment: QDBGP300G2K
BPHX516G2 Attachment: QDPROHX516G2
BPHXLBPPG2 Attachment: QDPROPP150G2
PMANDREL10 Attachment: QDPROPP150G2
PMANDREL65 Attachments: QDPRO200G2, QDPROLDHG2, QDPROPHG2
PMANDREL75 Attachments: QD200SG2, QDPRO250G2, QDPRO300SG2, QDPRORFG2, QDPRO300SRFG2, QDHSD60, QDHSD75
BPHXLBSDG2 Attachment: QDPROSD150G2

Troubleshooting Guide

Simpson Strong-Tie® Quik Drive® tools are easy to use. As with any power tool, there are a few basic things to remember for best performance.

Problem	Solution
Screws won't drive. They spin for a second, then lay over on their side. Little or no penetration.	Make sure the screwdriver motor is not in reverse.
Screws won't drive completely. They go down about halfway, then the bit spins out.	Check to be sure you are using the correct bit for the type of screws you are driving. Check for bit wear. It may be time to install a new bit. Push harder when driving.
Screws won't drive completely. They are almost completely driven but won't countersink completely.	Check the depth adjustment on the attachment. Reset if necessary. You may have missed the substrate. Example: In flooring, this will occur if you miss the joist.
Screws don't advance properly causing tool to jam.	Use only Simpson Strong-Tie Quik Drive brand collated screws. Be sure the screw strip is inserted correctly — pointed end first. Lift the tool completely off the work surface after driving each screw. Don't drag screw strips on the work surface as you move to the next position. Be sure the feed pawl assembly is intact and feed lever is engaged. Avoid the use of wet or spray lubricants that may attract wood or drywall dust.

Quik Drive® — Warranty

Limited Warranty on Quik Drive® Tool

This Limited Lifetime Warranty applies to all Quik Drive tools and must be read in conjunction with the General Notes, Terms and Conditions of Sale, and Corrosion Resistance information contained in the current Quik Drive catalog and at strongtie.com/info, along with any information provided with a Simpson Strong-Tie Company Inc. (“Simpson”) product. Screwguns, screw driver motors and batteries that may be supplied with the Quik Drive tools are manufactured by others and are warranted only by their respective manufacturers. Simpson Strong-Tie warrants the Quik Drive tools to the original purchaser to be free from substantial defects in material, manufacturing, and design for the lifetime of the product, if properly stored, maintained and used. This Warranty does not cover normal wear and tear or any Quik Drive tool that was: (1) purchased other than from an authorized Simpson Strong-Tie dealer, retailer or distributor; (2) modified or altered; (3) used with any fasteners other than authentic Quik Drive fasteners; (4) improperly serviced; or (5) subject to negligence, excessive uses, or any use not in accordance with the printed materials provided with the Quik Drive tool as determined by Simpson Strong-Tie. Purchaser’s sole remedies are replacement or repair upon return to Simpson Strong-Tie with proof of purchase (shipping prepaid by purchaser). To obtain warranty service go to strongtie.com or contact Simpson Strong-Tie promptly at (800) 999-5099. The repaired or replaced Quik Drive tool is warranted under the terms of this Warranty.

SIMPSON DISCLAIMS ALL OTHER WARRANTIES, EXPRESS OR IMPLIED, INCLUDING BUT NOT LIMITED TO IMPLIED WARRANTIES OF MERCHANTABILITY AND FITNESS FOR A PARTICULAR PURPOSE. IN NO EVENT WILL SIMPSON BE LIABLE FOR INCIDENTAL, CONSEQUENTIAL, PUNITIVE OR SPECIAL DAMAGES OR DIRECT OR INDIRECT LOSS OF ANY KIND, INCLUDING BUT NOT LIMITED TO PROPERTY DAMAGE AND PERSONAL INJURY. SIMPSON’S ENTIRE LIABILITY IS LIMITED TO THE PURCHASE PRICE OF THE PRODUCT. SOME STATES DO NOT ALLOW LIMITATIONS ON IMPLIED WARRANTIES, OR THE EXCLUSION OR LIMITATION OF INCIDENTAL OR CONSEQUENTIAL DAMAGES, SO THE ABOVE LIMITATIONS AND EXCLUSIONS MAY NOT APPLY TO YOU. THIS LIMITED WARRANTY GIVES YOU SPECIFIC LEGAL RIGHTS, AND YOU MAY ALSO HAVE OTHER RIGHTS THAT VARY FROM STATE TO STATE.

Additional Quik Drive® Safety Warnings

- Keep work area clean and well lit.
- Do not operate Simpson Strong-Tie® Quik Drive® tools in dangerous environments. Do not expose tools to rain or use them in damp or wet locations. The use of Quik Drive tools can create sparks. Do not use in the presence of flammable liquids, dust or gases.
- Keep bystanders, children and visitors away while operating a Quik Drive tool. Distractions can cause accidents and serious bodily injury.
- Keep proper footing and balance at all times.
- Always use safety equipment, such as protective glasses, dust masks, non-skid safety shoes, safety harnesses hard hats and/or earplugs.

can be caught in moving parts and result in serious bodily injury. Be sure the power switch on a tool is in the off position before plugging in the tool. Do not carry tools with your finger on the switch.

Reduce Risk of Electrical-Related Accidents

- Guard against electrical shock. Prevent body contact with grounded surfaces.
- Never modify the tool power plug in any way. Always use a plug with a matching outlet. Use of proper, unmodified plugs and outlets reduces the risk of electric shock.
- Do not abuse the power cord. Never carry a tool by its cord or pull the cord to disconnect from an outlet or other receptacle. Keep cord away from heat, oil, sharp edges or moving parts. Replace damaged cord immediately. Damaged cords increase the risk of electrical shock.
- When operating a tool outside, use extension cords suitable for outdoor use.

Personal Safety

- Stay alert. Do not use a Quik Drive system while tired or under the influence of drugs, alcohol or medication. Use common sense when operating the tool. Inattention while operating Quik Drive system may result in serious bodily injury.
- Dress properly when using a Quik Drive system. Do not wear loose clothing or jewelry. Keep your hair, clothing and gloves away from moving parts. Loose clothes, long hair or jewelry

Quik Drive Tool Use and Care

- Do not force the Quik Drive tool. Use the correct tool for the application.
- When not in use, Quik Drive systems should be stored in a dry place and out of the reach of children and other untrained persons.
- Disconnect the plug from power source before making adjustments, changing accessories or storing tool.
- Maintain Quik Drive tools with care. Follow instructions for changing accessories.
- Regularly check for misalignment or binding of moving parts and other conditions that may affect operation.
- Use only accessories recommended by Simpson Strong-Tie Company Inc.
- Any repairs to electric tools should be performed by qualified personnel. Use only authorized parts.
- Do not use wet or spray lubricants on any Quik Drive parts that may attract wood, metal or drywall dust.



SIMPSON
Strong-Tie

Quik Drive

Less torque,
more driving.

Strong-Drive® WSV SUBFLOOR Screw



Collated Screws for the Quik Drive® System



The patented curved collation strips (U.S. Patent 7,051,875) hold the screws up and away from the work surface, making moving and positioning the tool easier. They are also pointed on the inserted end to simplify loading.

Application/Fastener/Tool Matrix 254

Collated Exterior Wood Screws

- Deck-Drive™ DSV WOOD Screw 256
- Deck-Drive™ DWP WOOD SS Screw 257
- Deck-Drive™ DHPD HARDWOOD Screw 257
- Trim-Head Screw — Sharp Point 258
- Trim-Head Screw — Type-17 Point 259
- Bugle-Head Wood Screw 259
- CB3BLG Fiber-Cement Board Screw 260
- CB3BLGHL Cement Board Screw 260
- HJ Metal Roofing/Siding Panel Screw 261
- HG Metal Roofing/Siding Panel Screw 261
- Color Guide for HJ 262
- PC Standing-Seam-Roofing Panel Clip Screw 263
- WSC Wood Screw 263
- SSWSCB Roofing Tile Screw 264
- WSCT Roofing Tile Screw 264
- WSCD Roofing Tile Screw 264

Collated Composite Decking Screws

- Deck-Drive™ DCU COMPOSITE Screw 265
- Deck-Drive™ DCSD COMPOSITE-TO-STEEL Screw 266

Collated Interior Wood Screws

- Strong-Drive® WSV SUBFLOOR Screw 267
- Strong-Drive® WSNTL WOOD Screw 267
- Strong-Drive® WSNTL SUBFLOOR Screw 268
- WSHL Subfloor Screw 270
- DWC Drywall Screw 270
- DWHL Drywall Screw 271
- MTH Wood Underlayment Screw 271
- PC Standing-Seam-Roofing Panel Clip Screw 272
- PHSS Wood Screw 273
- WSC Wood Screw 273
- WSCLT Wood Screw 273

Collated Metal Screws

- Strong-Drive® TB WOOD-TO-STEEL Screw 274
- Strong-Drive® PHSD FRAMING-TO-CFS Screw 275
- Strong-Drive® FPHSD FRAMING-TO-CFS Screw 275
- Strong-Drive® PPSD SHEATHING-TO-CFS Screw 276
- Strong-Drive® XL LARGE-HEAD METAL Screw 277
- Strong-Drive® XM MEDIUM-HEAD METAL Screw 277
- Strong-Drive® SELF-DRILLING X METAL Screw 278
- Steel Deck Diaphragm Calculator 279
- PCSD Standing-Seam-Roofing Panel Clip Screw 280
- CBSDQ Sheathing-to-CFS Screw 281
- DWF Drywall-to-CFS Screw 282
- DWFSD Drywall-to-CFS Screw 282
- FHSD Wood-to-CFS Screw 283
- WSFLRV Wood-to-CFS/Aluminum Screw 283



Application / Fastener / Tool Matrix

Application / Screw	Page	Suitable Systems/Attachments					
		PRO200S	PRO250	PRO300S	PRORF	PRO300SRF	PROLDH
Deck/Dock							
DCU234	265			✓			
DSVG212S	256		✓	✓			
DSVG3S	256			✓			
DSVR114S	256	✓					
DSVR158S	256	✓	✓				
DSVR2S	256	✓	✓	✓			
DSVR212S	256		✓	✓			
DSVR3S	256			✓			
DSVT114S	256	✓					
DSVT158S	256	✓	✓	✓			
DSVT2S	256	✓	✓	✓			
DSVT212S	256		✓	✓			
DSVT3S	256			✓			
DTHQ2S	259	✓	✓	✓			
DTHQ212S	259		✓	✓			
DTHQ3S	259			✓			
SS3DSC212BS	259		✓	✓			
SS3DSC212BS316	259		✓	✓			
SS3DSC3BS	259			✓			
SS3DSC3BS316	259		✓	✓			
SSDHPD212S	257			✓			
SSDTH2S	258	✓	✓	✓			
SSDTH212S	258		✓	✓			
SSDTH3S	258			✓			
SSDWP212S305	257		✓	✓			
SSDWP3S305	257			✓			
SSDWP212S316	257		✓	✓			
SSDWP3S316	257			✓			
Wood-to-Wood							
WSCG134S	263	✓	✓	✓			
WSNTLG2S	267	✓	✓	✓			
WSNTLG212S	267		✓	✓			
WSNTLG3S	267			✓			
WSNTLQ212S	267		✓	✓			
WSNTLQ3S	267			✓			
WSC114S-17	273	✓					
WSC112S	273	✓	✓	✓			
WSCLT134S	273	✓	✓	✓			
WSHL134S7	270	✓	✓	✓			
WSNTL134S	268	✓	✓	✓			
WSNTL2LS	268	✓	✓	✓			
WSNTL212S	268		✓	✓			
WSNTL3S	268			✓			
WSV134S	267	✓	✓	✓			
Underlayment							
CB3BLG114S	260						✓
CB3BLGHL114S	260						✓
CB3BLG158S	260			✓			✓
CB3BLGHL158S	260						✓
MTH114S	271	✓					
MTHZ1S	271	✓					
Fiber-Cement Siding-to-Steel							
CBSDQ158S	281	✓	✓				
CBSDQ214S	281		✓	✓			
Tile Roofing							
SSWSC2BS	264				✓	✓	
SSWSC134BS	264	✓	✓	✓	✓	✓	
SSWSC212BS	264				✓	✓	
WSCD212S	264				✓	✓	
WSCD3S	264					✓	
WSC212S	264				✓	✓	
Crating							
PHSS212S	273		✓	✓			
Truss-Ply Fastening							
WSNTL212S	268		✓	✓			
WSNTL3S	268			✓			

Collated Screws for the Quik Drive® System

C-F-2017 © 2017 SIMPSON STRONG-TIE COMPANY INC.



Application / Fastener / Tool Matrix

Application / Screw	Page	Suitable Systems/Attachments													
		PRO200	PRO200S	PRO250DW	PRO250	PRO300S	PROPP150	PROHX516	PROSD150	PROPH	PROHSD60	PROHSD75	BSD200	BGP300	PROHX14
Drywall															
DWC1PS	270	✓													
DWC114PS	270	✓													
DWC158PS	270	✓													
DWC2PS	270	✓		✓											
DWC212PS	270			✓											
DWF114PS	282	✓													
DWF158PS	282	✓													
DWFSD114PS	282	✓	✓*												
DWFSD158PS	282	✓	✓*												
DWFSD178PS	282	✓		✓											
DWFSD238PS	282			✓											
DWFSDQ114PS	282	✓	✓												
DWHL178PS	271	✓		✓											
Metal Roofing/Siding-to-Wood/Steel															
PC1BS1012	272						✓								
PC1BS1211	272						✓								
PCQ1BS1012	263						✓								
PCQ1BS1211	263						✓								
PCQ112BS1012	263						✓								
SSPC1BS1012	272						✓								
PCSD1S1016	280						✓								
PCSD1S1214	280						✓								
PCSDQ1S1016	280						✓								
PCSDQ1S1214	280						✓								
SSPCSD1S1016	280						✓								
HJ112WT10	261												✓		
HG112WS	261													✓	
HG112WT10	261												✓		
Steel-to-Steel															
FPHSD34S1016	275								✓	✓					
FPHSD34S1214	275								✓	✓					
PBSD34S0818	275								✓	✓					
X1S1016	278					✓	✓	✓							
XQ1S1016	278					✓	✓	✓							
X1S1214	278					✓	✓	✓							
XMQ114S1224	277							✓							
XLQ114T1224	277											✓			
XQ1S1214	278					✓	✓	✓							
XQ114S1224	278							✓							
XQ112S1224	278							✓							
PPSD11516S0818	276		✓		✓	✓									
PPSD134S1016	276		✓		✓	✓									
PPSD3S1016	276					✓									
PPSD3S1214	276											✓			
PPSD134S1214	276											✓			
Wood-to-Steel															
FHSD1S1018	283	✓	✓												
FHSD114S0818	283	✓	✓												
TB1445S	274									✓					
TB1460S	274									✓	✓				
TB1475S	274									✓	✓				
TBG1245S	274									✓	✓				
TBG1260S	274									✓	✓				
TBG1445S	274									✓	✓				
TBG1460S	274									✓	✓				
TBG1475S	274									✓	✓				
TBP1245S	274									✓	✓				
TBP1260S	274									✓	✓				
TBP1460S	274									✓	✓				
TBP1475S	274									✓	✓				
WSF134LRVS	283		✓		✓	✓						✓			
Composite Decking-to-Steel															
DCSD238SBR01	266				✓	✓									
DCSD238SRD01	266				✓	✓									
DCSD238STN01	266				✓	✓									
DCSD238STN02	266				✓	✓									
DCSD238SGR01	266				✓	✓									
DCSD238SGR04	266				✓	✓									

C-F-2017 © 2017 SIMPSON STRONG-TIE COMPANY INC.

Collated Screws for the Quik Drive® System

* Drive with PRO200S only when fastening fiberglass-mat gypsum sheathing panels.

Collated Exterior Wood Screws



Deck-Drive™ DSV WOOD Screw

Preservative-Treated Decking and Exterior Wood-to-Wood Applications

The Deck-Drive™ DSV Wood screw is a powerful fastening solution for preservative-treated decking applications. With its under-head ribs and fast-start tip, the DSV is ideally suited to be driven and countersunk into today's wood deck boards. The shank is designed to withstand the swelling and shrinkage that is common with fast-growth lumber. Available in hand-drive and in collated strips for use in our Quik Drive® auto-feed screw driving system, DSV screws are also offered in a variety of sizes to fasten fascia and trim.

Features:

- Low-torque threads
- Ribbed-head design countersinks easily and provides a clean, finished appearance
- High-low tip provides fast starts
- Optimized threads for dimensional lumber
- Quik Guard® coating provides corrosion resistance for exterior and certain preservative-treated wood applications
- Meets the performance requirements of AC257 exposure conditions 1 and 3
- Colors to blend in with most woods
- This screw is also available in bulk for hand-drive installation; see p. 78 for details

Quik Guard® Coating — Tan

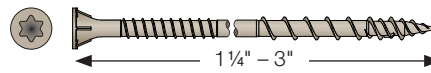

Size	Length (in.)	500 ct. Model No.	750 ct. Model No.	1,000 ct. Model No.	1,500 ct. Model No.	2,000 ct. Model No.	PRO 300S	PRO 250	PRO 200S
# 8	1 1/4	—	HCKDSVT114S	—	—	DSVT114S			✓
# 8	1 5/8	—	HCKDSVT158S	—	—	DSVT158S		✓	✓
#10	2	—	HCKDSVT2S	—	DSVT2S	—	✓	✓	✓
#10	2 1/2	HCKDSVT212S	—	DSVT212S	—	—	✓	✓	
#10	3	HCKDSVT3S	—	DSVT3S	—	—	✓		



Quik Guard® Coating — Red

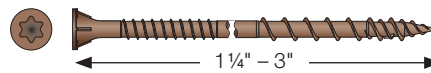

Size	Length (in.)	500 ct. Model No.	750 ct. Model No.	1,000 ct. Model No.	1,500 ct. Model No.	2,000 ct. Model No.	PRO 300S	PRO 250	PRO 200S
#8	1 1/4		HCKDSVR114S			DSVR114S			✓
#8	1 5/8		HCKDSVR158S			DSVR158S		✓	✓
#10	2		HCKDSVR2S		DSVR2S		✓	✓	✓
#10	2 1/2	HCKDSVR212S		DSVR212S			✓	✓	
#10	3	HCKDSVR3S		DSVR3S			✓		



Quik Guard® Coating — Gray

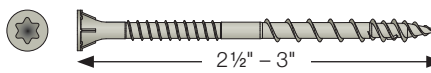

Size	Length (in.)	500 ct. Model No.	750 ct. Model No.	1,000 ct. Model No.	1,500 ct. Model No.	2,000 ct. Model No.	PRO 300S	PRO 250	PRO 200S
#10	2 1/2			DSVG212S			✓	✓	
#10	3			DSVG3S			✓		





Collated Exterior Wood Screws

Deck-Drive™ DWP WOOD SS Screw

Decking, Docks and Boardwalks; Finishing, Millwork and Trim

The Deck-Drive™ DWP Wood SS screw is a powerful fastening solution for deck, dock and general exterior applications where extra corrosion protection is needed. With its specially-designed sharp-point and unique box-threads, the DWP is ideally suited for the majority of wood used in today's wood deck boards. Choose Type 316 stainless steel for seaside and coastal environments. Available in hand-drive and in collated strips for use in our Quik Drive® auto-feed screw driving system.

Features:

- Unique "box" thread design with raised-ridge technology greatly reduces driving torque
- Specially-designed sharp point penetrates hard wood products with ease
- 6-lobe drive helps prevent driver-bit cam-out while driving easier and extending bit life (replacement bit BITTX25; see p. 248 for more information)
- Choose Type 316 stainless steel for seaside applications and superior corrosion resistance
- This screw is also available in bulk for hand-drive installation; see pp. 79-81 for details

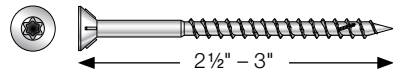

Type 316 Stainless Steel

Size	Length (in.)	1,000 ct. Model No.	1,500 ct. Model No.	PRO300S
#10	2½	—	SSDWP212S316	✓
#10	3	SSDWP3S316	—	✓

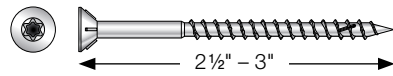

Type 305 Stainless Steel

Size	Length (in.)	1,000 ct. Model No.	1,500 ct. Model No.	PRO300S
#10	2½	SSDWP212S305	—	✓
#10	3	—	SSDWP3S305	✓

Deck-Drive™ DHPD HARDWOOD Screw

Hardwood Decking, Docks and Boardwalks

The Deck-Drive™ DHPD Hardwood screw is specially designed to penetrate the hardest wood products with ease. With its unique paddle-style drill point, it virtually eliminates splitting without predrilling. The wings on the shaft counterbore hard material, allowing the head to countersink easily for a clean, finished look. Available in Type 305 stainless steel for additional corrosion protection.

Features:

- Penetrate the hardest wood products without predrilling
- Compact head ensures a low-profile installation and reduced visibility
- Wings on the shaft counter-bore hard material and allow the head to countersink for a clean look
- Driver bit included in each package
- #2 square drive (replacement bit model BIT2S; see p. 248 for more information)
- This screw is also available in bulk for hand-drive installation; see p. 82 for details

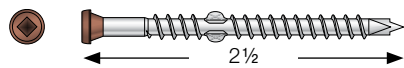

Type 305 Stainless Steel

Length (in.)	Shank Size	Threads Per Inch	Color	Retail Pack		Contractor Pack		PRO 300S	PRO 250
				Fasteners Per Pack	Model No.	Fasteners Per Pack	Model No.		
2½	#10	10	Unpainted	500	—	1,000	SSDHPD212S	✓	✓
2½	#10	10	Tan 03	—	—	1,000	SSDHPD212SB	✓	✓



Collated Exterior Wood Screws



Trim-Head Screw — Sharp Point

Features:

- Trim head
- #2 square drive (driver bit in each box; replacement bit model BIT2S)
- Box threads
- Curved collation
- Painted heads available in colors to match Azek® decking as well as a variety of decking colors from other manufacturers

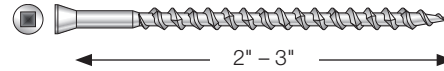

Type 305 Stainless Steel

Length (in.)	Shank Size	Head Color	Contractor Pack		PRO 250	PRO 300S
			Fasteners Per Pack	Model No.		
2	#7	Unpainted	2,000	SSDTH2S	✓	✓
2½	#7	Unpainted	1,000	SSDTH212S	✓	✓
3	#7	Unpainted	1,000	SSDTH3S		✓
2½	#7	Brown 01	1,000	DTH212S305BR01	✓	✓
2½	#7	Brown 05	1,000	DTH212S305BR05	✓	✓
2½	#7	Gray	1,000	DTH212S305GR	✓	✓
2½	#7	Gray 01	1,000	DTH212S305GR01	✓	✓
2½	#7	Gray 03	1,000	DTH212S305GR03	✓	✓
2½	#7	Gray 04	1,000	DTH212S305GR04	✓	✓
2½	#7	Tan	1,000	DTH212S305TN	✓	✓
2½	#7	Tan 01	1,000	DTH212S305TN01	✓	✓
2½	#7	Tan 02	1,000	DTH212S305TN02	✓	✓
2½	#7	Tan 03	1,000	DTH212S305TN03	✓	✓
2½	#7	Tan 04	1,000	DTH212S305TN04	✓	✓
2½	#7	Red 01	1,000	DTH212S305RD01	✓	✓





Collated Exterior Wood Screws

Trim-Head Screw — Type-17 Point

Features:

- Trim head with nibs for easy countersinking
- #2 undersized square drive (driver bit in each box; replacement bit model BIT2SU)
- Coarse threads
- Curved collation

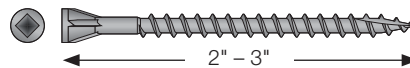

Quik Guard® Coating

Length (in.)	Shank Size	Retail Pack		Contractor Pack		PRO 200S	PRO 250	PRO 300S
		Fasteners Per Pack	Model No.	Fasteners Per Pack	Model No.			
2	#8	—	—	2,000	DTHQ2S	✓	✓	✓
2½	#8	750	HCKDTHQ212S	1,500	DTHQ212S		✓	✓
3	#8	500	HCKDTHQ3S	1,000	DTHQ3S			✓

Bugle-Head Wood Screw

Common Applications:

Wood decking to wood

Features:

- #3 square drive (driver bit in each box; replacement bit model BIT3S)
- Coarse threads
- Type-17 point
- Available in Types 316 and 305 stainless steel
- Curved collation

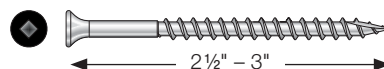

Type 316 Stainless Steel

Length (in.)	Shank Size	Carton Quantity	Model No.	PRO300S
2½	#10	1,500	SS3DSC212BS316	✓
3	#10	1,000	SS3DSC3BS316	✓

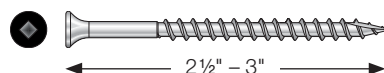

Type 305 Stainless Steel

Length (in.)	Shank Size	Carton Quantity	Model No.	PRO300S
2½	#10	1,500	SS3DSC212BS	✓
3	#10	1,000	SS3DSC3BS	✓



Collated Exterior Wood Screws

CB3BLG Fiber-Cement Board Screw

Common Applications:

Dense fiber-cement board to wood

Features:

- 0.375" ribbed wafer head with nibs for easy countersinking
- #3 undersized square drive (driver bit in each box; replacement bit model BIT3SU)
- Coarse threads
- Type-17 point
- C-3 mechanically galvanized coating
- Straight collation

Codes/Standards: ANSI A108 compliant

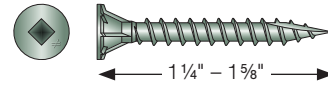

C-3 Mechanically Galvanized Coating

Length (in.)	Shank Size	Threads Per Inch	Contractor Pack		PROLDH
			Fasteners Per Pack	Model No.	
1 1/4	#10	10	1,500	CB3BLG114S	✓
1 5/8	#10	10	1,500	CB3BLG158S	✓

CB3BLGHL Cement Board Screw

Common Applications:

Cement board to wood (for coarse, porous and softer materials)

Features:

- 0.375" ribbed wafer head with nibs for easy countersinking
- #3 undersized square drive (driver bit in each box; replacement bit model BIT3SU)
- Alternating high-low threads
- Sharp point
- C-3 mechanically galvanized coating
- Straight collation

Codes/Standards: ANSI A108 compliant

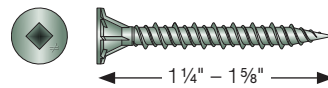

C-3 Mechanically Galvanized Coating

Length (in.)	Shank Size	Threads Per Inch	Contractor Pack		PROLDH
			Fasteners Per Pack	Model No.	
1 1/4	#9	15 High-Low	1,500	CB3BLGHL114S	✓
1 5/8	#9	15 High-Low	1,500	CB3BLGHL158S	✓



Collated Exterior Wood Screws

HJ Metal Roofing/Siding Panel Screw

Common Applications:

Metal roofing/siding panels to wood

Features:

- ¼" hex head
- EPDM-backed washer
- Sharp point
- Available in a variety of stock colors to match almost any roofing panel (see p. 262); custom colors available upon request
- Belt collation for BGP300

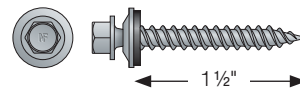

Exterior-Grade Coating

Length (in.)	Shank Size	Carton Quantity	Model No.	BGP300
1½	#10	500	HJ112WT10	✓

HG Metal Roofing/Siding Panel Screw

Common Applications:

Metal roofing/siding panels to wood

Features:

- ¼" hex head
- EPDM-backed washer
- Type-17 point for timber and light-steel battens
- Belt collated for the Quik Drive® BGP300 System
- Strip collated for the Quik Drive® HX14 System

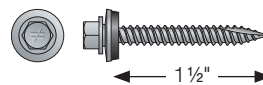

Exterior-Grade Coating

Length (in.)	Shank Size	Carton Quantity	Model No.	BGP300	HX14
1½	#10	500	HG112WT10	✓	
1½	#10	1,000	HG112WS		✓

Collated Exterior Wood Screws



Color Guide for HJ

Our collated hex-head fasteners are available in a variety of stock colors to match a wide variety of roofing panels. The color samples shown below are for reference only and shows the range of colors available.

Color	Belt Part Number
Bright White	HJ112WT10-0105
Medium Green	HJ112WT10-0402
Dark Green	HJ112WT10-0434
Red	HJ112WT10-0701
Bright Red	HJ112WT10-0703
Gray	HJ112WT10-1005
Dark Gray	HJ112WT10-1006
Brown	HJ112WT10-1103
Tan	HJ112WT10-1106
Saddle Tan	HJ112WT10-1107
Special Order	HJ112WT10-X
Galvanized	HG112WT10

These products are subject to quantities on hand or may require special ordering and are subject to minimum order quantities and longer lead times. Call Simpson Strong-Tie for details (800) 999-5099.

BRRED QC386 **0703**BROWN QC326 **1103**MDGREEN QC307 **0402**BRWHITE **0105**DARK GRAY **1006**RED QC259 **0701**SADDLE TAN **1107**TAN **1106**GRAY **1005**DKGREEN **0434**

In Canada, QC number codes reference the recognized color system of coil coater Baycoat Inc. in Hamilton, Ontario.

How to Order Fasteners for the BGP300G2

1. Select your fastener from p. 261, noting its model number in the table. Example: HJ112WT10
2. Select a color from the chart above, noting the color code under the right corner of the paint chip (in bold). Example: BRWHITE 0105
3. Add the color code to the end of the fastener model number to designate the color. Example model number with color code: HJ112WT10-0105



Collated Exterior Wood Screws

PC Standing-Seam-Roofing Panel Clip Screw

Common Applications:

Standing-seam-roofing panel clips to wood

Features:

- Pancake head
- #2 square drive (driver bit in each box; replacement bit model BIT2SU)
- Type-17 point
- Straight collation

Codes/Standards: ASTM C1513 compliant

Warning: Industry studies show that hardened fasteners can experience performance problems in wet or corrosive environments. Accordingly, use this product in dry, interior and noncorrosive environments only.



Quik Guard® Coating

Length (in.)	Shank Size	Threads Per Inch	Carton Quantity	Model No.	PROPP150
1	#10	12	1,500	PCQ1BS1012	✓
1½	#10	12	1,500	PCQ112BS1012	✓
1	#12	11	1,500	PCQ1BS1211	✓

WSC Wood Screw

Common Applications:

Wood to wood

Features:

- Flat head with nibs under the head for easier countersinking
- #2 square drive (replacement bit models BIT2SU)
- Coarse threads
- Curved collation

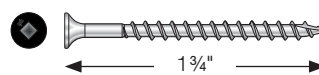

N2000® Coating

Length (in.)	Shank Size	Point Type	Carton Quantity	Model No.	PR0200S	PR0250	PR0300S
1¼	#8	Sharp Point	2,000	WSCG134S	✓	✓	✓

Collated Exterior Wood Screws



SIMPSON

Strong-Tie®

SSWSCB Roofing Tile Screw

Common Applications:

Roofing tiles to wood

Features:

- Bugle head
- #2 square drive (driver bit in each box; replacement bit model BIT2S)
- Coarse threads
- Type-17 point
- Curved collation

Codes/Standards: Meets the requirements of the Tile Roofing Institute as described in ESR-2015P. A Miami-Dade compliant roofing product (2" and 2 ½" only).

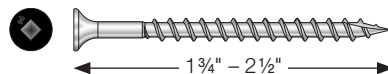

Type 305 Stainless Steel

Length (in.)	Shank Size	Carton Quantity	Model No.	PRORF	PRO300SRF
1 ¾	#8	2,000	SSWSC134BS	✓	✓
2	#8	2,000	SSWSC2BS	✓	✓
2 ½	#8	1,500	SSWSC212BS	✓	✓

WSCT Roofing Tile Screw

Common Applications:

Roofing tiles to wood

Features:

- Flat head
- #3 square drive (driver bit in each box; replacement bit model BIT3S)
- Twin threads
- Sharp point
- Curved collation

Codes/Standards: ASTM A641 (Class 1)

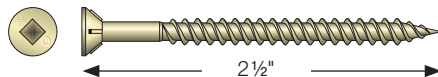

Heavy Zinc Electroplate

Length (in.)	Shank Size	Carton Quantity	Model No.	PRORF	PRO300SRF
2 ½	#8	1,500	WSCT212S	✓	✓

WSCD Roofing Tile Screw

Common Applications:

Roofing tiles to wood

Features:

- Flat head
- #3 square drive (driver bit in each box; replacement bit model BIT3SU)
- Twin threads
- Sharp point
- Curved collation

Codes/Standards: Meets the requirements of the Tile Roofing Institute as described in ESR-2015P. Miami-Dade Fastener Listing 10-0330.06

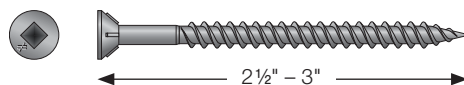

Mechanically Galvanized – Class 55

Length (in.)	Shank Size	Carton Quantity	Model No.	PRO RF	PRO 300SRF
2 ½	#8	1,500	WSCD212S	✓	✓
3	#8	1,000	WSCD3S		✓



Collated Composite Decking Screws

Deck-Drive™ DCU COMPOSITE Screw

Fastening Composite Decking Boards

The Deck-Drive™ DCU Composite screw is engineered to provide beautiful fastening results for all types of composite decking while also offering greater ease of installation, a clean finish and superb corrosion resistance. The Deck-Drive DCU is the go-to-screw for all your composite decking applications, eliminating the need to mix and match screws to the decking they are suited for.

Deck-Drive DCU Composite decking screws are available in carbon steel with our Quik Guard® coating. For superior corrosion resistance in marine or high-exposure environments, choose the appropriate stainless-steel DCU screw (Type 305 or Type 316). DCU screws provide a clean finish because of their special head design and are available in 11 colors, matched to blend with most major decking manufacturers.

Features:

- Available in carbon steel, as well as Type 305 and Type 316 stainless steel for high to severe levels of corrosion resistance
- Tri-lobe thread design reduces damage to the composite board while driving
- Inverted upper threads clear excess material to ensure the screw is seated properly and consistently
- Double-cut point penetrates composite decking with ease for faster starts
- Cap-head prevents mushrooming and material from rising up above the deck for a smoother, clean-looking installation
- Approved fastener (by Trex®) for Trex® composite decking
- Also available in bulk for hand-drive installation; see pp. 89–90 for details

Carbon Steel, Quik Guard® Coating

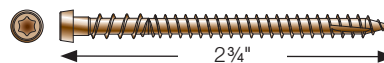

Size	Length (in.)	Color	Model No. (1,000 ct.)	PRO300S
#10	2 3/4	Brown 01	DCU234SBR01	✓
#10	2 3/4	Brown 05	DCU234SBR05	✓
#10	2 3/4	Gray	DCU234SGR	✓
#10	2 3/4	Gray 01	DCU234SGR01	✓
#10	2 3/4	Gray 04	DCU234SGR04	✓
#10	2 3/4	Red	DCU234SRD	✓
#10	2 3/4	Red 01	DCU234SRD01	✓
#10	2 3/4	Tan	DCU234STN	✓
#10	2 3/4	Tan 01	DCU234STN01	✓
#10	2 3/4	Tan 02	DCU234STN02	✓
#10	2 3/4	Tan 03	DCU234STN03	✓



Type 305 or 316 Stainless Steel

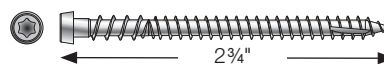

Size	Length (in.)	Material	Model No. (1,000 ct.)	PRO300S
#10	2 3/4	Type 305 stainless steel	DCU234S305	✓
#10	2 3/4	Type 316 stainless steel	DCU234S316	✓

Type 316 Stainless Steel, Painted Head

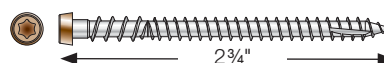

Size	Length (in.)	Color	Model No. (1,000 ct.)	PRO300S
#10	2 3/4	Brown 01	DCU234S316BR01	✓
#10	2 3/4	Brown 05	DCU234S316BR05	✓
#10	2 3/4	Gray	DCU234S316GR	✓
#10	2 3/4	Gray 01	DCU234S316GR01	✓
#10	2 3/4	Gray 04	DCU234S316GR04	✓
#10	2 3/4	Red	DCU234S316RD	✓
#10	2 3/4	Red 01	DCU234S316RD01	✓
#10	2 3/4	Tan	DCU234S316TN	✓
#10	2 3/4	Tan 01	DCU234S316TN01	✓
#10	2 3/4	Tan 02	DCU234S316TN02	✓
#10	2 3/4	Tan 03	DCU234S316TN03	✓



Collated Composite Decking Screws



Deck-Drive™ DCSD COMPOSITE-TO-STEEL Screw

Composite Decking to Steel Deck Framing

Features:

- Drives easily through double 14 ga. steel box beam without pre-drilling
- Provides a clean, finished deck surface with no mushrooming
- The Quik Drive® system holds the screw securely as it drills through the metal joist for a more consistent installation
- #2 square drive (replacement bit BIT2SU; see p. 248 for more information)

See pp. 24–25 for Color Reference Chart for Decking Manufacturers

Approved fastener (by Trex) for Trex® Elevations™

U.S. Patent 9,322,422

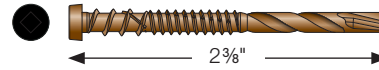

Quik Guard® Coating

Length (in.)	Size	Color	Quik Drive Part # (1,000 ct.)	Use with Trex® Color (Colors will also match other major composite decking manufacturers)	PRO 250	PRO 300S
2 3/8	#10	Brown 01	DCSD238SBR01	Vintage Lantern	✓	✓
2 3/8	#10	Tan 01	DCSD238STN01	Tree House, Saddle, Spiced Rum, Tiki Torch, Barrel	✓	✓
2 3/8	#10	Gray 01	DCSD238SGR01	Gravel Path	✓	✓
2 3/8	#10	Red 01	DCSD238SRD01	Lava Rock, Fire Pit	✓	✓
2 3/8	#10	Gray 04	DCSD238SGR04	Flint, Select Winchester Gray	✓	✓
2 3/8	#10	Tan 02	DCSD238STN02	Rope Swing	✓	✓

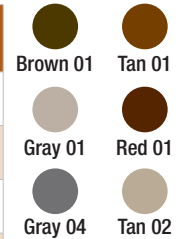



Collated Interior Wood Screws

Strong-Drive® WSV SUBFLOOR Screw

Subfloor and Sheathing Projects

Simpson Strong-Tie® has re-engineered its popular subfloor screw to reduce driving force and increase installation speed. The new Strong-Drive® WSV Subfloor screw has been developed for fastening subfloor sheathing using the Quik Drive® auto-feed screw driving system.

Features:

- Redesigned tip and thread pattern provides easy starts and up to 25% less torque while driving¹ – makes for up to 20% faster driving²
- Less installation torque also means less wear on tools
- Deep six-lobe recessed ribbed head provides clean countersinking and more secure bit retention for fewer cam-outs
- The holding power of WSV screws reduces the gaps between the joist and subfloor that cause floor squeaks
- WSV screws can be easily backed out allowing for future access to floor cavities
- 6-lobe T-25 drive bit (replacement bit BITX25)

1. Test data shows the Strong-Drive WSV Subfloor screw requires up to 25% less driving torque in single-material LVL.

2. Test data indicates this redesigned WSV thread pattern will result in 20% faster screw installations.

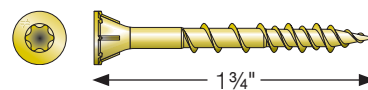

Yellow Zinc Coating

Length (in.)	Shank Size	Head Diameter (in.)	Point Type	Carton Quantity	Model No.	PRO 200S	PRO 250	PRO 300S
1 3/4	#9	0.333	Sharp	2,000	WSV134S	✓	✓	✓

Strong-Drive® WSNTL WOOD Screw

Interior Wood-to-Wood Applications

Common Applications:

Fire-rated sheathing and treated wood applications

Features:

- Flat head with nibs for easy countersinking
- #3 square drive (driver bit in each box; replacement bit model BIT3SU)
- Twin threads
- Sharp point
- Curved collation

Codes/Standards: ESR-1472

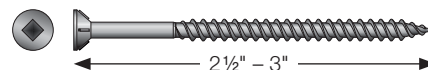

Quik Guard® Coating

Length (in.)	Shank Size	#3 Drive Type	Retail Pack		Contractor Pack		PRO 250	PRO 300S
			Fasteners Per Pack	Model No.	Fasteners Per Pack	Model No.		
2 1/2	#8	Undersized	—	—	1,500	WSNTLQ212S	✓	✓
3	#8	Undersized	—	—	1,000	WSNTLQ3S		✓



Mechanically Galvanized – Class 55

Length (in.)	Shank Size	#3 Drive Type	Retail Pack		Contractor Pack		PRO 200S	PRO 250	PRO 300S
			Fasteners Per Pack	Model No.	Fasteners Per Pack	Model No.			
2	#8	Undersized	1,000	HCKWSNTLG2S	2,000	WSNTLG2S	✓	✓	✓
2 1/2	#8	Undersized	750	HCKWSNTG212S	1,500	WSNTLG212S		✓	✓
3	#8	Undersized	500	HCKWSNTLG3S	1,000	WSNTLG3S			✓



Collated Interior Wood Screws

Strong-Drive® WSNTL SUBFLOOR Screw

For Subfloor and Sheathing to Wood, Multi-Ply Wood Members
Code-Listed, Collated Screws Exceed Values of 10d Nails

Strong-Drive® WSNTL Subfloor screws are ideal for fastening subfloor, sheathing, sill plate and stair tread applications using the Simpson Strong-Tie® Quik Drive® auto-feed screw driving system. With lateral shear, withdrawal and pull-through values that exceed those of 10d common nails, the holding power of WSNTL screws reduces gaps between the joist and subfloor that cause floor squeaks. Installing WSNTL screws removes the need for gluing in diaphragm applications, eliminating the precise timing, labor and materials that the process requires. Using screws that can be backed out easily allows future access to floor cavities.

Common Applications:

Subfloor and sheathing to wood and EWP-Ply fastening for multi-ply trusses

Features:

- Eliminates subfloor nail squeaking and costly call-backs
- Variety of lengths to cover subfloor, wall plates and stair treads
- #3 square drive (driver bit in each box; replacement bit model BIT3S)
- Minimum fastener penetration of 1¼" into framing member is required
- Also available in bulk for hand-drive installation; see p. 96 for details

Codes/Standards: ICC-ES ESR-1472; City of L.A. RR25661 (Note: 1¾" length not code listed)

For Technical Data and Loads, see pp. 366–369

For information on corrosion, materials and coatings, see pp. 17–21

Yellow Zinc Coating

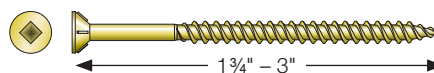

Length (in.)	Shank Size	Retail Pack		Contractor Pack		PRO 200S	PRO 250	PRO 300S
		Fasteners Per Pack	Model No.	Fasteners Per Pack	Model No.			
1¾	#8	1,000	HCKWSNTL134S	2,000	WSNTL134S	✓	✓	✓
2	#8	1,000	HCKWSNTL2LS	2,000	WSNTL2LS	✓	✓	✓
2½	#8	750	HCKWSNTL212S	1,500	WSNTL212S		✓	✓
3	#8	500	HCKWSNTL3S	1,000	WSNTL3S			✓

Holding Power of Typical Sheathing Fasteners as Compared to WSNTL2LS

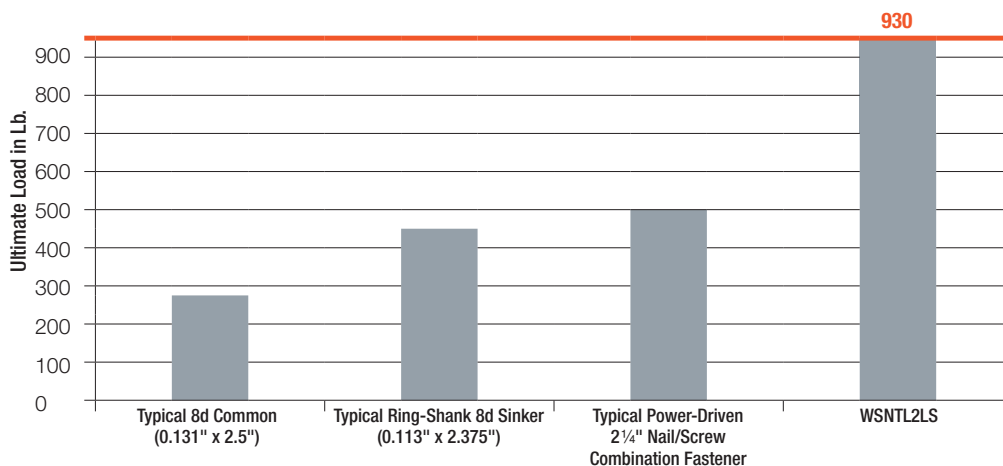

1. Chart based on resultant penetration of the attachment of 1½" thick sheathing with a Douglas Fir main member.
2. 8d common ultimate loads are based on National Design Specification (NDS) design and multiplied by a factor of safety of five.
3. 8d sinker ring, nail/screw combination and WSNTL fasteners withdrawal load based on withdrawal testing in accordance with ICC-ES AC 233, ICC-ES AC116 and ASTM D1761.



Collated Interior Wood Screws

“Hear” the Difference over Time

Squeaking of newly installed floors can result in expensive (travel, labor, materials) callbacks and possibly a damaged reputation. Fastening subflooring with WSNTL Subfloor screws rather than pneumatic fasteners provides the power necessary to pull together joists and plywood (or WSP sheathing), eliminating any gaps, holding the materials firm and therefore reducing squeaks.

Plywood or WSP sheathing

Gap

Joist

Subfloor Fastened with Power-Driven Fasteners
Fastening with power-driven fasteners can leave gaps or allow gaps to develop over time. These gaps cause the subfloor to ride up and down on the pneumatic fastener's shank, which leads to squeaks.

VS.

Plywood or WSP sheathing

No gap

Joist

Subfloor Fastened with WSNTL Subfloor Screw
Subfloor fastened with screws is pulled down and kept tight against the joist, with no gaps to cause squeaking.

“See” the Difference on the Jobsite

The WSNTL Subfloor screw gives visual confirmation of a secure joist connection by countersinking, while “shot-in” power-driven fasteners look the same whether or not they hit the joist. Missed fasteners could result in floor flexing that can cause squeaking in other parts of the structure and reduced diaphragm load capacity.

No indication of missed joist

Plywood or WSP sheathing

Joist

Subfloor Fastened with Power-Driven Fasteners

VS.

Visual confirmation of missed joist

Plywood or WSP sheathing

Joist

Subfloor Fastened with WSNTL Subfloor Screw



Collated Interior Wood Screws

WSHL Subfloor Screw

Common Applications:

Subfloor to wood

Features:

- Ribbed flat head with nibs for easy countersinking
- #2 square drive (driver bit in each box; replacement bit model BIT2S)
- High-low threads
- Sharp point
- Gray phosphate coating
- Curved collation
- 1:1 replacement for 8d common nails when used with floor sheathing 1⁵/₃₂–2³/₃₂" thick



Gray Phosphate Coating

Length (in.)	Shank Size	Carton Quantity	Model No.	PRO 200S	PRO 250	PRO 300S
1 3/4	#7	2,000	WSHL134S7	✓	✓	✓

DWC Drywall Screw

Common Applications:

Drywall to wood

Features:

- Bugle head
- #2 Phillips (driver bit in each box; replacement bit model BIT2P)
- Coarse threads
- Sharp point
- Curved collation

Codes/Standards: ASTM C1002 Type W



Gray Phosphate Coating

Length (in.)	Shank Size	Retail Pack		Contractor Pack		PRO 200	PRO 250DW
		Fasteners Per Pack	Model No.	Fasteners Per Pack	Model No.		
1	#6	—	—	2,500	DWC1PS	✓	
1 1/4	#6	1,000	HCKDWC114PS	2,500	DWC114PS	✓	
1 5/8	#6	1,000	HCKDWC158PS	2,500	DWC158PS	✓	
2	#6	—	—	2,000	DWC2PS	✓	✓
2 1/2	#8	—	—	1,500	DWC212PS		✓



Collated Interior Wood Screws

DWHL Drywall Screw

Common Applications:

Drywall to wood

Features:

- Bugle head
- #2 Phillips drive (driver bit in each box; replacement bit model BIT2P)
- High-low threads
- Sharp point
- Gray phosphate coating
- Curved collation

Codes/Standards: ASTM C1002 Type W

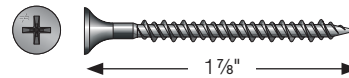

Gray Phosphate Coating

Length (in.)	Shank Size	Carton Quantity	Model No.	PRO 250DW	PRO 200
1 7/8	#6	2,000	DWHL178PS	✓	✓

MTH Wood Underlayment Screw

Common Applications:

Wood underlayment to wood

Features:

- Trim head with nibs for easy countersinking
- #2 square drive (driver bit in each box; replacement bit model BIT2S)
- High-low threads
- Sharp point
- Curved collation

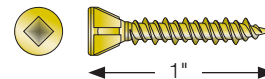

Yellow Zinc Coating

Length (in.)	Shank Size	Coating	Retail Pack		Contractor Pack		PRO200S
			Fasteners Per Pack	Model No.	Fasteners Per Pack	Model No.	
1	#7	Yellow Zinc	—	—	2,500	MTHZ1S	✓

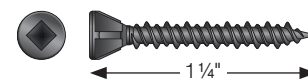

Gray Phosphate Coating

Length (in.)	Shank Size	Coating	Retail Pack		Contractor Pack		PRO200S
			Fasteners Per Pack	Model No.	Fasteners Per Pack	Model No.	
1 1/4	#7	Gray Phosphate	1,000	HCKMTH114S	2,500	MTH114S	✓

Collated Interior Wood Screws



PC Standing-Seam-Roofing Panel Clip Screw

Common Applications:

Standing-seam-roofing panel clips to wood

Features:

- Pancake head
- #2 square drive (driver bit in each box; replacement bit model BIT2S)
- Type-17 point
- Straight collation
- Type 410 stainless steel is coated for additional corrosion protection

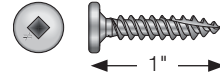

Type 410 Stainless Steel*

Length (in.)	Shank Size	#2 Drive Type	Threads Per Inch	Carton Quantity	Model No.	PROPP150
1	#10	Standard	12	1,500	SSPC1BS1012	✓

* These products are subject to quantities on hand or may require special ordering and are subject to minimum order quantities and longer lead times. Call Simpson Strong-Tie for details (800) 999-5099.

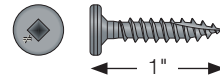

Clear Zinc Coating

Length (in.)	Shank Size	#2 Drive Type	Threads Per Inch	Carton Quantity	Model No.	PROPP150
1	#10	Standard	12	1,500	PC1BS1012	✓
1	#12	Standard	11	1,500	PC1BS1211	✓



Collated Interior Wood Screws

PHSS Wood Screw

Common Applications:

Wood to wood

Features:

- Pan head
- #2 square drive (driver bit in each box; replacement bit model BIT2S)
- Twin threads
- Sharp point
- Yellow zinc coating
- Curved collation

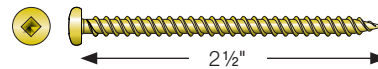

Yellow Zinc Coating

Length (in.)	Shank Size	Carton Quantity	Model No.	PRO 250	PRO 300S
2 1/2	#8	1,500	PHSS212S	✓	✓

WSC Wood Screw

Common Applications:

Wood to wood

Features:

- Flat head with nibs for easy countersinking
- #2 square drive (driver bit in each box; replacement bit model BIT2S)
- Coarse threads
- Available with Type-17 and sharp points
- Curved collation

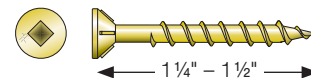

Yellow Zinc Coating

Length (in.)	Shank Size	Point Type	Carton Quantity	Model No.	PRO200S	PRO250
1 1/4	#8	Type-17	2,500	WSC114S-17	✓	
1 1/2*	#8	Sharp	2,000	WSC112S	✓	✓

* This size does not have nibs under the head.

WSCLT Wood Screw

Common Applications:

Wood to wood

Features:

- Flat head
- #2 square drive (driver bit in each box; replacement bit model BIT2S)
- Coarse threads
- Sharp point
- Yellow zinc coating
- Curved collation
- Fully threaded

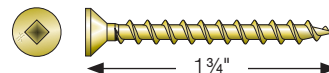

Yellow Zinc Coating

Length (in.)	Shank Size	Carton Quantity	Model No.	PRO 200S	PRO 250	PRO 300S
1 3/4	#8	2,000	WSCLT134S	✓	✓	✓



Collated Metal Screws

Strong-Drive® TB WOOD-TO-STEEL Screw

Common Applications:

Wood to hot-rolled steel (Maximum recommended thicknesses: 5/16")

Features:

- Flat head with nibs for easy countersinking
- #4 drill point with wings
- #3 square drive (driver bit in each box; replacement bit model BIT3S; use BIT3SU for Mechanically Galvanized – N2000®)
- Straight collation
- This screw is also available in bulk for hand-drive installation; see p. 100 for details

For Technical Data and Loads, see p. 365

Warning: Industry studies show that hardened fasteners can experience performance problems in wet or corrosive environments. Accordingly, use this product in dry, interior and noncorrosive environments only.

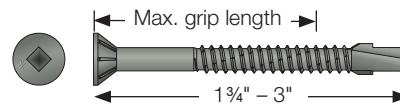

Mechanically Galvanized – N2000®

Length in. (mm)	Max. Grip Length (in.)*	Shank Size	Threads Per Inch	Carton Quantity	Model No.	PRO HSD60	PRO HSD75
1 3/4 (45)	1.055	#12	14	1,000	TBG1245S	✓	
2 3/8 (60)	1.645	#12	14	1,000	TBG1260S	✓	✓
1 3/4 (45)	1.055	#14	14	1,000	TBG1445S	✓	
2 3/8 (60)	1.645	#14	14	750	TBG1460S	✓	✓
3 (75)	2.236	#14	14	750	TBG1475S		✓

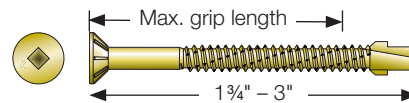

Yellow Zinc Coating

Length in. (mm)	Max. Grip Length (in.)*	Shank Size	Threads Per Inch	Carton Quantity	Model No.	PRO HSD60	PRO HSD75
1 1/2 (40)	0.826	#14	14	1,000	TB1440S	✓	
1 3/4 (45)	1.055	#14	14	1,000	TB1445S	✓	
2 3/8 (60)	1.645	#14	14	750	TB1460S	✓	✓
3 (75)	2.236	#14	14	750	TB1475S		✓



Black Phosphate Coating

Length in. (mm)	Max. Grip Length (in.)*	Shank Size	Threads Per Inch	Carton Quantity	Model No.	PRO HSD60	PRO HSD75
1 3/4 (45)	1.055	#12	14	1,000	TBP1245S	✓	
2 3/8 (60)	1.645	#12	14	1,000	TBP1260S	✓	✓
2 3/8 (60)	1.645	#14	14	750	TBP1460S	✓	✓
3 (75)	2.236	#14	14	750	TBP1475S		✓

* Grip length includes side member, steel thickness, air gaps (if any) and allowance for three threads protruding through the steel.



Collated Metal Screws

Strong-Drive® PHSD FRAMING-TO-CFS Screw

Common Applications:

Cold-formed steel framing and sheet steel sheathing to cold-formed steel

Features:

- Pan head
- #2 drill point
- #2 square drive (driver bit in each box; replacement bit model BIT2S)
- Yellow zinc coating
- Straight collation

Codes/Standards: ASTM C1513 compliant, City of LA RR25670

For Technical Data and Loads, see p. 372

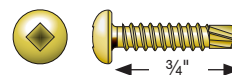

Yellow Zinc Coating

Length (in.)	Shank Size	Threads Per Inch	Point Size	Carton Quantity	Model No.	PROPH
3/4	#8	18	2	2,500	PHSD34S0818	✓

Strong-Drive® FPHSD FRAMING-TO-CFS Screw

Common Applications:

Cold-formed steel framing and sheet steel sheathing to cold form steel

Features:

- Flat pan head
- Clear zinc coating
- #3 square drive (driver bit in each box; replacement bit model BIT3S)
- Straight collation
- #3 drill point
- This screw is also available in bulk for hand-drive installation; see p. 102 for details

Codes/Standards: ASTM C1513 compliant

For Technical Data and Loads, see p. 373

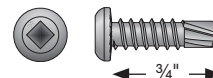

Clear Zinc Coating

Length (in.)	Shank Size	Threads Per Inch	Point Size	Carton Quantity	Model No.	PROSD150	PROPH
3/4	#10	16	3	2,500	FPHSD34S1016	✓	✓
3/4	#12	14	3	2,500	FPHSD34S1214	✓	✓



Collated Metal Screws

Strong-Drive® PPSD SHEATHING-TO-CFS Screw

Common Applications:

Subfloor/sheathing to cold-formed steel, (#8 – maximum thickness: 54 mil/16 ga., #10, #12 – maximum thickness: 97 mil/12 ga.)

Features:

- Flat head
- #3 square drive (driver bit in each box; use replacement bit model BIT3SU for Quik Guard® and BIT3S for yellow zinc coating)
- Fine threads
- Pilot point
- Quik Guard® and yellow zinc coating
- Curved collation
- #8 and #10 screws meet minimum head diameter requirement per AISI S213-07, lateral design standard
- Also available in bulk for hand-drive installation; see p. 101 for details

Codes/Standards: ASTM C1513 compliant

For Technical Data and Loads, see p. 371

Warning: Industry studies show that hardened fasteners can experience performance problems in wet or corrosive environments. Accordingly, use this product in dry, interior and noncorrosive environments only.

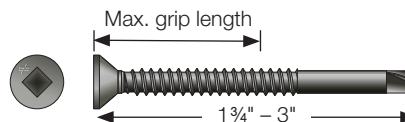

Quik Guard® Coating

Length (in.)	Shank Size	Min. Head Diameter (in.)	Point Size	Thread Length (in.)	Max. Grip Length (in.)	Threads per Inch	Carton Quantity	Model No.	PRO 200S	PRO 250	PRO 300S	HSD60	HSD75
1 15/16	#8	0.315	2	1.220	1.03	18	2,000	PPSDQ11516S0818	✓	✓	✓		
1 3/4	#10	0.325	3	0.989	0.773	16	2,000	PPSDQ134S1016	✓	✓	✓		
1 3/4	#12	0.452	3	0.984	0.773	14	1,000	PPSDQ134S1214*				✓	✓
3	#10	0.325	3	1.464	1.246	16	1,000	PPSDQ3S1016			✓		
3	#12	0.452	3	1.469	1.246	14	1,000	PPSDQ3S1214*					✓

*Has underhead nibs.

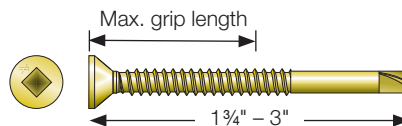

Yellow Zinc Coating

Length (in.)	Shank Size	Min. Head Diameter (in.)	Point Size	Thread Length (in.)	Max. Grip Length (in.)	Threads per Inch	Carton Quantity	Model No.	PRO 200S	PRO 250	PRO 300S	HSD60	HSD75
1 15/16	#8	0.315	2	1.220	1.03	18	2,000	PPSD11516S0818	✓	✓	✓		
1 3/4	#10	0.325	3	0.989	0.773	16	2,000	PPSD134S1016	✓	✓	✓		
1 3/4	#12	0.452	3	0.984	0.773	14	1,000	PPSD134S1214*				✓	✓
3	#10	0.325	3	1.464	1.246	16	1,000	PPSD3S1016			✓		
3	#12	0.452	3	1.469	1.246	14	1,000	PPSD3S1214*					✓

*Has underhead nibs.



Collated Metal Screws

Strong-Drive® XL LARGE-HEAD METAL Screw

Steel decking or other cold-formed steel framing; connectors to structural steel

Strong-Drive® XL Large-Head Metal screws are load-tested and code-listed, allowing you to get the maximum load values for installation. These screws are the perfect choice when high shear or uplift resistance is required and can be excellent 1-for-1 replacements for pins.

Features:

- 5/16" hex drive (driver part #BITHEXLB516)
- #5 drill point
- Quik Guard® coating
- 5/8" diameter hex washer head
- Also available in bulk for hand-drive installation; see p. 97 for details

Codes/Standards: IAPMO UES ER-326, FM Approval 3050714, State of Florida FL16937, City of Los Angeles RR26009, SDI DDM03 Appendix IX, SDI DDM04

For Technical Data and Loads, see p. 381

U.S. Patent Pending

Warning: Industry studies show that hardened fasteners can experience performance problems in wet or corrosive environments. Accordingly, use this product in dry, interior and noncorrosive environments only.

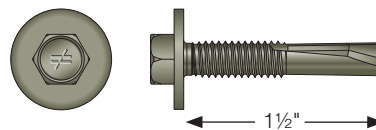

Quik Guard® Coating

Size	Length (in.)	Hex Head Size (in.)	Washer Dia. (in.)	Threads Per Inch	Point Size	Suitable Material Thickness (in.)	Carton Qty.	Model No.	BSD200
#12	1 1/4	5/16	0.625	24	#5	0.125–0.500	1,000	XLQ114T1224	✓

Strong-Drive® XM MEDIUM-HEAD METAL Screw

Steel decking to structural members involving wide or narrow valley; nestable or interlocking steel decking

Strong-Drive® metal screws are load-tested and code-listed, allowing you to get the maximum load values for installation. Comparison testing shows Strong-Drive® XM Medium-Head Metal screws are stronger than many alternative fastener types in 33 ksi and 50 ksi steel decking.

Features:

- 5/16" hex drive
- 1/2"-dia. hex washer head is ideal for narrow-channel steel decking
- Available only in 1 1/4" length with #5 drill point
- Available in Quik Guard® coating
- Also available in bulk for hand-drive installation; see p. 97 for details

Codes/Standards: IAPMO UES ER-326, FM Approval 3050714, State of Florida FL16937, City of Los Angeles RR26009, SDI DDM04

For Technical Data and Loads, see p. 381

U.S. Patent Pending

Warning: Industry studies show that hardened fasteners can experience performance problems in wet or corrosive environments. Accordingly, use this product in dry, interior and noncorrosive environments only.

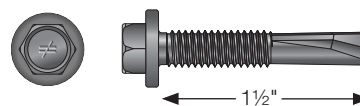

Quik Guard® Coating

Size	Length (in.)	Hex Head Size (in.)	Washer Dia. (in.)	Threads Per Inch	Point Size	Suitable Material Thickness (in.)	Carton Qty.	Model No.	PROSDX150
#12	1 1/4	5/16	0.483	24	#5	0.125–0.500	1,500	XMQ114S1224	✓



Collated Metal Screws

Strong-Drive® SELF-DRILLING X METAL Screw

Common Applications:

1. Steel decking to structural steel; 2. Steel stitching ("side-lap" stitching); 3. Cold-formed steel framing

Features:

- 5/16" hex head
- Drill point
- Hex washer head
- Straight collation
- This screw is also available in bulk for hand-drive installation; see p. 98 for details

Codes/Standards: ICC-ES ESR-3006, City of LA RR25670 and RR25917, ASTM C1513 compliant, FM Approval #3045651, SDI DDM03, Appendix VII, IAPMO-UES ER-326, SDI DDM04, State of Florida FL16937

For Technical Data and Loads, see p. 380

Warning: Industry studies show that hardened fasteners can experience performance problems in wet or corrosive environments. Accordingly, use this product in dry, interior and noncorrosive environments only.

Quik Guard® Coating

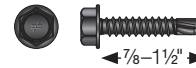

Length (in.)	Shank Size	Threads Per Inch	Point Size	Carton Quantity	Model No.	PRO HX516	PRO SDX150	PRO SD150	Application(s)
1	#10	16	3	1,500	XQ1S1016	✓	✓	✓	2, 3
1	#12	14	3	1,500	XQ1S1214	✓	✓	✓	2, 3
1¼	#12	24	5	1,500	XQ114S1224		✓	✓	1, 3
1½	#12	24	5	1,500	XQ112S1224		✓	✓	1, 3

Clear Zinc Coating

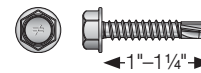

Length (in.)	Shank Size	Threads Per Inch	Point Size	Carton Quantity	Model No.	PRO HX516	PRO SDX150	PRO SD150	Application(s)
¾	#10	16	1	1,500	XU34S1016		✓	✓	2, 3
1	#10	16	3	1,500	X1S1016	✓	✓	✓	2, 3
1	#12	14	3	1,500	X1S1214	✓	✓	✓	2, 3



Collated Metal Screws

Steel Deck Diaphragm Calculator

The Steel Deck Diaphragm Calculator web app offers optimized steel deck design solutions based on fastener and labor costs for a given shear and uplift. It can provide calculations for any solution generated. Generate diaphragm tables for various roof and floor decks using Simpson Strong-Tie® fasteners. The app can also generate a submittal package that includes fastener information, code reports, Factory Mutual reports, Appendix VII and IX of DDM03 (also reference DDM04), coating information and tools for installation. The app is accessible from any web browser and does not require downloading or installing special software. Users can:

- Design for multiple zones and develop solutions in either ASD or LRFD
- Modify deck properties from the standard properties listed in SDI DDM03 and DDM04
- Generate multiple cost- and labor-optimized solutions with calculations included
- Generate tables in Nominal, ASD Wind, LRFD Wind, ASD Seismic or LRFD Seismic
- Design for loads using the new Strong-Drive® XL Large-Head Metal screw (included in the optimization calculator)
- Design for additional structural patterns not covered in SDI literature
- Access proprietary deck tables with the new Strong-Drive® XM Medium-Head Metal screw

Steel Deck Diaphragm Load Tables for Interlocking Decks

Load tables are available on our website application for using Strong-Drive XM Medium-Head Metal screws on frequently used interlocking decks with proprietary side-lap connections.

For more information regarding Strong-Drive XM Medium-Head Metal screw shear tables, refer to strongtie.com/diaphragmcalc.

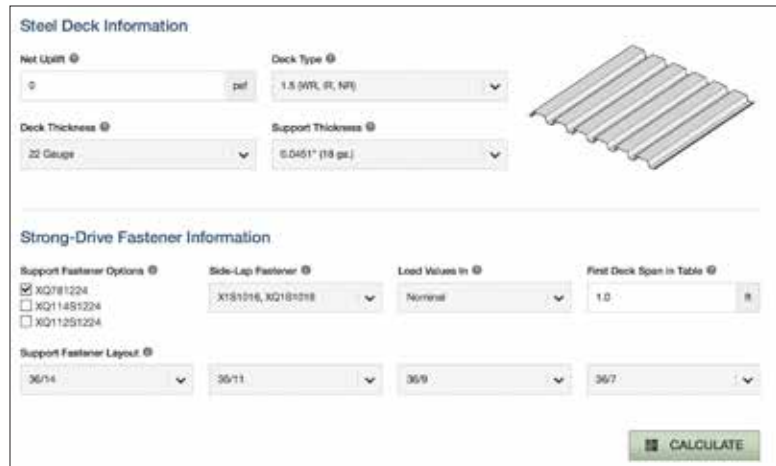
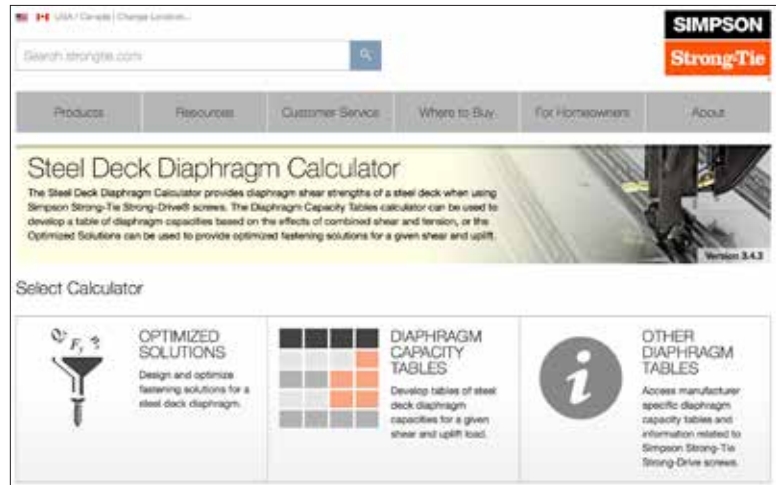

Example of Steel Deck Diaphragm Calculator Web Application

Example of Steel Deck Diaphragm Load Table for Interlocking Decks

Diaphragm Shear Strength Tables: 0.0451" (18 ga.) Support Steel Thickness
1.5 (WR, IR, NR) x 22 Gauge (t = design thickness = 0.0295)

Support Fasteners: XQ21224, XQ11451224, XQ11251224
Side-Lap Fasteners: X1S1016, XQ1S1018

φ (EQ): 0.85 φ (EQ): 2.50
φ (Wind): 0.70 φ (Wind): 2.35
φ (Other): 0.85 φ (Other): 2.50

Click on a shear strength or KI value in the table below to view and print specific calculations.

Support Fastener Layout	Side Lap Fasteners Per Span	Nominal Shear Strength (qf)										KI	
		1.0	1.5	2.0	2.5	3.0	3.5	4.0	4.5	5.0	5.5		6.0
36/14	0	2026	2311	1871	1567	1229	1150	1024	881	794			0.274
	1	3103	2818	3068	2737	1890	1301	1332	1018	912	824	732	0.236
	2	3249	2893	2248	1809	1645	1441	1280	1150	1020	932	850	0.207
	3	3382	2842	2412	2000	1791	1629	1404	1264	1148	1030	948	0.190
	4	3497	2880	2356	2008	1878	1720	1524	1379	1251	1136	1041	0.188
	5	3530	2890	2467	2042	2058	1826	1628	1483	1331	1211	1140	0.181
	6	3600	2180	2026	2466	2181	1945	1750	1587	1449	1332	1232	0.156
	7	3654	2283	2011	2380	2296	2007	1806	1687	1541	1421	1316	0.128
8	3738	2352	2006	2384	2402	2187	1958	1784	1646	1528	1428	0.119	

Example of Steel Deck Diaphragm Load Table for Interlocking Decks

Collated Metal Screws



PCSD Standing-Seam-Roofing Panel Clip Screw

Common Applications:

Standing-seam-roofing panel clips to steel or sheet-steel sheathing to cold-formed steel

Features:

- Pancake head
- #2 square drive (driver bit included in each box; replacement bit BIT2S; see p. 248 for more information)
- Drill point
- Straight collation
- Type 410 stainless steel is coated for additional corrosion protection
- This screw is also available in bulk for hand-drive installation; see p. 104 for details

Codes/Standards: ASTM C1513 compliant

Warning: Industry studies show that hardened fasteners can experience performance problems in wet or corrosive environments. Accordingly, use this product in dry, interior and noncorrosive environments only. For information on corrosion, materials and coatings, see pp. 17-21.

Quik Guard® Coating

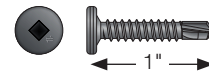

Length (in.)	Shank Size	#2 Drive Type	Threads Per Inch	Carton Quantity	Model No.	PRO PP150
1	#10	Undersized	16	1,500	PCSDQ1S1016	✓
1	#12	Undersized	14	1,500	PCSDQ1S1214	✓

Type 410 Stainless Steel*

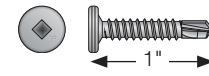

Length (in.)	Shank Size	#2 Drive Type	Threads Per Inch	Carton Quantity	Model No.	PRO PP150
1	#10	Standard	16	1,500	SSPCSD1S1016	✓

* These products are subject to quantities on hand or may require special ordering and are subject to minimum order quantities and longer lead times. Call Simpson Strong-Tie for details (800) 999-5099.

Clear Zinc Coating

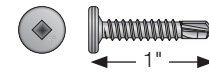

Length (in.)	Shank Size	#2 Drive Type	Threads Per Inch	Carton Quantity	Model No.	PRO PP150
1	#10	Standard	16	1,500	PCSD1S1016	✓
1	#12	Standard	14	1,500	PCSD1S1214	✓



Collated Metal Screws

CBSDQ Sheathing-to-CFS Screw

Common Applications:

Sheathing to cold-formed steel (Recommended thicknesses: 16 and 18 ga.)

Features:

- Ribbed flat head with nibs for easy countersinking
- #2 drill point with wings
- #2 undersized square drive (driver bit in each box; replacement bit model BIT2SU)
- Quik Guard® coating
- Curved collation

Codes/Standards: ASTM C1513 compliant, #8 screws meet minimum head diameter requirement per AISI S213-07, Lateral Design Standard.

For Technical Data and Loads, see p. 377

Warning: Industry studies show that hardened fasteners can experience performance problems in wet or corrosive environments. Accordingly, use this product in dry, interior and noncorrosive environments only.

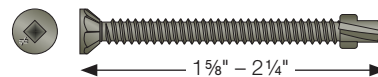

Quik Guard® Coating

Length (in.)	Shank Size	Threads Per Inch	Point Size	Carton Quantity	Min. Head Dia. (in.)	Model No.	PRO 200S	PRO 250	PRO 300S
1 5/8	#8	18	2	1,500	0.322	CBSDQ158S	✓	✓	✓
2 1/4	#10	16	2	1,000	0.322	CBSDQ214S		✓	✓



Collated Metal Screws

DWF Drywall-to-CFS Screw

Common Applications:

Drywall to cold-formed steel (Recommended thicknesses: 33, 27 and 18 mil / 20, 22 and 25 ga.)

Features:

- Bugle head
- #2 Phillips (driver bit in each box; replacement bit model BIT2P)
- Fine threads
- Sharp point
- Gray phosphate coating
- Curved collation

Codes/Standards: ASTM C1002-04 Type S compliant

For Technical Data and Loads, see p. 376



Gray Phosphate Coating

Length (in.)	Shank Size	Carton Quantity	Model No.	PRO200
1¼	#6	2,500	DWF114PS	✓
1½	#6	2,500	DWF158PS	✓

DWFSD Drywall-to-CFS Screw

Common Applications:

Drywall to cold-formed steel (Recommended max. steel thicknesses: 43 mil / 18 ga.)

Features:

- Bugle head
- #2 Phillips (driver bit in each box; replacement bit model BIT2P)
- Fine threads
- #2 drill point
- Curved collation

Codes/Standards: ASTM C954 compliant

For Technical Data and Loads, see p. 376

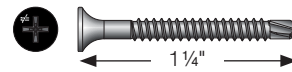

Quik Guard®

Length (in.)	Shank Size	Threads Per Inch	Box Quantity	Model No.	PRO 200S	PRO 200
1¼	#6	20	2,500	DWFSDQ114PS	✓	✓

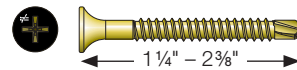

Yellow Zinc Coating

Length (in.)	Shank Size	Threads Per Inch	Box Quantity	Model No.	PRO 200S	PRO 250DW	PRO 200
1¼	#6	20	2,500	DWFSD114PS	✓		✓
1½	#6	20	2,500	DWFSD158PS	✓		✓
1¾	#6	20	2,000	DWFSD178PS	✓	✓	✓
2¾	#8	20	1,500	DWFSD238PS		✓	



Collated Metal Screws

FHSD Wood-to-CFS Screw

Common Applications:

Wood or wood structural panel sheathing to cold-formed steel to cold-formed steel (Recommended max. steel thicknesses: 3/16")

Features:

- Flat head
- Curved collation
- Type 410 stainless-steel screw has nibs under the head for easy countersinking
- 2 1/2" length has wings on the shaft to prevent jacking of the wood panel during installation
- Type 410 stainless steel is coated for additional corrosion protection
- #3 square drive for #10 (replacement bit BIT3S; see p. 248 for more information)
- #2 square drive for #8 (replacement bit BIT2S; see p. 248 for more information)

Codes/Standards: ASTM C1513 compliant; meets minimum head diameter requirements per AISI S213-07, lateral design standard.

For Technical Data and Loads, see p. 377

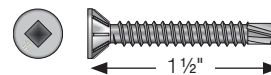

Type 410 Stainless Steel*

Length (in.)	Shank Size	Threads Per Inch	Point Size	Carton Quantity	Min. Head Dia. (in.)	Model No.	PRO PP150G2
1 1/2	#10	16	3	1,000	0.382	SSFHSD112S1016	✓

* These products are subject to quantities on hand or may require special ordering and are subject to minimum order quantities and longer lead times. Call Simpson Strong-Tie for details (800) 999-5099.

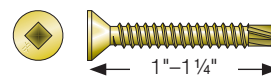

Yellow Zinc Coating

Length (in.)	Shank Size	Threads Per Inch	Point Size	Carton Quantity	Min. Head Dia. (in.)	Model No.	PRO 200S	PRO 200
1 1/4	#8	18	2	2,500	0.310	FHSD114S0818	✓	✓
1	#10	18	2	2,500	0.340	FHSD1S1018	✓	

WSFLRV Wood-to-CFS/Aluminum Screw

Common Applications:

Wood or wood structural panel sheathing to cold-formed steel (Recommended max steel thicknesses: 20 gauge), Wood to aluminum (Recommended max. aluminum thicknesses: 3/16")

Features:

- Flat head with nibs for easy countersinking
- #3 square drive (driver bit in each box; replacement bit model BIT3S)
- Fine threads
- Type-17 point
- Yellow zinc coating
- Curved collation

Codes/Standards: ASTM C1513 compliant; meets AISI S213 minimum for sheathing attachment if t <= 54 mil.

For Technical Data and Loads, see p. 377

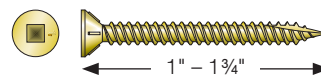

Yellow Zinc Coating

Length (in.)	Shank Size	Carton Quantity	Min. Head Dia. (in.)	Model No.	PRO 200S	PRO 200	PRO 250
1	#8	2,500	0.327	WSF1LRVS	✓	✓	
1 3/4	#8	2,000	0.327	WSF134LRVS	✓	✓	✓



Strong-Drive® SDS HEAVY-DUTY CONNECTOR Screw

**Tested performance.
Time-saving installation.**



Technical Information



- General Material Safety Data Note286
- General Load Tables287
- Strong-Drive® SDWS FRAMING Screw.....288
- Strong-Drive® SDWS TIMBER Screw292
- Outdoor Accents® Structural Wood Screw.....306
- Outdoor Accents® Connector Screw307
- Strong-Drive® SDWS LOG Screw308
- Strong-Drive® SDWH TIMBER-HEX Screw.....311
- Strong-Drive® SDWH TIMBER-HEX HDG Screw321
- Strong-Drive® SDWH TIMBER-HEX SS Screw324
- Fastener Types for Connectors327
- Strong-Drive® SDS HEAVY-DUTY CONNECTOR Screw ...329
- Strong-Drive® SD CONNECTOR Screw334
- Strong-Drive® SCNR RING-SHANK CONNECTOR Nail...337
- Strong-Drive® SCN SMOOTH-SHANK CONNECTOR Nail...338
- Wafer-Head Screw.....339
- Strong-Drive® SDWC TRUSS Screw.....340
- Strong-Drive® SDWF FLOOR-TO-FLOOR Screw.....352
- Strong-Drive® SDW TRUSS-PLY and EWP-PLY Screws ...356
- Strong-Drive® SDWV SOLE-TO-RIM Screw.....364
- Strong-Drive® TB WOOD-TO-STEEL Screw.....365
- Strong-Drive® WSNTL SUBFLOOR Screw.....366
- Strong-Drive® XE EXTERIOR STRUCTURAL METAL Screw .370
- Strong-Drive® PPSD SHEATHING-TO-CFS Screw.....371
- Strong-Drive® PHSD FRAMING-TO-CFS Screw372
- Strong-Drive® FPHSD FRAMING-TO-CFS Screw373
- Self-Drilling E Metal Screw374
- PC/PCSD Screws375
- PCSD Standing-Seam-Roofing Panel Clip Screw376
- DWF/DWFSD Screws376
- PPSD/CBSDQ/FHSD/WSFLRV Screws377
- Steel-Deck Fastening378
- Strong-Drive® SELF-DRILLING X METAL Screw380
- Strong-Drive® XL LARGE-HEAD
and XM MEDIUM-HEAD METAL Screws381
- Steel Deck Diaphragm Calculator383

General Material Safety Data (SDS) Note

Safety Data Sheets (SDS)

For Fasteners

Simpson Strong-Tie Company Inc. manufactures and sells fasteners, metal connectors and mechanical concrete anchors. Fastener products include and are not limited to nails, screws and staples. For the purpose of hazard communication, fastener products are “Articles” as defined in 29 CFR 1910.1200(c):

“Article means a manufactured item other than a fluid or particle: (i) which is formed to a specific shape or design during manufacture; (ii) which has end use function(s) dependent in whole or in part upon its shape or design during end use; and (iii) which under normal conditions of use does not release more than very small quantities, e.g., minute or trace amounts of a hazardous chemical (as determined under paragraph (d) of this section), and does not pose a physical hazard or health risk to employees.”

As Articles, fastener products are exempt from Safety Data Sheet (SDS) requirements under the Hazard Communication Standard (29 CFR 1910.1200(b)(6)(v)). For this reason, Simpson Strong-Tie does not have available MSDS sheets for its fastener products.

This information is current as of the date of this publication and is subject to change without notice. See strongtie.com for possible updates.

General Load Tables

Screw Strength

Model No.	Screw Size	Nominal Strength (lb.)		Load Resistance Factor Design (LRFD) (lb.)		Allowable Stress Design (ASD) (lb.)	
		Shear	Tension	Shear	Tension	Shear	Tension
		P_{ss}	P_{ts}	ϕP_{ss}	ϕP_{ts}	P_{ss}/Ω	P_{ts}/Ω
Steel to Steel							
FPHSD34S1016	#10 x ¾"	1,710	2,215	855	1,110	570	740
FPHSD34S1214	#12 x ¾"	2,535	3,380	1,265	1,690	845	1,125
PHSD34S0818	#8 x ¾"	1,495	1,810	750	905	500	605
E1B1414	#14 x 1"	3,130	5,395	1,565	2,700	1,045	1,800
XEQ34B1016	#10 x ¾"	1,390	2,350	695	1,175	465	785
Steel Decking							
X1S1016	#10 x 1"	1,625	2,930	810	1,465	540	975
X1S1214	#12 x 1"	2,525	3,750	1,265	1,875	840	1,250
XQ114S1224	#12 x 1¼"	2,800	4,260	1,400	2,130	935	1,420
XQ112S1224	#12 x 1½"	2,800	4,260	1,400	2,130	935	1,420
XMQ114S1224	#12 x 1¼"	3,110	4,985	1,555	2,495	1,035	1,660
XLQ114T1224	#12 x 1¼"	3,110	4,985	1,555	2,495	1,035	1,660
Metal-Roofing Clip to Steel							
PCSD1S1016	#10 x 1"	1,705	2,380	850	1,190	570	795
PCSD1S1214	#12 x 1"	1,760	3,180	880	1,590	585	1,060
SSPCSD1S1016	#10 x 1"	1,892	3,045	985	1,588	631	1,015
Metal-Roofing Clip to Wood							
PC1BS1012	#10-12 x 1"	1,415	2,080	710	1,040	470	695
PC1BS1211	#12-11 x 1"	1,715	3,080	860	1,540	570	1,025
Drywall							
DWF114PS	#6 x 1¼"	1,255	1,575	630	790	420	525
DWF158PS	#6 x 1½"	1,255	1,575	630	790	420	525
DWFSDQ114PS	#6 x 1¼"	1,260	1,720	630	860	420	575
DWFSD158PS	#6 x 1½"	1,260	1,720	630	860	420	575
DWFSDQ114PS	#6 x 1¼"	1,260	1,720	630	860	420	575
DWFSD178PS	#6 x 1¾"	1,260	1,720	630	860	420	575
DWFSD238PS	#8 x 2¾"	1,260	1,720	630	860	420	575
Wood to Steel							
FHSD114S0818	#8 x 1¼"	1,221	1,884	637	983	407	628
SSFHSD112S1016	#10 x 1½"	2,275	3,435	1,140	1,720	760	1,145
PPSD11516S0818	#8 x 1 15/16"	1,565	2,160	785	1,080	520	720
TB1445S	#14 x 1¼"	3,690	4,625	1,845	2,315	1,230	1,540
TB1460S	#14 x 2¾"	3,690	4,625	1,845	2,315	1,230	1,540
TB1475S	#14 x 3"	3,690	4,625	1,845	2,315	1,230	1,540

1. Table based on testing per AISI Standard Test Method S904-08.
2. Factor of Safety (Ω), and Resistance Factor (ϕ) are determined per AISI S100-07 Section F1.
3. P_{ss} and P_{ts} are nominal shear strength and nominal tension strength values for the screw, respectively, and are also known as the average (ultimate) values of all tests; determined by independent laboratory testing.

Load Tables, Technical Data and Installation Instructions

Strong-Drive® SDWS FRAMING Screw

Multipurpose Wood-To-Wood Including Framing, Indoor/Outdoor Projects

The framing connections with the SDWS FRAMING screws are designed for common framing connections, per the 2012 and 2015 IRC and IBC code requirements and are based on engineering analysis.

Codes/Standards: IAPMO-UES ER-192, State of Florida FL13975

For More Product Information, see p. 68

U.S. Patent Pending

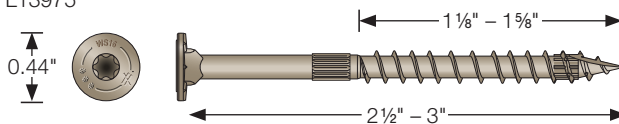

Walls

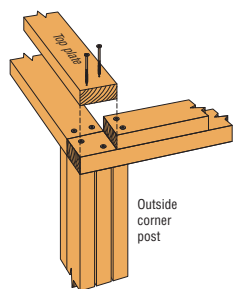

Double Top Plate at Corners

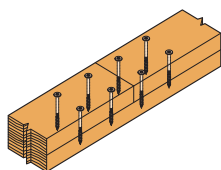

Double Top Plate Laps (Face Screw)

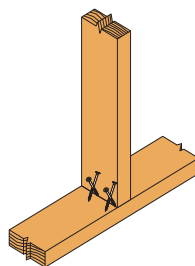

Stud to Sole Plate (Toe Screw)

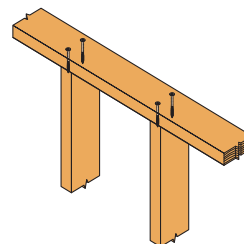

Top or Sole Plate to Stud (End Screw)

Connection Application	Fastener Quantities			
	IRC		IBC	
	Nails per Table R602.3 (1)	Equivalent SDWS Framing Screws	Nails per Table 2304.9.1	Equivalent SDWS Framing Screws
Top or sole plate to stud (end screw)	(2) 16d box	(2) SDWS16212	(2) 16d common	(2) SDWS16300
Stud to sole plate (toe screw)	(2) 16d box	(2) SDWS16212	(4) 8d common	(4) SDWS16212
Double top plate laps (face screw)	(8) 16d box	(8) SDWS16212	(8) 16d common	(8) SDWS16300
Double top plate at corners and intersections (face screw)	(2) 10d box	(2) SDWS16212	(2) 16d common	(2) SDWS16212
Double studs (face screw)	10d box 24" o.c.	SDWS16212 24" o.c.	16d box 24" o.c.	SDWS16300 24" o.c.

Ceiling

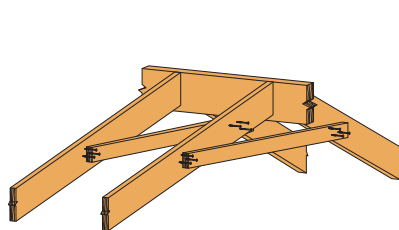

Collar Tie to Rafter (Face Screw)

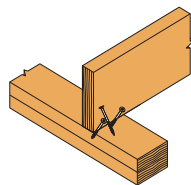

Ceiling Joist to Plate (Toe Screw)

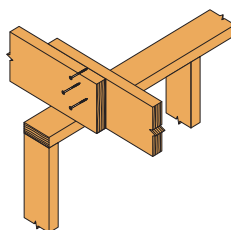

Ceiling Joist, Laps Over Partitions (Face Screw)

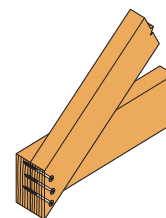

Ceiling Joist to Parallel Rafter (Face Screw)

Connection Application	Fastener Quantities			
	IRC		IBC	
	Nails per Table R602.3 (1) and R802.5.1 (9)	Equivalent SDWS Framing Screws	Nails per Table 2304.9.1 and 2308.10.4.1	Equivalent SDWS Framing Screws
Ceiling joist to plate (toe screw)	(3) 8d box	(3) SDWS16212	(3) 8d common	(3) SDWS16212
Ceiling joists, lap over partitions (face screw)	(3 min*) 10d box	(3 min*) SDWS16212	(3 min*) 16d common	(3 min*) SDWS16300
Collar tie to rafter (face screw)	(3) 10d box	(3) SDWS16212	(3) 10d common	(3) SDWS16300
Ceiling joist to parallel rafters (face screw)	(3) 16d common*	(3) SDWS16300*	(3 min*) 16d common	(3 min*) SDWS16300

* Quantities vary based on project conditions. The SDWS16300 is a 1-for-1 replacement for 16d common nails.

Load Tables, Technical Data and Installation Instructions

Strong-Drive® SDWS FRAMING Screw (cont.)

Roof

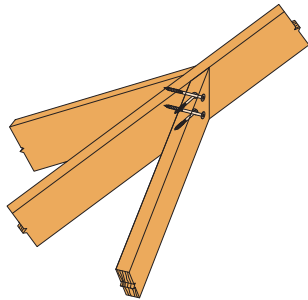

**Jack Rafter to Hip
(Toe Screw)**

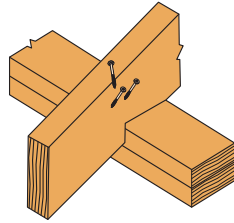

**Roof Rafter to Plate
(Toe Screw)**

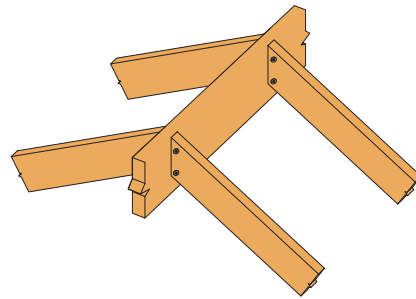

**Roof Rafter to 2x Ridge Board
(Toe Screw)**

Connection Application	Fastener Quantities			
	IRC		IBC	
	Nails per Table R602.3 (1)	Equivalent SDWS Framing Screws	Nails per Table 2304.9.1	Equivalent SDWS Framing Screws
Roof rafter to plate (toe screw)	(3) 10d common	(3) SDWS16212	(3) 8d common	(3) SDWS16212
Roof rafter to 2x ridge board (toe screw)	(4) 16d box	(4) SDWS16212	(2) 16d common	(2) SDWS16300
Jack rafter to hip (toe screw)	(4) 16d box	(4) SDWS16212	(3) 10d common	(3) SDWS16300

Floor

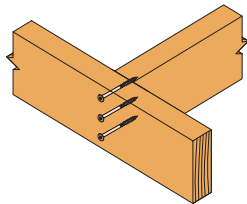

**Joist to Rim Board
(End Screw)**

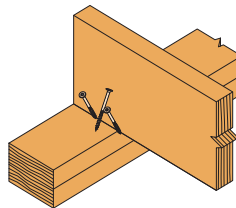

**Joist to Sill or Girder
(Toe Screw)**

Connection Application	Fastener Quantities			
	IRC		IBC	
	Nails per Table R602.3 (1)	Equivalent SDWS Framing Screws	Nails per Table 2304.9.1	Equivalent SDWS Framing Screws
Joist to band joist (end screw)	(3) 16d common end nail	(3) SDWS16300	(3) 16d common	(3) SDWS16300
Joist to sill or girder (toe screw)	(3) 8d box	(3) SDWS16212	(3) 8d common	(3) SDWS16212

Beam

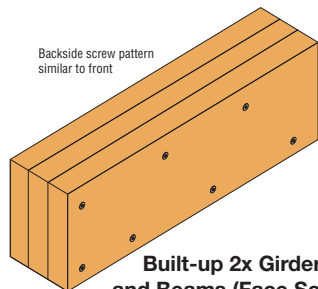

**Built-up 2x Girders
and Beams (Face Screw)**

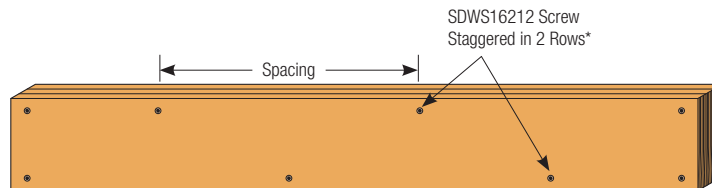

Beam Assembly Detail*

Connection Application	Fastener Quantities and Spacing			
	IRC		IBC	
	Nails per Table R602.3 (1)	Equivalent SDWS Framing Screws	Nails per Table 2304.9.1	Equivalent SDWS Framing Screws
Built-up 2x girders and beams (Face screw)	10d box 32" o.c. (24" o.c. per 2015)	SDWS16212 32" o.c.	10d box 24" o.c.	SDWS16212 24" o.c.

*Fastening pattern shown applies to each ply of the built-up 2x beam.

Load Tables, Technical Data and Installation Instructions

Strong-Drive® SDWS FRAMING Screw (cont.)

Deck

Connection Application	Fastener Quantities			
	IRC		IBC	
	Nails per Table R602.3 (1)	Equivalent SDWS Framing Screws	Nails per Table 2304.9.1	Equivalent SDWS Framing Screws
Rim joist to end joist (End screw)	(3) 16d common	(3) SDWS16300	(3) 16d common	(3) SDWS16300

*Per American Wood Council, DCA6, 2014.

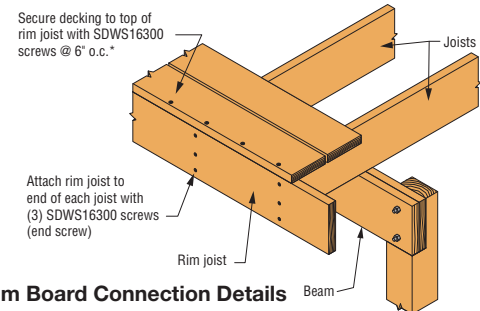

SDWS Framing Screw – Allowable Shear Loads for Sawn Lumber

Model No.	Side Member Thickness (in.)	Main Member Penetration (in.)	Allowable Shear Loads (lb.)		
			SP	DF	SPF/HF
SDWS16212	1 ½	0.90	131	106	99
SDWS16300	1 ½	1.40	229	150	150
	2	0.90	—	129	89

- All applications are based on full penetration into the main member. Full penetration is the screw length minus the side member thickness.
- Allowable loads are shown at the wood load duration factor of $C_D = 1.0$. Loads may be increased for load duration per the building code up to a $C_D = 1.6$. Tabulated values must be multiplied by all applicable adjustment factors per the NDS.
- Minimum fastener spacing requirements to achieve table loads; 2" (SDWS16212) and 3" (SDWS16300) end distance, ½" (SDWS16212) and 1" (SDWS16300) edge distance, 7/16" between staggered rows of fasteners, 1" between non-staggered and 4" between fasteners in a row.
- For in-service moisture content greater than 19% use $C_M = 0.70$.
- Screws must be installed straight into the side grain of the wood main member with the screw axis at a 90 degree angle to the wood fibers.

SDWS Framing Screw– Allowable Withdrawal Load in Sawn Lumber

Model No.	Fastener Length (in.)	Thread Length (in.)	Reference Withdrawal Design Loads, W (lb./in.)			Max. Reference Withdrawal Design Loads, W_{max} (lb.)		
			SP	DF	SPF/HF	SP	DF	SPF/HF
SDWS16212	2.40	1.250	177	132	103	199	149	116
SDWS16300	2.90	1.625	192	125	122	310	205	200

- The tabulated reference withdrawal design values (W) are in pounds per inch of the thread penetration into the main member.
- The tabulated reference withdrawal design values (W_{max}) are in pounds where the entire thread length must penetrate into the main member.
- Tabulated reference withdrawal design values (W) and (W_{max}) are shown at a $C_D = 1.0$. Loads may be increased for load duration per the building code up to a $C_D = 1.6$. Tabulated values must be multiplied by all applicable adjustment factors from the NDS as referenced in the IBC or IRC.
- Values are based on the lesser of withdrawal from the main member or pull-through of a 1 ½" side member. For in-service moisture content greater than 19% use $C_M = 0.65$.

SDWS Framing Screw– Allowable Shear Loads for Wood Structural Panel Side Member

Model No.	Side Member Thickness (in.)	Min. Main Member Penetration (in.)	Allowable Shear Loads (lb.)		
			SP	DF	SPF/HF
SDWS16	15/32	1.93	143	143	143
	23/32	1.68	200	187	138

- Allowable loads are shown at the wood load duration factor of $C_D = 1.0$. Loads may be increased for load duration per the building code up to a $C_D = 1.6$. Tabulated loads must be multiplied by all applicable adjustment factors per the NDS.
- WSP side members for tests was oriented strand board (equivalent specific gravity = 0.50).
- All applications are based on full penetration into the main member. Full penetration is the screw length minus the side member thickness.
- Screws must be installed straight into the side grain of the wood main member with the screw axis at a 90-degree angle to the wood fibers.

SDWS Framing Screw– Allowable Pull-Through Loads for Wood Structural Panel Side Member

Model No.	Side Member Thickness (in.)	Allowable Pull-Through Loads (lb.)
SDWS16	15/32	84
	23/32	169

- Allowable loads are shown at the wood load duration factor of $C_D = 1.0$. Loads may be increased for load duration per the building code up to a $C_D = 1.6$. Tabulated loads must be multiplied by all applicable adjustment factors per the NDS.
- WSP side members for tests was oriented strand board (equivalent specific gravity = 0.50).
- For connections with 15/32" and 23/32" thick OSB side members, the lesser of withdrawal loads from the main and pull-through loads from WSP side member shall be used in design.

Load Tables, Technical Data and Installation Instructions

Strong-Drive® SDWS FRAMING Screw (cont.)

Typical Conventional Framing Connections

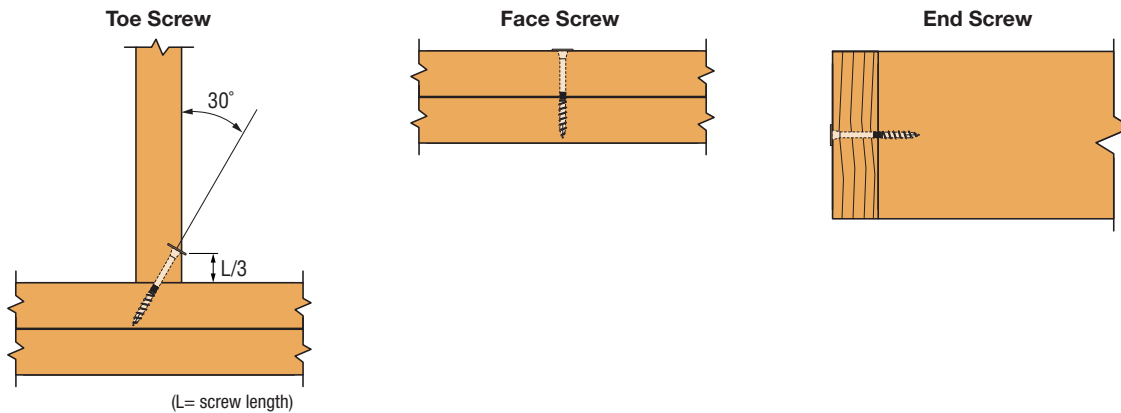

Strong-Drive® SDWS Framing Screw Spacing Requirements for Non-Prescriptive Construction

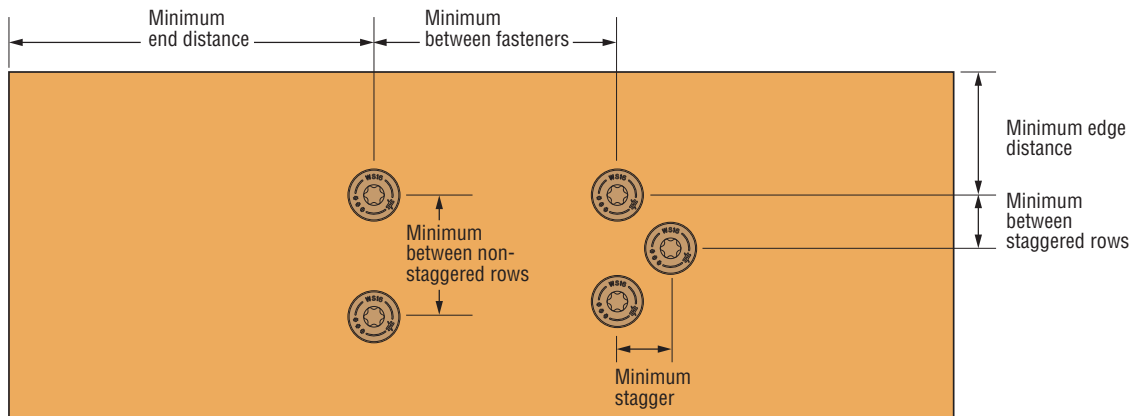

SDWS Framing Screw Spacing Requirements

Condition		Minimum Distance or Spacing (in.)	
		SDWS16212	SDWS16300
End distance	Loading toward end	2	3
	Loading away from end	2	3
	Loading perpendicular to grain	3½	4
Edge distance	Loading parallel to grain	½	1
	Loading perpendicular to grain	1	1
Spacing between fasteners in a row	Loading parallel to grain	2	2
	Loading perpendicular to grain	2	2
Spacing between rows	In-line rows*	1	1
	Staggered rows	7/16	7/16

*Table loads must be multiplied by adjustment factors of 0.93 (SDWS16212) and 0.91 (SDWS16300).

Load Tables, Technical Data and Installation Instructions

Strong-Drive® SDWS TIMBER Screw

Structural Wood-to-Wood Connections Including Ledgers

Designed to provide an easy-to-install, high-strength alternative to through-bolting and traditional lag screws. The Strong-Drive® SDWS Timber screws are ideal for the contractor and do-it-yourselfer alike.

Double-barrier coating provides corrosion resistance equivalent to hot-dip galvanization, making it suitable for certain exterior and preservative-treated wood applications, as described in the evaluation report.

Codes/Standards: IAPMO-UES ER-192, State of Florida FL13975;

U.S. Patents 5,897,280; 7,101,133

For More Product Information, see p. 69

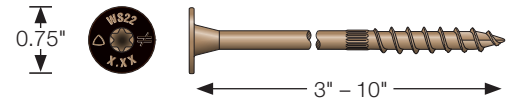

SDWS Timber Screw – Allowable Shear Loads – Douglas Fir-Larch and Southern Pine Lumber

Size Dia. x L (in.)	Model No.	Thread Length (in.)	DF/SP Allowable Shear Loads (lb.)									
			Wood Side Member Thickness (in.)									
			1.5	2	2.5	3	3.5	4	4.5	6	8	
0.22 x 3	SDWS22300DB	1½	255	—	—	—	—	—	—	—	—	—
0.22 x 4	SDWS22400DB	2¾	405	405	305	—	—	—	—	—	—	—
0.22 x 5	SDWS22500DB	2¾	405	405	360	360	325	—	—	—	—	—
0.22 x 6	SDWS22600DB	2¾	405	405	405	405	365	365	355	—	—	—
0.22 x 8	SDWS22800DB	2¾	405	405	405	405	395	395	395	395	—	—
0.22 x 10	SDWS221000DB	2¾	405	405	405	405	395	395	395	395	395	395

See footnotes below.

SDWS Timber Screw – Allowable Shear Loads – Spruce-Pine-Fir and Hem-Fir Lumber

Size Dia. x L (in.)	Model No.	Thread Length (in.)	SPF/HF Allowable Shear Loads (lb.)									
			Wood Side Member Thickness (in.)									
			1.5	2	2.5	3	3.5	4	4.5	6	8	
0.22 x 3	SDWS22300DB	1½	190	—	—	—	—	—	—	—	—	—
0.22 x 4	SDWS22400DB	2¾	385	285	215	—	—	—	—	—	—	—
0.22 x 5	SDWS22500DB	2¾	405	290	290	290	195	—	—	—	—	—
0.22 x 6	SDWS22600DB	2¾	405	365	365	365	310	310	210	—	—	—
0.22 x 8	SDWS22800DB	2¾	405	365	365	365	310	310	280	280	—	—
0.22 x 10	SDWS221000DB	2¾	405	365	365	365	310	310	280	280	280	280

- All applications are based on full penetration into the main member. Full penetration is the screw length minus the side member thickness.
- Allowable loads are shown at the wood load duration factor of $C_D = 1.0$. Loads may be increased for load duration per the building code up to a $C_D = 1.6$. Tabulated values must be multiplied by all applicable adjustment factors per the NDS.
- Minimum fastener spacing requirements to achieve table loads: 6" end distance, 1 7/16" edge distance, 5/8" between staggered rows of fasteners, 4" between non-staggered rows of fasteners and 8" between fasteners in a row.
- For in-service moisture content greater than 19%, use $C_M = 0.7$.
- Loads are based on installation into the side grain of the wood with the screw axis perpendicular to the face of the member.

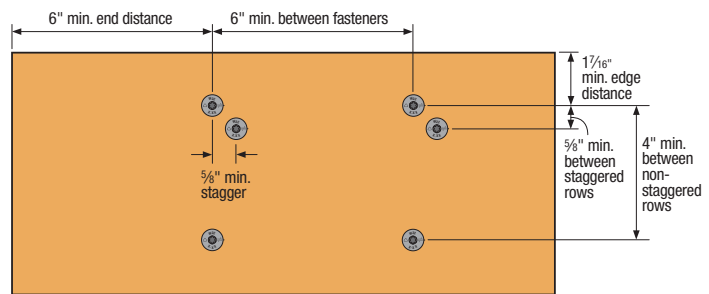

SDWS Timber Screw Spacing Requirements

SDWS Timber Screw – Allowable Withdrawal Loads – Douglas Fir-Larch, Southern Pine, Spruce-Pine-Fir and Hem-Fir Lumber

Model No.	Fastener Length (in.)	Thread Length (in.)	Reference Withdrawal Design Value, W (lb./in.)		Max. Reference Withdrawal Design Value, W _{Max} (lb.)	
			DF and SP Main Member	HF and SPF Main Member	DF and SP Main Member	HF and SPF Main Member
SDWS22300DB	3	1½	164	151	245	225
SDWS22400DB	4	2¾	179	160	425	380
SDWS22500DB	5	2¾	214	187	590	495
SDWS22600DB	6	2¾	214	187	590	495
SDWS22800DB	8	2¾	214	187	590	495
SDWS221000DB	10	2¾	214	187	590	495

- The tabulated reference withdrawal design value, W , is in pounds per inch of the thread penetration into the side grain of the main member.
- The tabulated reference withdrawal design value, W_{Max} , is in pounds where the entire thread length must penetrate into the side grain of the main member.
- Tabulated reference withdrawal design values, W and W_{Max} , are shown at a $C_D = 1.0$. Loads may be increased for load duration per the building code up to a $C_D = 1.6$. Tabulated values must be multiplied by all applicable adjustment factors from the NDS as referenced in the IBC or IRC.
- Embedded thread length is that portion held in the main member including the screw tip.
- Values are based on the lesser of withdrawal from the main member or pull-through of a 1 1/2" side member.
- For in-service moisture content greater than 19%, use $C_M = 0.7$.

Load Tables, Technical Data and Installation Instructions

Strong-Drive® SDWS TIMBER Screw (cont.)

SDWS Timber Screw – 2012 and 2015 IRC Compliant Spacing
for a Sawn Lumber Deck Ledger to Rim Board

Loading Condition	Nominal Ledger Size (in.)	Model No.	Rim Board Material and Minimum Size	Maximum Deck Joist Span						
				Up to 6 ft.	Up to 8 ft.	Up to 10 ft.	Up to 12 ft.	Up to 14 ft.	Up to 16 ft.	Up to 18 ft.
				Maximum On-Center Spacing of Fasteners (in.)						
40 psf Live 10 psf Dead	2x	SDWS22400DB	1" OSB	14	10	8	7	6	5	5
			1" LVL							
			1 1/8" OSB	16	12	10	8	7	6	5
			1 5/16" LVL							
			1 1/4" LSL							
2x SP, DF – 2x SPF, HF	22	16	13	11	9	8	7			
60 psf Live 10 psf Dead	2x	SDWS22400DB	1" OSB	10	7	6	5	4	4	—
			1" LVL							
			1 1/8" OSB	12	9	7	6	5	4	4
			1 5/16" LVL							
			1 1/4" LSL							
2x SP, DF – 2x SPF, HF	15	12	9	8	7	6	5			
40 psf Live 10 psf Dead	(2) 2x	SDWS22500DB	1" OSB	15	12	9	8	7	6	5
			1" LVL							
			1 1/8" OSB	16	12	10	8	7	6	5
			1 5/16" LVL							
			1 1/4" LSL							
2x SP, DF – 2x SPF, HF	16	12	10	8	7	6	5			
60 psf Live 10 psf Dead	(2) 2x	SDWS22500DB	1" OSB	11	8	7	6	5	4	4
			1" LVL							
			1 1/8" OSB	12	9	7	6	5	4	4
			1 5/16" LVL							
			1 1/4" LSL							
2x SP, DF – 2x SPF, HF	12	9	7	6	5	4	4			

- SDWS screw spacing values are equivalent to 2012/2015 IRC Table R507.2. The table above also provides SDWS screw spacing for a wide range of materials commonly used for rim board, and an alternate loading condition as required by some jurisdictions.
- Sawn lumber rim board shall be Spruce-Pine-Fir, Hem-Fir, Douglas Fir-Larch, or Southern Pine species. Ledger shall be Hem-Fir, Douglas Fir-Larch, or Southern Pine species.
- Fastener spacings are based on the lesser of single fastener ICC-ES AC233 testing of the Strong-Drive® SDWS Timber screw with a safety factor of 5.0 or ICC-ES AC13 assembly testing with a factor of safety of 5.0. Spacing includes NDS wet service factor adjustment.
- Multiple ledger plies shall be fastened together per code independent of the SDWS screws.
- Rows of screws shall be vertically offset and evenly staggered. Screws shall be placed 1 1/2" to 2" from the top and bottom of the ledger or rim board with 3" minimum and 6" maximum between rows and spaced per the table. End screws shall be located 6" from the end and at 1 1/2" to 2" from the bottom of the ledger. For screws located at least 2" but less than 6" from the end, use 50% of the load per screw and 50% of the table spacing between the end screw and the adjacent screw, and for screws located between 2" and 4" from the end, predrill using a 5/16" drill.
- Structural sheathing between the ledger and rim board shall be a maximum of 1/2" thick and fastened per code.
- See p. 299 for ledger-to-rim attachment with 1/2" gap.

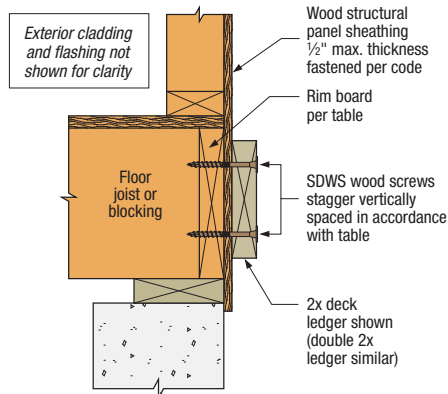

Ledger-to-Rim Board Assembly

(Wood-framed lower floor acceptable, concrete wall shown for illustration purposes)

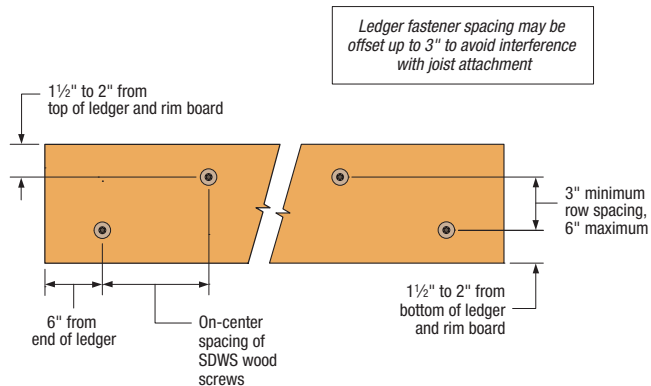

SDWS Timber Screw Spacing Detail for Ledgers

Load Tables, Technical Data and Installation Instructions

Strong-Drive® SDWS TIMBER Screw (cont.)

SDWS Timber Screw – Allowable Shear Loads for Sole-to-Rim Connections

Size (in.)	Model No.	Sole Plate Nominal Size (in.)	Minimum Penetration into Rim Board (in.)	Allowable Loads (lb.)							
				2x DF/SP Rim Board		2x SPF/HF Rim Board		1 1/4" Min. LVL Rim Board		1 1/4" Min. LSL Rim Board	
				DF/SP Sole Plate	SPF/HF Sole Plate	DF/SP Sole Plate	SPF/HF Sole Plate	DF/SP Sole Plate	SPF/HF Sole Plate	DF/SP Sole Plate	SPF/HF Sole Plate
0.22 x 4	SDWS22400DB	2x	1.75	345	295	295	295	275	275	275	275
0.22 x 5	SDWS22500DB	2x	2	345	295	295	295	275	275	275	275
0.22 x 6	SDWS22600DB	2x or 3x	2	345	295	295	295	275	275	275	275

1. Allowable loads are based on testing per ICC-ES AC233 and are limited to parallel-to-grain loading.
2. Allowable loads are shown at the wood load duration factor of $C_D = 1.00$. Loads may be increased for load duration by the building code up to a $C_D = 1.60$.
3. Minimum spacing of the SDWS is 6" o.c., minimum end distance is 6", and minimum edge distance is $\frac{5}{8}$ ".
4. Wood structural panel up to 1 1/8" thick ($\frac{3}{8}$ " for SDWS22400DB) is permitted between the sole plate and rim board provided it is fastened to the rim board per code and the minimum penetration of the screw into the rim board is met.
5. A double 2x sole plate is permitted provided it is independently fastened per the code and the minimum screw penetration per the table is met.

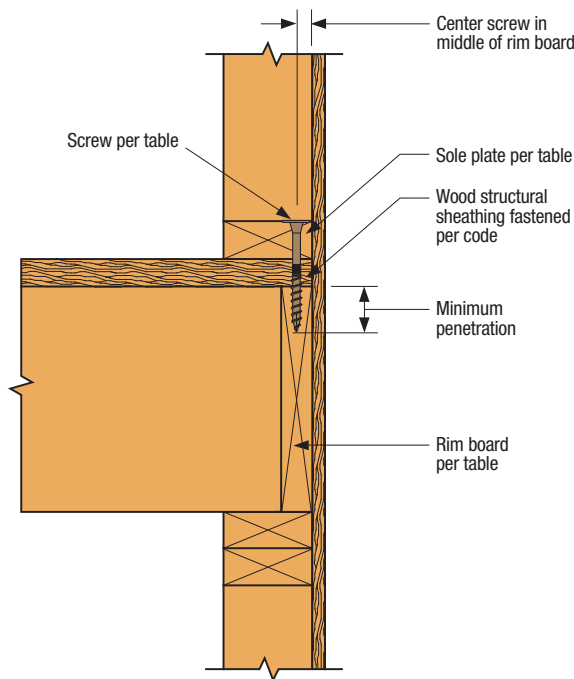

Sole-to-Rim Board Assembly

Load Tables, Technical Data and Installation Instructions

Strong-Drive® SDWS TIMBER Screw in Ledger-to-Stud Applications

Strong-Drive® SDWS Timber screws may be used to attach a ledger to the narrow face of nominal 2x lumber studs according to the following table. Tests and analyses were performed in accordance with ICC-ES Acceptance Criteria AC233.

SDWS Timber Screw – Allowable Shear Loads for Ledger Attachment to Studs

Model No.	Length (in.)	Ledger Nominal Size (in.)	Number of Screws per Stud	Allowable Shear Load (lb.)		
				DF	SPF/HF	SP
SDWS22400DB	4	2x6	2	630	565	785
		2x8	3	890	855	1,060
		2x10	4	1,040	1,040	—

- Allowable loads shall be limited to parallel-to-grain loaded solid sawn main members (minimum 2" nominal). Wood side members shall be loaded perpendicular to grain.
- Allowable loads are based on DF, SPF/HF, and SP wood members having a minimum specific gravity of 0.50, 0.42, and 0.55, respectively. Where the side and main members have different specific gravities, the lower values shall be used.
- Allowable loads are shown at the wood load duration factor of $C_D = 1.00$. Loads may be increased for load duration as permitted by the building code up to a $C_D = 1.60$. All adjustment factors shall be applied per the 2012 National Design Specification (NDS). For in-service moisture content greater than 19%, use $C_M = 0.70$.
- Fasteners shall be centered in the stud and spaced as shown in the figure. The stud minimum end distance is 6" when loaded toward the end and 2½" when loaded away from the end. The ledger end distance is 6" for full values. For ledger end distances between 2" and 6" use 50% of the table loads. For end distances between 2" and 4", predrill using a ⅜" bit for SDWS.
- Screws may be installed with an intermediate layer of wood structural panel between the side and main member provided the wood structural panel is fastened to the main member per code and the minimum screw penetration of 2½" into the main member (excluding the wood structural panel) is met. Longer lengths of the screw series may be used.
- For LRFD values, the reference connection design values shall be adjusted in accordance with the NDS-2012, section 10.3.
- For 2x10 SP ledgers, use the number of screws and allowable loads of the 2x8 SP ledger.
- For 2x8 ledgers with two screws, use 2x6 values. For 2x10 ledgers with three screws, use 2x8 values. Spacings and edge distances shown in the figure are minimum dimensions.
- For loads in the opposite direction from that shown in the figure, use the table values multiplied by: 0.50 for two screw connections, 0.67 for three screw connections, and 0.75 for four screw connections.

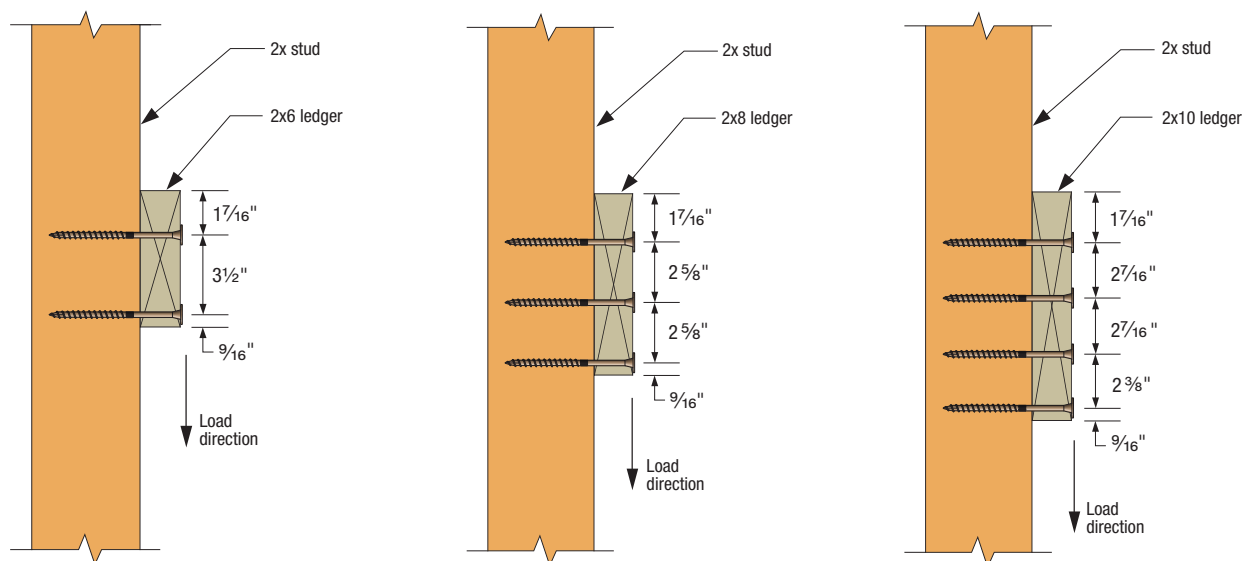

Load Tables, Technical Data and Installation Instructions

Strong-Drive® SDWS TIMBER Screw with Gypsum Board Interlayer(s)

The Strong-Drive® SDWS Timber screw may be installed with one or two layers of 5/8" gypsum board. This layer of gypsum is to be located between the side member and main member for a standard connection and between the ledger and sheathing of a ledger connection. See the tables below for the required screw lengths and allowable loads for these applications. Loads are derived from assembly testing based on ICC-ES AC233.

SDWS Timber Screw – Douglas Fir-Larch and Southern Pine Lumber Allowable Single Shear Loads with One Layer of 5/8" Gypsum Board

Size (in.)	Model No.	Thread Length (in.)	DF/SP Allowable Shear Loads (lb.)									
			Wood Side Member Thickness (in.)									
			1.5	2.0	2.5	3.0	3.5	4.0	4.5	6.0	8.0	
0.22 x 4	SDWS22400DB	2.375	265	—	—	—	—	—	—	—	—	—
0.22 x 5	SDWS22500DB	2.75	265	265	235	—	—	—	—	—	—	—
0.22 x 6	SDWS22600DB	2.75	265	265	265	265	235	—	—	—	—	—
0.22 x 8	SDWS22800DB	2.75	265	265	265	265	255	255	255	—	—	—
0.22 x 10	SDWS221000DB	2.75	265	265	265	265	255	255	255	255	—	—

See notes on following page.

SDWS Timber Screw – Douglas Fir-Larch and Southern Pine Lumber Allowable Single Shear Loads with Two Layers of 5/8" Gypsum Board

Size (in.)	Model No.	Thread Length (in.)	DF/SP Allowable Shear Loads (lb.)									
			Wood Side Member Thickness (in.)									
			1.5	2.0	2.5	3.0	3.5	4.0	4.5	6.0	8.0	
0.22 x 4	SDWS22400DB	2.375	—	—	—	—	—	—	—	—	—	—
0.22 x 5	SDWS22500DB	2.75	265	265	—	—	—	—	—	—	—	—
0.22 x 6	SDWS22600DB	2.75	265	265	265	265	—	—	—	—	—	—
0.22 x 8	SDWS22800DB	2.75	265	265	265	265	255	255	255	—	—	—
0.22 x 10	SDWS221000DB	2.75	265	265	265	265	255	255	255	255	—	—

See notes on following page.

SDWS Timber Screw – Spruce-Pine-Fir and Hem-Fir Lumber Allowable Single Shear Loads with One Layer of 5/8" Gypsum Board

Size (in.)	Model No.	Thread Length (in.)	SPF/HF Allowable Shear Loads (lb.)									
			Wood Side Member Thickness (in.)									
			1.5	2.0	2.5	3.0	3.5	4.0	4.5	6.0	8.0	
0.22 x 4	SDWS22400DB	2.375	250	—	—	—	—	—	—	—	—	—
0.22 x 5	SDWS22500DB	2.75	260	190	190	—	—	—	—	—	—	—
0.22 x 6	SDWS22600DB	2.75	260	235	235	235	200	—	—	—	—	—
0.22 x 8	SDWS22800DB	2.75	260	235	235	235	200	200	180	—	—	—
0.22 x 10	SDWS221000DB	2.75	260	235	235	235	200	200	180	180	—	—

See notes on following page.

Load Tables, Technical Data and Installation Instructions

Strong-Drive®

SDWS TIMBER Screw

with Gypsum Board Interlayer(s) (cont.)

SDWS Timber Screw – Spruce-Pine-Fir and Hem-Fir Lumber
Allowable Single Shear Loads with Two Layers of 5/8" Gypsum Board

Size (in.)	Model No.	Thread Length (in.)	SPF/HF Allowable Shear Loads (lb.)									
			Wood Side Member Thickness (in.)									
			1.5	2.0	2.5	3.0	3.5	4.0	4.5	6.0	8.0	
0.22 x 4	SDWS22400DB	2.375	—	—	—	—	—	—	—	—	—	—
0.22 x 5	SDWS22500DB	2.75	260	190	—	—	—	—	—	—	—	—
0.22 x 6	SDWS22600DB	2.75	260	235	235	235	—	—	—	—	—	—
0.22 x 8	SDWS22800DB	2.75	260	235	235	235	200	200	180	—	—	—
0.22 x 10	SDWS221000DB	2.75	260	235	235	235	200	200	180	180	—	—

- All applications are based on full penetration which equals fastener length minus side member thickness.
- Allowable loads are shown at the wood load duration factor of $C_D = 1.0$. Loads may be increased for load duration per the building code up to a $C_D = 1.6$. Tabulated values must be multiplied by all applicable adjustment factors per the NDS.
- Minimum fastener spacing requirements: 6" end distance, 1 7/16" edge distance, 5/8" between staggered rows of fasteners, 4" between non-staggered rows of fasteners and 8" between fasteners in a row. Refer to SDWS Spacing Requirements figure on p. 292.
- For in-service moisture content greater than 19% use $C_M = 0.7$.
- Gypsum board must be attached as required per the building code.

Load Tables, Technical Data and Installation Instructions

Strong-Drive®

SDWS TIMBER Screw with Gypsum Board Interlayer(s) (cont.)

SDWS Timber Screw – 2009, 2012 and 2015 IRC Compliant Spacing for a Sawn Lumber Ledger to Rim Board with One or Two Layers of 5/8" Gypsum Board

Loading Condition	Nominal Ledger Thickness (in.)	Model No.	Rim Board Material and Minimum Size	Maximum Deck Joist Span						
				Up to 6 ft.	Up to 8 ft.	Up to 10 ft.	Up to 12 ft.	Up to 14 ft.	Up to 16 ft.	Up to 18 ft.
				Maximum On-Center Spacing of Fasteners (in.)						
40 psf Live 10 psf Dead	2x	For one layer of gypsum board use: SDWS22400DB	1" OSB 1" LVL	13	10	8	6	6	5	4
			1 1/8" OSB 1 5/16" LVL 1 1/4" LSL	15	11	9	8	7	6	5
			2x SP, DFL 2x SPF, HF	20	15	12	10	9	8	7
60 psf Live 10 psf Dead	2x	For one layer of gypsum board use: SDWS22400DB	1" OSB 1" LVL	9	7	6	5	4	—	—
			1 1/8" OSB 1 5/16" LVL 1 1/4" LSL	11	8	7	5	5	4	4
			2x SP, DFL 2x SPF, HF	14	11	9	7	6	5	5
100 psf Live 10 psf Dead	2x	For one layer of gypsum board use: SDWS22400DB	1" OSB 1" LVL	6	4	4	—	—	—	—
			1 1/8" OSB 1 5/16" LVL 1 1/4" LSL	8	6	5	4	—	—	—
			2x SP, DFL 2x SPF, HF	9	7	5	5	4	—	—
40 psf Live 10 psf Dead	(2) 2x	For one layer of gypsum board use: SDWS22600DB	1" OSB 1" LVL	14	11	9	7	6	5	5
			1 1/8" OSB 1 5/16" LVL 1 1/4" LSL	15	11	9	8	7	6	5
			2x SP, DFL 2x SPF, HF	15	11	9	8	7	6	5
60 psf Live 10 psf Dead	(2) 2x	For one layer of gypsum board use: SDWS22600DB	1" OSB 1" LVL	10	8	6	5	5	4	—
			1 1/8" OSB 1 5/16" LVL 1 1/4" LSL	11	8	6	5	5	4	4
			2x SP, DFL 2x SPF, HF	11	8	6	5	5	4	4
100 psf Live 10 psf Dead	(2) 2x	For one layer of gypsum board use: SDWS22600DB	1" OSB 1" LVL	7	5	4	—	—	—	—
			1 1/8" OSB 1 5/16" LVL 1 1/4" LSL	7	5	4	—	—	—	—
			2x SP, DFL 2x SPF, HF	7	5	4	—	—	—	—

- Sawn rim board shall be Spruce-Pine-Fir, Hem-Fir, Douglas Fir-Larch, or Southern Pine species. Ledger shall be Hem-Fir, Douglas Fir-Larch, or Southern Pine species.
- Fastener spacings are based on the lesser of single fastener ICC-ES AC233 testing of the Strong-Drive® SDWS screw with a safety factor of 5.0 or ledger assembly testing based on ICC-ES AC13 with a factor of safety of 3.0. Spacing does NOT include NDS wet service factor adjustment.
- Multiple ledger plies shall be fastened together per code independent of the SDWS screws.
- SDWS screw spacing values are equivalent to 2009 IRC Table R502.2.2.1 and 2012/2015 IRC Table R507.2. The table also provides SDWS screw spacing for a wider range of materials commonly used for rim boards, and an alternate loading condition as required by some jurisdictions.
- Rows of screws shall be vertically offset and evenly staggered. Screws shall be placed 1 1/2" to 2" from the top and bottom of the ledger or rim board with 3" minimum and 6" maximum between rows and spaced per the table. End screws shall be located 6" from the end and at 1 1/2" to 2" from the bottom of the ledger. For screws located at least 2" but less than 6" from the end, use 50% of the load per screw and 50% of the table spacing between the end screw and the adjacent screw, and for screws located between 2" and 4" from the end, predrill using a 5/8" drill.
- The design installation permits a wood structural panel (WSP) interlayer in addition to one or two layers of gypsum board. If present, the WSP shall be a maximum of 1/2" thick, adjacent to the framing and fastened directly to the framing per the code.
- Gypsum board must be attached as required per the building code.

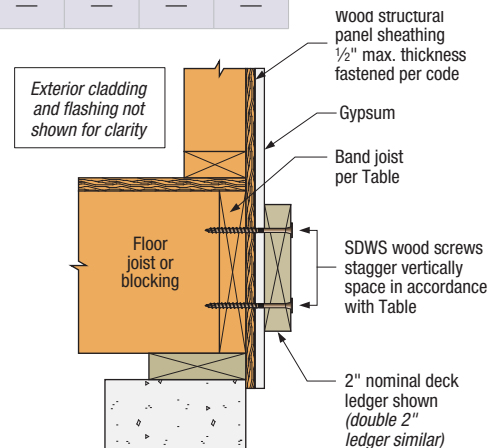

Ledger-to-Rim Board Assembly

(Wood-framed lower floor acceptable, concrete wall shown for illustration purposes)

Load Tables, Technical Data and Installation Instructions

Strong-Drive® SDWS TIMBER Screw with Gypsum Board Interlayer(s) (cont.)

SDWS Timber Screw – Allowable Shear Loads for Ledger Attachment to Studs with One or Two Layers of Gypsum Board

Model No.	Length (in.)	Ledger Size	Number of Screws per Stud	Allowable Shear Load (lb.)		
				DF	SPF/HF	SP
SDWS22600DB	6	2x6	2	410	365	510
		2x8	3	580	555	690
		2x10	4	675	675	—

- Allowable loads shall be limited to parallel-to-grain loaded solid sawn main members (minimum 2" nominal). Wood side members shall be loaded perpendicular to grain.
- Allowable loads are based on DF, SPF/HF, and SP wood members having a minimum specific gravity of 0.50, 0.42, and 0.55, respectively. Where the side and main members have different specific gravities, the lower values shall be used.
- Allowable loads are shown at the wood load duration factor of $C_D = 1.00$. Loads may be increased for load duration as permitted by the building code up to a $C_D = 1.60$. All adjustment factors shall be applied per the 2012 National Design Specification (NDS). For in-service moisture content greater than 19%, use $C_M = 0.70$.
- Fasteners shall be centered in the stud and spaced as shown in the figure. The ledger minimum end distance is 6". The stud minimum end distance is 6" when the load is toward the end and 2½" when the load is away from the end.
- Screws may be installed with an interlayer of wood structural panel (WSP) between the framing and the gypsum panel(s). When a WSP is present, it shall be a maximum of ½" thick, adjacent to the framing and fastened directly to the framing per code. Minimum screw penetration into the framing of 2½" shall be required; longer screw lengths shall be used to achieve the required penetration.
- For LRFD values, the reference connection design values shall be adjusted in accordance with the NDS2012, section 10.3, or NDS-15, section 11.3.
- For 2x10 SP ledgers, use the number of screws and allowable loads of the 2x8 SP ledger.
- For 2x8 ledgers with two screws, use 2x6 values. For 2x10 ledgers with three screws, use 2x8 values. Spacings and edge distances shown in the figure are minimum dimensions.
- For loads in the opposite direction from that shown in the figure, use the table values multiplied by: 0.50 for two screw connections, 0.67 for three screw connections, and 0.75 for four screw connections.
- Gypsum board must be attached as required per the building code.
- For ledger end distances between 2" and 6", use 50% of load and pre-drill with ⅜" drill bit.

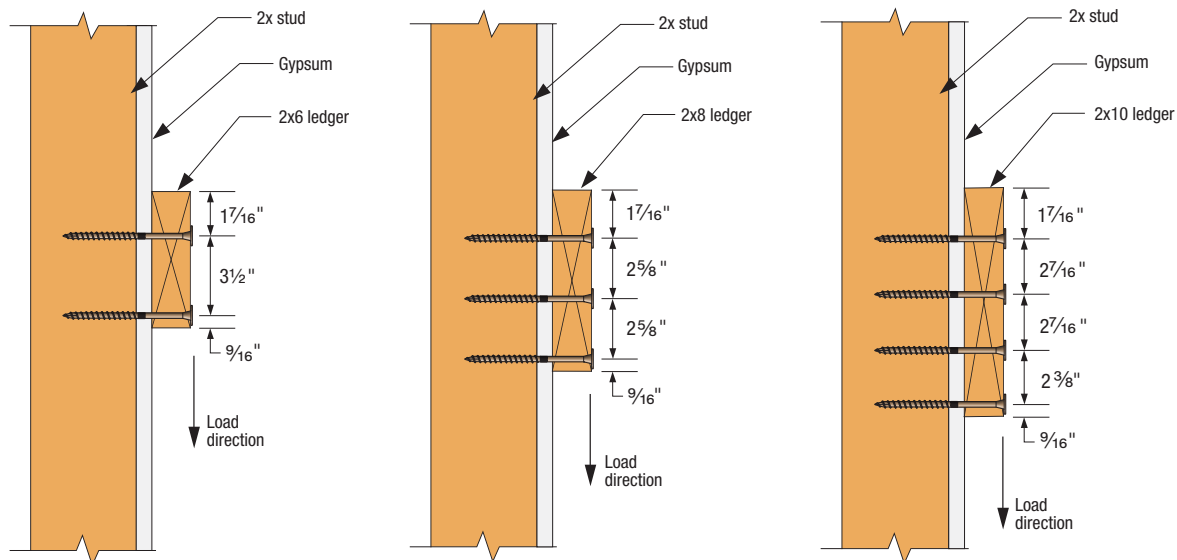

Notes to Installer Regarding the Attachment of Ledgers to Studs:

The screws must be installed into the middle of the stud with a tolerance of ⅜" either side of center. Various methods can be used to ensure proper placement of the screws in the stud including snapping a chalk line, using a stud finder or prerocking (attaching only a strip of gypsum at the ledger location until the ledger is fastened to the studs). If proper screw placement into the stud cannot be achieved in the field, blocking should be installed between studs to receive and support the ledger screws.

Load Tables, Technical Data and Installation Instructions

Strong-Drive® SDWS TIMBER Screw for Guard Post Installations

The SDWS Timber screws are tested in accordance with ICC-ES AC273 and met the 500 lb. concentrated ultimate load applied at the top of a single post in an outward direction and the post deflection limit at the 200 lb. design level. The following details were tested:

- Detail A: Interior Post on Rim Board
- Detail B: Interior Post at Corner
- Detail C: Interior Post on Rim Joist with Adjacent Joist
- Detail D: Interior Post on Rim Joist between Joists

The SDWS Timber screws are the subject of IAPMO-UES ER-192. The following table lists the SDWS Timber screw information and total quantity of fasteners required for each guard post detail. The guard post details are shown on pp. 301–303.

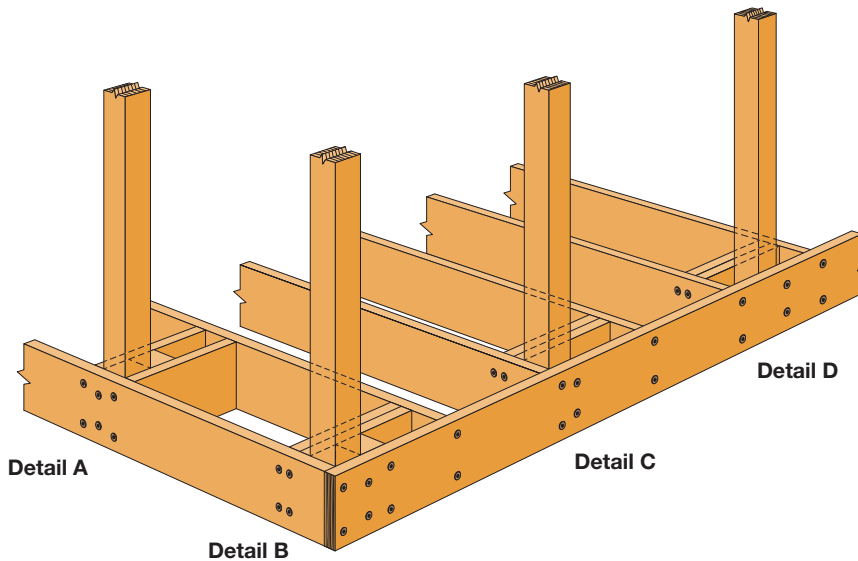

**Internal Guard Post Installations Using
Strong-Drive® SDWS Timber Screws**

Code-Compliant Guard Post Connection Details

Installation Scope:

- Maximum 36" guard post height (above deck surface)
- Nominal 4"x4" guard post
- Nominal 2"x8" rim board/rim joist minimum, 2x blocking and 4x blocking
- HF, DFL or SP lumber pressure treated with chemical retention not greater than UC4A.
- Full-depth blocking required
- Internal post installation (post positioned inside of the rim board, rim joist)
- Fastener position tolerance: $\pm 1/16$ "

Load Tables, Technical Data and Installation Instructions

Strong-Drive®

SDWS TIMBER Screw

for Guard Post Installations (cont.)

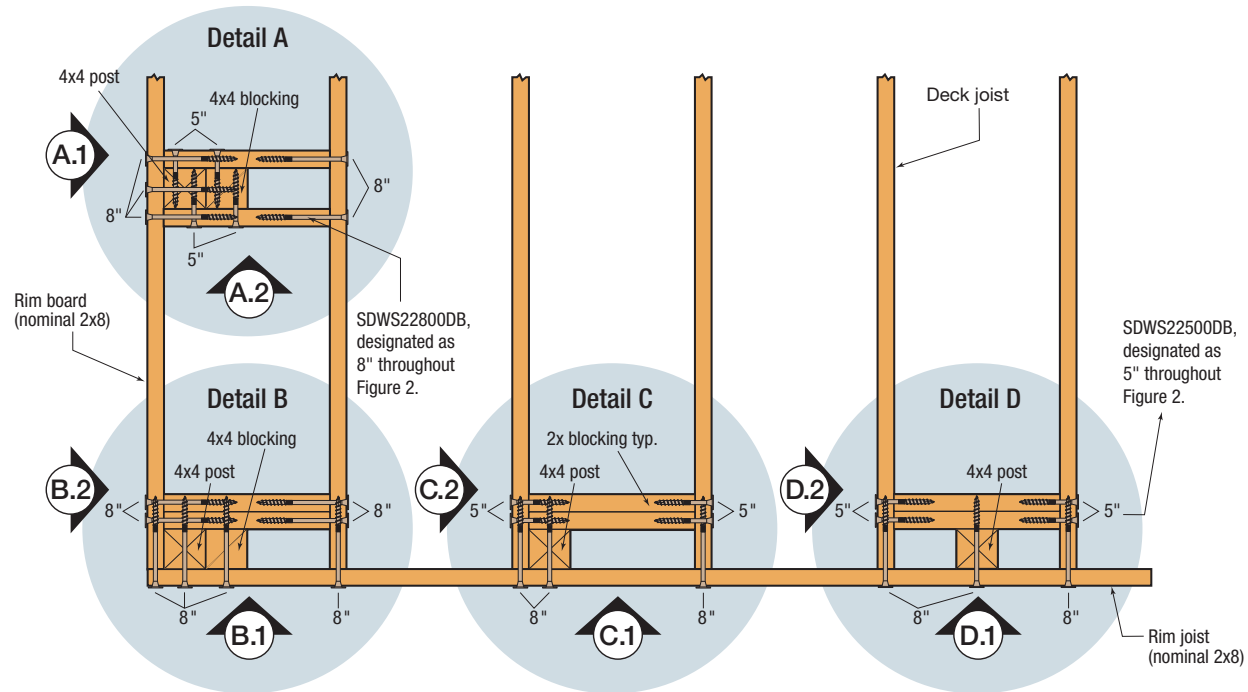

Plan view showing details of four guard post connections using Strong-Drive® SDWS Timber screws

SDWS22DB Screw Information for Guard Post Details

Detail	Model No.	Quantity Required	Length (in.)	Shank Diameter (in.)	Major Diameter (in.)	Minor Diameter (in.)	Thread Length (in.)
A	SDWS22500DB	4	5	0.219	0.305	0.198	2.75
	SDWS22800DB	10	8				
B	SDWS22800DB	16	8				
C	SDWS22500DB	8	5				
	SDWS22800DB	6	8				
D	SDWS22500DB	8	5				
	SDWS22800DB	6	8				

- SDWS Timber screws install best with a low-speed ½" drill and a T-40 6-lobe bit. The matched bit included with the screws is recommended for best results.
- Predrilling is typically not required. Where predrilling is necessary, use a ⅜" drill bit for Strong-Drive SDWS Timber screws.
- Screw heads that are countersunk flush to the wood surface are acceptable if the screw has not spun out.
- Deck joists shall be fastened to rim joist and ledger as required by the code. See p. 303 for rim joist connection.

Load Tables, Technical Data and Installation Instructions

Strong-Drive® SDWS TIMBER Screw for Guard Post Installations (cont.)

Detail A – Interior Post on Rim Board

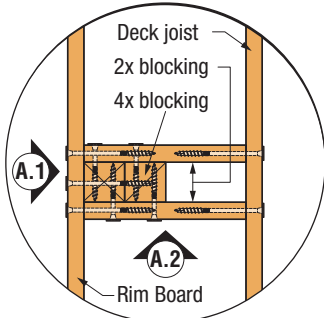

Detail A Plan View

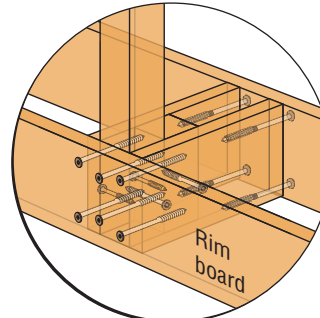

Detail A Isometric View

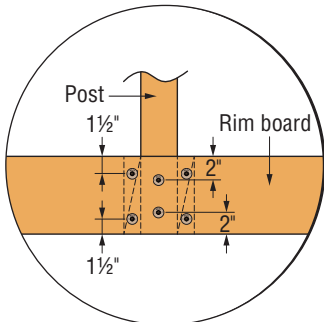

Detail A.1 Front Elevation

1. Rim board to 2x blocking 1 1/2" from top and bottom edges using 8" SDWS22800DB.
2. Rim board to post and 4x blocking 2" from top and bottom edges using 8" SDWS22800DB.

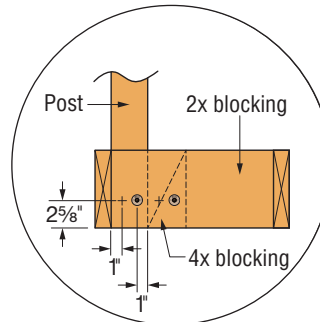

Detail A.2 Side Elevation

1. 2x blocking to post – opposing screws 1" from outer edges of post, 2 5/8" from bottom edge of 2x blocking using 5" SDWS22500DB.
2. 2x blocking to 4x blocking – opposing screws 1" from outer edges of 4x blocking, 2 5/8" from bottom edge of 2x blocking using 5" SDWS22500DB.

Detail B – Interior Post on Corner

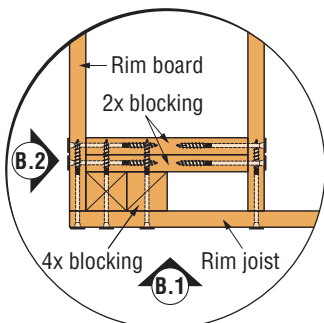

Detail B Plan View

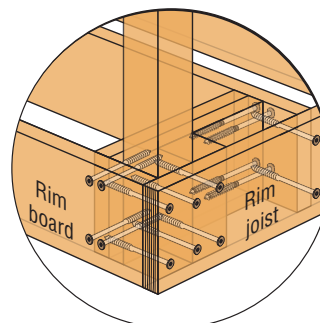

Detail B Isometric View

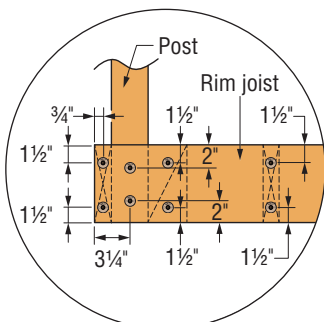

Detail B.1 Front Elevation

Note: For fastening rim joist to rim board and deck joists, predrilling for the SDWS22800DB screws is recommended using a 5/16" drill bit.

1. Rim joist to rim board or deck joists 1 1/2" from top and bottom edges, 3/4" from side edge using 8" SDWS22800DB.
2. Rim joist to post and 2x blocking 2" from top and bottom edges, centered on post using 8" SDWS22800DB.
3. Rim joist to 4x blocking and 2x blocking 1 1/2" from top and bottom edges centered on 4x blocking using 8" SDWS22800DB.

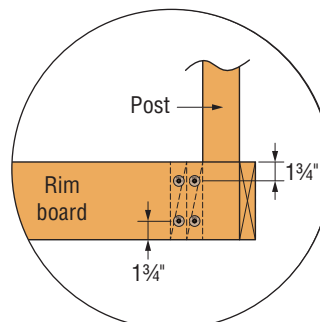

Detail B.2 Side Elevation

1. Rim board to 2x blocking 1 3/4" from top and bottom edges using 8" SDWS22800DB.

Load Tables, Technical Data and Installation Instructions

Strong-Drive® SDWS TIMBER Screw for Guard Post Installations (cont.)

Detail C – Interior Post on Rim Joist with Adjacent Joist

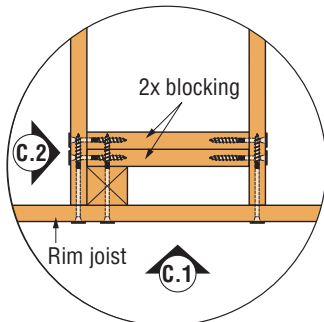

Detail C Plan View

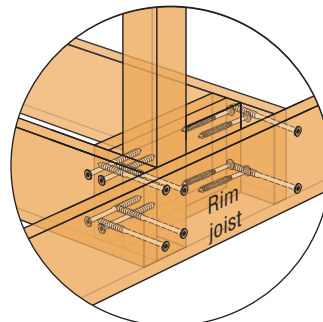

Detail C Isometric View

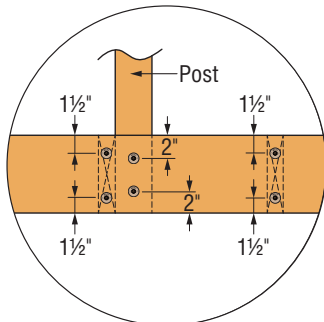

Detail C.1 Front Elevation

1. Rim joist to deck joist 1 1/2" from top and bottom edges using 8" SDWS22800DB.
2. Rim joist to post and 2x blocking 2" from top and bottom edges using 8" SDWS22800DB.

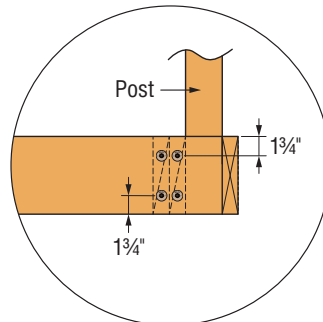

Detail C.2 Side Elevation

1. Deck joist to 2x blocking 1 3/4" from top and bottom edges using 5" SDWS22500DB.

Detail D – Interior Post on Rim Joist Between Joists

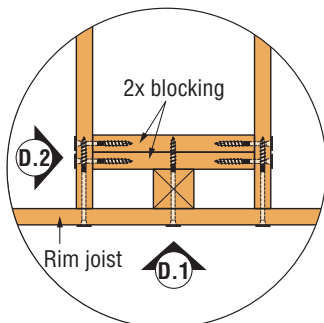

Detail D Plan View

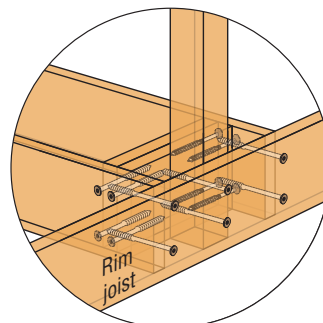

Detail D Isometric View

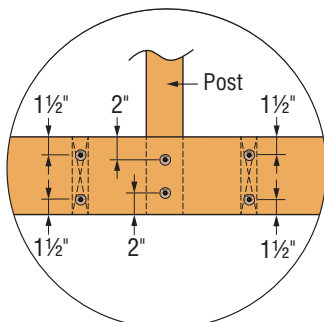

Detail D.1 Front Elevation

1. Rim joist to deck joists 1 1/2" from top and bottom edges using 8" SDWS22800DB.
2. Rim joist to post and 2x blocking 2" from top and bottom edges using 8" SDWS22800DB.

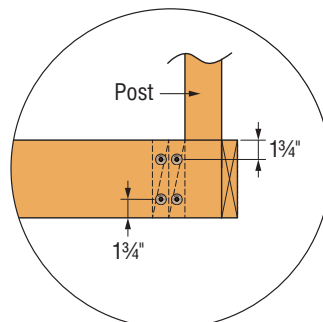

Detail D.2 Side Elevation

1. Deck joist to 2x blocking 1 3/4" from top and bottom edges using 5" SDWS22500DB.

Load Tables, Technical Data and Installation Instructions

Strong-Drive® SDWS TIMBER Screw for Attaching Exterior Foam Insulation

Simpson Strong-Tie® Strong-Drive® SDWS Timber screws may be used for installing exterior rigid-foam board insulation over wood structural panel (WSP) sheathing. Each fastener installs through furring strips, rigid-foam board and WSP sheathing into the wood wall stud framing. The fasteners do not typically require predrilling. Preservative-treated wood suitable for dry-service (AWPA UC1, UC2, UC3A) and untreated wood may be used depending on the protection needs of the construction. The SDWS products with "DB" in the model number have a double-barrier coating that provides corrosion resistance equivalent to hot-dip galvanization, while the products without "DB" in the model number can only be used in conditions with dry-service and no wood treatment chemicals. The table on p. 305 provides recommended spacing for fastening to vertical furring strips through ½" to 6" of rigid foam insulation board into each wall stud. The SDWS22DB and SDWS22 screws were evaluated as alternate threaded fasteners using ICC-ES AC233 and are the subject of IAPMO-UES ER-192. The Strong Drive SDWS22DB Structural Wood screws were evaluated for corrosion resistance using ICC-ES AC257.

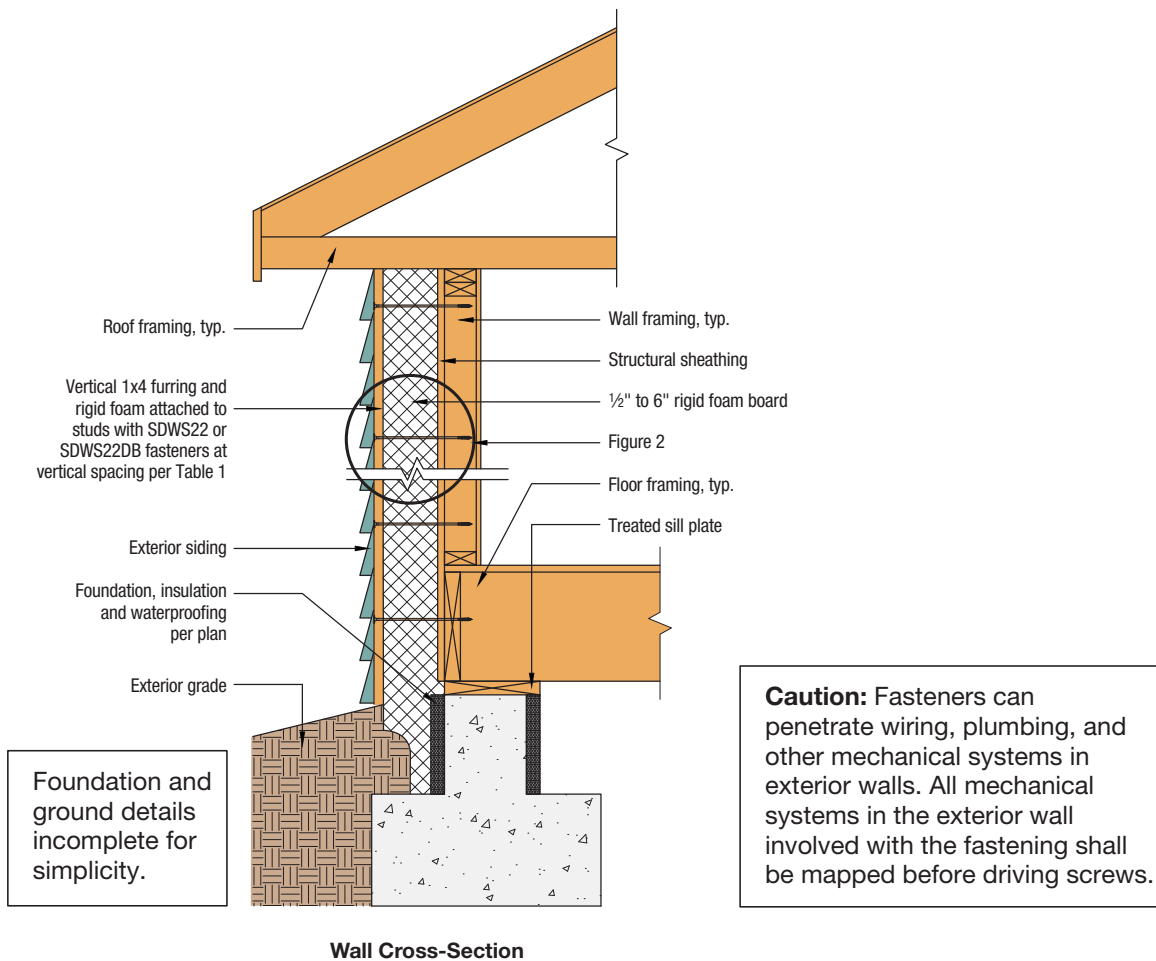

Load Tables, Technical Data and Installation Instructions

Strong-Drive® SDWS TIMBER Screw for Attaching Exterior Foam Insulation (cont.)

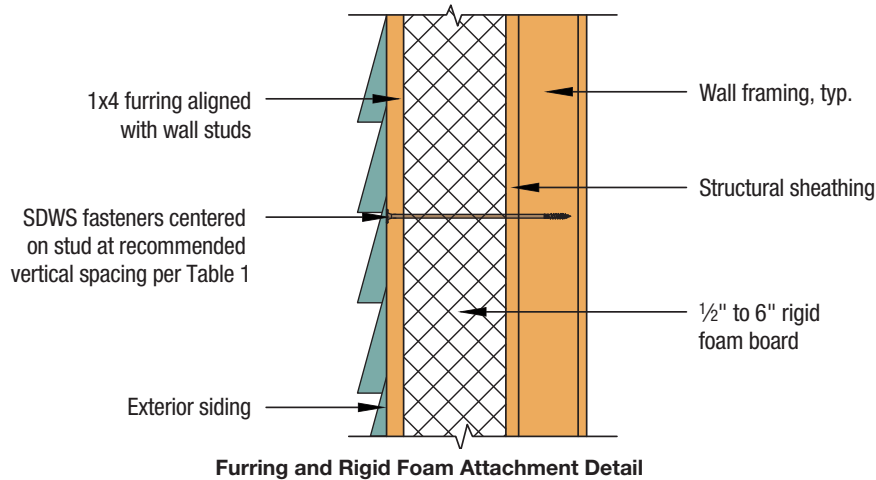

Recommended Vertical Fastener Spacing

Model No.	Size Diameter x L (in.)	Foam Thickness (in.)	Stud Spacing (in.)	Maximum Allowable Cladding Weight to be Supported (psf)		
				≤ 20	25	30
SDWS22400DB	0.220 x 4	½	16	24" o.c.	24" o.c.	24" o.c.
			24			
SDWS22500DB	0.220 x 5	1 to 1¼	16			
			24			
SDWS22600DB	0.220 x 6	1½ to 2	16			
			24			
SDWS22800DB SDWS22800	0.220 x 8	4	16			
			24			
SDWS221000DB SDWS221000	0.220 x 10	6	16	18" o.c.	16" o.c.	
			24			

1. Caution: Fasteners can penetrate wiring, plumbing and other mechanical systems in exterior walls. All mechanical systems in the exterior wall involved with the fastening shall be mapped before driving screws.
2. Foam sheathing shall have a minimum compressive strength of 15 psi in accordance with ASTM C578 or ASTM C1289.
3. Wood wall framing (studs) shall be a minimum of 2" nominal thickness. Wood framing and furring shall be a minimum Spruce-Pine-Fir species with specific gravity of 0.42 or greater. Table assumes furring strip thickness of ¼" and full thread embedment in the framing member.
4. Wood framing, furring and WSP sheathing shall meet the design requirements in accordance with the applicable building codes. WSP sheathing shall be fastened to the framing as required by the applicable building code.
5. Each fastener is capable of resisting 172 lb. of out-of-plane wind loading ($C_D = 1.60$) with no further increase allowed.
6. Spacing recommendations are based on a loading that produced 0.015" of assembly movement with 6" thick rigid foam board insulation.
7. Maximum allowable cladding weight shall be the additive weight of furring, cladding including foam insulation, environmental effects (i.e. ice) and other supported materials.
8. Metal fasteners conduct heat, and it is recommended that exposed screw heads are covered with foam and sealed.
9. Screws shall be installed such that they close gaps between connected components. Furring and sheathing shall provide the required thickness and performance for siding manufacturer installation instructions.

All other information pertaining to the use and installation of Strong-Drive® SDWS22DB and SDWS22 Structural Wood screws is available at strongtie.com.

Load Tables, Technical Data and Installation Instructions

Outdoor Accents® Structural Wood Screw

(Strong-Drive® SDWS TIMBER Screw)

Structural Wood-to-Wood Connections for Outdoor Accents Ornamental Products

Designed to provide an easier and significantly faster installation time compared to through-bolting. The hex-head washer is code report listed (IAPMO-UES ER-192) and is designed exclusively to help fasten Outdoor Accents post bases, T and L straps, and angles.

Black double-barrier (SDWS22DBB) and Quik Guard® (STN22) coating provides corrosion resistance equivalent to hot-dip galvanization (ASTM A153, Class D), making it suitable for certain exterior and preservative-treated wood applications.

Codes/Standards: IAPMO-UES ER-192, State of Florida FL13975

For More Product Information, see p. 73



The SDWS22312DBB and SDWS22512DBB can be used in conjunction with the STN22 hex-head washer. When installing SDWS22312DBB and SDWS22512DBB, the STN22 shall be placed onto wood or steel side plate member prior to screw installation.

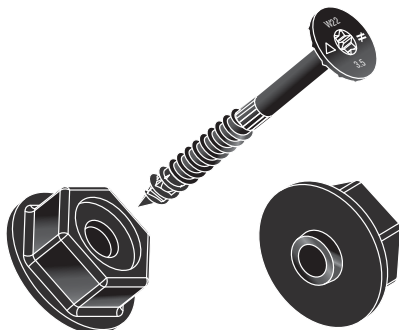

**SDWS22312DBB with
STN22 Hex-Head Washer**

U.S. Patent Pending



SDWS Outdoor Accents Structural Wood Screw with STN22 Hex-Head Washer – Wood to Wood/Steel

Model No.	Thread Length (in.)	Allowable Shear Loads (lb.)					
		2x Wood Side Member			12-ga. Steel Side Member		
		DF/SP	SPF/HF	Western Cedar	DF/SP	SPF/HF	Western Cedar
SDWS22312DBB with STN22	2	235	192	179	470	385	320
SDWS22512DBB with STN22	2 3/4	465	430	395	640	495	425

See footnotes below.

SDWS Outdoor Accents Structural Wood Screw – Wood to Wood

Model No.	Thread Length (in.)	Allowable Shear Loads (lb.)			Allowable Withdrawal Loads (lb./in.)		
		2x Wood Side Member			DF/SP	SPF/HF	Western Cedar
		DF/SP	SPF/HF	Western Cedar			
SDWS22312DBB	2	255	190	225	164	151	142
SDWS22512DBB	2 3/4	405	405	230	214	187	142

1. Allowable loads are for connections between two members with full thread penetration into the main member.
2. Allowable loads are shown at the wood load duration factor of $C_D = 1.0$. Loads may be increased for load duration per the building code up to a $C_D = 1.60$. Tabulated values must be multiplied by all applicable adjustment factors per the NDS.
3. Minimum spacing, edge and end distance requirements are per IAPMO-UES ER-192.
4. Loads are based on installation into the side grain of the wood with the screw axis perpendicular to the face of the member.

Load Tables, Technical Data and Installation Instructions

Outdoor Accents® Connector Screw

(Strong-Drive® SD CONNECTOR Screw)

Structural Wood-to-Wood Connections for Outdoor Accents Ornamental Connectors

The Outdoor Accents® Connector Screw reduces installation time by driving easily without predrilling. Designed for installation with the Outdoor Accents APA21 90-degree angle, the screw's black finish accents any outdoor living project. The sharp point of the screw enables fast starts, and the patented serrated threads reduce torque for improved drivability.

Black double-barrier coating provides corrosion resistance equivalent to hot-dip galvanization (ASTM A153, Class D), making it suitable for certain exterior and preservative-treated wood applications.

Features

- Tested and approved for use in many of our best-selling connectors for both interior and most exterior applications
- The single-fastener steel-side-plate load capacity of the SD10 exceeds the capacity of a 16D common nail
- Ideal for use in tight spaces where using a hammer is inconvenient
- Optimized heat-treating for ductility and strength
- ¼" hex drive included
- Head identification

Codes/Standards: ICC-ES ESR-3046, State of Florida FL 9589

For More Product Information, see p. 74

For more information on Outdoor Accents connector products, please see the *Wood Construction Connectors* catalog, C-C-2017

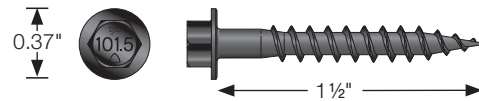

Outdoor Accents Connector Screw

Size (in.)	Model No.	Thread Length (in.)	DF/SP Allowable Loads		SPF/HF Allowable Loads		Code Ref.
			Shear Steel Side Plate 20 ga. – 12 ga. (lb.)	Withdrawal (lb./in.)	Shear Steel Side Plate 20 ga. – 12 ga. (lb.)	Withdrawal (lb./in.)	
#10 x 1½	SD10112DBBR50	1	173	173	138	122	I24

1. Withdrawal loads and steel-side-plate shear loads are based on testing per AC233.
2. Allowable loads are shown at the wood load duration factor of $C_D = 1.00$. Loads may be increased for load duration per the building code up to a $C_D = 1.60$.
3. Withdrawal loads in lb./in. of thread penetration into the side grain of the main member.
4. Visit strongtie.com for wood-to-wood shear values and wood-side-plate details.



Load Tables, Technical Data and Installation Instructions

Strong-Drive® SDWS LOG Screw

Log Home Construction and General Interior Applications

Codes/Standards: IAPMO-UES ER-192, State of Florida FL13975
U.S. Patents: 5,897,280; 7,101,133

For More Product Information, see p. 94

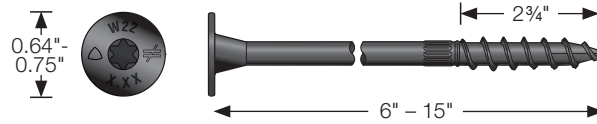

SDWS Log – Allowable Shear Loads Douglas Fir-Larch and Southern Pine

Size (dia. x length) (in.)	Model No.	Thread Length (in.)	DF/SP Allowable Shear Loads (lb.)														
			Wood Side Member Thickness (in.)														
			1.5	2	2.5	3	3.5	4	4.5	5	5.5	6	7	8	9	10	13
0.195 x 6	SDWS19600	2.75	370	265	265	265	265	245	245	—	—	—	—	—	—	—	—
0.195 x 7.5	SDWS19712	2.75	370	265	265	265	265	245	245	245	245	245	—	—	—	—	—
0.220 x 8	SDWS22800	2.75	405	405	405	405	395	395	395	395	395	395	—	—	—	—	—
0.220 x 9	SDWS22900	2.75	405	405	405	405	395	395	395	395	395	395	395	—	—	—	—
0.220 x 10	SDWS221000	2.75	405	405	405	405	395	395	395	395	395	395	395	395	—	—	—
0.220 x 11	SDWS221100	2.75	405	405	405	405	395	395	395	395	395	395	395	395	395	—	—
0.220 x 12	SDWS221200	2.75	405	405	405	405	395	395	395	395	395	395	395	395	395	395	—
0.220 x 15	SDWS221500	2.75	405	405	405	405	395	395	395	395	395	395	395	395	395	395	395

SDWS Log – Allowable Shear Loads Spruce-Pine-Fir and Hem-Fir

Size (dia. x length) (in.)	Model No.	Thread Length (in.)	SPF/HF Allowable Shear Loads (lb.)														
			Wood Side Member Thickness (in.)														
			1.5	2	2.5	3	3.5	4	4.5	5	5.5	6	7	8	9	10	13
0.195 x 6	SDWS19600	2.75	350	265	265	265	265	215	180	—	—	—	—	—	—	—	—
0.195 x 7.5	SDWS19712	2.75	350	265	265	265	265	215	215	215	215	180	—	—	—	—	—
0.220 x 8	SDWS22800	2.75	400	365	365	365	310	310	280	280	280	280	—	—	—	—	—
0.220 x 9	SDWS22900	2.75	400	365	365	365	310	310	280	280	280	280	280	—	—	—	—
0.220 x 10	SDWS221000	2.75	400	365	365	365	310	310	280	280	280	280	280	280	—	—	—
0.220 x 11	SDWS221100	2.75	400	365	365	365	310	310	280	280	280	280	280	280	—	—	—
0.220 x 12	SDWS221200	2.75	400	365	365	365	310	310	280	280	280	280	280	280	280	—	—
0.220 x 15	SDWS221500	2.75	400	365	365	365	310	310	280	280	280	280	280	280	280	280	280

- Design values are based on full fastener embedment and the adjacent members are in contact with each other.
- Allowable loads are shown at the wood load duration factor of $C_D = 1.0$. Loads may be increased for load duration up to a $C_D = 1.6$.
- Tabulated values must be multiplied by all applicable adjustment factors per the NDS.
- Minimum fastener spacing requirements: 6" end distance, 1 $\frac{1}{16}$ " edge distance, $\frac{5}{8}$ " between staggered rows of fasteners, 4" between non-staggered rows of fasteners and 8" between fasteners in a row.
- Loads are for in-service moisture content less than or equal to 19% ($C_M = 1.0$).
- Loads are based on installation into the side grain of the wood member with the screw axis perpendicular to the face of the wood member.

SDWS Log – Allowable Withdrawal Loads Douglas Fir-Larch, Southern Pine, Spruce-Pine-Fir and Hem-Fir Lumber

Size (dia. x length) (in.)	Model No.	Fastener Length (in.)	Thread Length (in.)	Reference Withdrawal Design Value, W (lb./in.)		Maximum Reference Withdrawal Design Value, W_{Max} (lb.)	
				DF and SP Main Member	HF and SPF Main Member	DF and SP Main Member	HF and SPF Main Member
				0.195 x 6	SDWS19600	6	2.75
0.195 x 7.5	SDWS19712	7.5	2.75	197	164	545	395
0.220 x 8	SDWS22800	8	2.75	214	187	590	495
0.220 x 9	SDWS22900	9	2.75	214	187	590	495
0.220 x 10	SDWS221000	10	2.75	214	187	590	495
0.220 x 11	SDWS221100	11	2.75	214	187	590	495
0.220 x 12	SDWS221200	12	2.75	214	187	590	495
0.220 x 15	SDWS221500	15	2.75	214	187	590	495

- The tabulated reference withdrawal design value, W, is in pounds per inch of the thread penetration into the side grain of the main member.
- The tabulated reference withdrawal design value, W_{Max} , is in pounds where the entire thread must penetrate into the side grain of the main member.
- Tabulated reference withdrawal design values ($C_D = 1.0$), W and W_{Max} , must be multiplied by all applicable adjustment factors from the NDS as referenced in the IBC or IRC.
- Embedded thread length is that portion held in the main member including the screw point.
- Values are based on the lesser of withdrawal from the main member or pull-through of a 1.5" side member.
- Loads are for in-service moisture content less than or equal to 19% ($C_M = 1.0$).

Load Tables, Technical Data and Installation Instructions

Strong-Drive® SDWS LOG Screw (cont.)

Allowable Loads for Strong-Drive® SDWS LOG Screws with Expanded Specific Gravity Options

Allowable load tables on the following pages provide shear and withdrawal capacities for wood species with an assigned specific gravity of 0.35 to 0.41. Wood species with a specific gravity within this range are provided below.

Wood Species Combinations in the Specific Gravity Range 0.35 to 0.41

Wood Species	Specific Gravity ¹
Alaska Spruce	0.41
Aspen	0.39
Balsam Fir	0.36
Coast Sitka Spruce	0.39
Cottonwood	0.41
Eastern Hemlock	0.41
Eastern Hemlock-Balsam Fir	0.36
Eastern Hemlock-Tamarack	0.41
Eastern Softwoods	0.36
Eastern Spruce	0.41
Eastern White Pine	0.36
Engelmann Spruce-Lodgepole Pine	0.38
Northern Species	0.35
Redwood, open grain	0.37
Spruce-Pine-Fir (South)	0.36
Western Cedars	0.36
Western Cedars (North)	0.35
Western White Pine	0.40
Western Woods	0.36

1. Specific gravity as assigned in NDS-2012 Table 11.3.3A.

Load Tables, Technical Data and Installation Instructions

Strong-Drive® SDWS LOG Screw (cont.)

SDWS Log – Allowable Lateral Loads in the Specific Gravity Range 0.35 to 0.41

Size (dia. x length) (in.)	Model No.	Thread Length (in.)	Reference Allowable Lateral Design Value (lb.)													
			Wood Side Member Thickness (in.)													
			1.5	2	2.5	3	3.5	4	5	5.5	6	7	8	9	10	13
0.195 x 6	SDWS19600	2.75	330	230	230	230	230	230	230	—	—	—	—	—	—	—
0.195 x 7.5	SDWS19712	2.75	330	230	230	230	230	230	230	230	—	—	—	—	—	—
0.220 x 8	SDWS22800	2.75	350	240	240	240	240	240	240	240	240	—	—	—	—	—
0.220 x 9	SDWS22900	2.75	350	240	240	240	240	240	240	240	240	240	—	—	—	—
0.220 x 10	SDWS221000	2.75	350	240	240	240	240	240	240	240	240	240	240	—	—	—
0.220 x 11	SDWS221100	2.75	350	240	240	240	240	240	240	240	240	240	240	240	—	—
0.220 x 12	SDWS221200	2.75	350	240	240	240	240	240	240	240	240	240	240	240	240	—
0.220 x 15	SDWS221500	2.75	350	240	240	240	240	240	240	240	240	240	240	240	240	240

- Design values are based on full fastener embedment and the adjacent members are in contact with each other.
- Allowable loads are shown at the wood load duration factor of $C_D = 1.0$. Loads may be increased for load duration per the building code up to a $C_D = 1.6$. Tabulated values must be multiplied by all applicable adjustment factors per the NDS.
- Minimum fastener spacing requirements: 6" end distance, 1 $\frac{1}{16}$ " edge distance, $\frac{5}{8}$ " between staggered rows of fasteners, 4" between non-staggered rows of fasteners and 8" between fasteners in a row.
- For in-service moisture content less than or equal to 19% ($C_M = 1.0$).
- The load tables are based on testing in accordance with ICC-ES AC233, with an applied factor of safety of 5.0.

SDWS Log – Allowable Withdrawal Loads in the Specific Gravity Range 0.35 to 0.41

Size (dia. x length) (in.)	Model No.	Thread Length (in.)	Reference Withdrawal Design Value, W (lb./in.)	Maximum Reference Withdrawal Design Value, W_{Max} (lb.) ⁵
0.195 x 6	SDWS19600	2.75	100	280
0.195 x 7.5	SDWS19712	2.75	100	280
0.220 x 8	SDWS22800	2.75	130	360
0.220 x 9	SDWS22900	2.75	130	360
0.220 x 10	SDWS221000	2.75	130	360
0.220 x 11	SDWS221100	2.75	130	360
0.220 x 12	SDWS221200	2.75	130	360
0.220 x 15	SDWS221500	2.75	130	360

- The tabulated reference withdrawal design value, W, is in pounds per inch of the thread penetration into the side grain of the main member.
- The tabulated reference withdrawal design value, W_{Max} , is in pounds where the entire thread must penetrate into the side grain of the main member.
- Tabulated reference withdrawal design values, W and W_{Max} , are shown at the wood load duration factor of $C_D = 1.0$. Loads may be increased for load duration per the building code up to a $C_D = 1.6$. Tabulated values must be multiplied by all applicable adjustment factors per the NDS as referenced in the IBC or IRC.
- Embedded thread length is that portion held in the main member including the screw point.
- Values are based on the lesser of withdrawal from the main member or pull-through of a 1.5" side member.
- For in-service moisture content less than or equal to 19% ($C_M = 1.0$).
- The load tables are based on testing in accordance with ICC-ES AC233, with an applied factor of safety of 5.0.

Load Tables, Technical Data and Installation Instructions

Strong-Drive® SDWH TIMBER-HEX Screw

Structural Wood-to-Wood Connections, Including Ledgers

Double-barrier coating provides corrosion resistance equivalent to hot-dip galvanization, making it suitable for certain exterior and preservative-treated wood applications, as described in the evaluation report.

Codes/Standards: IAPMO-UES ER-192, State of Florida FL13975

U.S. Patents 5,897,280; 7,101,133

For More Product Information, see p. 70

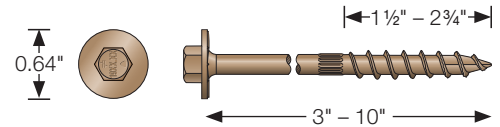

SDWH – Allowable Shear Loads – Douglas Fir-Larch and Southern Pine Lumber

Size (dia. x length) (in.)	Model No.	Thread Length (in.)	DF/SP Allowable Shear Loads (lb.)									
			Wood Side Member Thickness (in.)									
			1.5	2	2.5	3	3.5	4	4.5	6	8	
0.195 x 3	SDWH19300DB	1½	285	—	—	—	—	—	—	—	—	—
0.195 x 4	SDWH19400DB	2¾	370	300	300	—	—	—	—	—	—	—
0.195 x 6	SDWH19600DB	2¾	370	265	265	265	265	245	245	—	—	—
0.195 x 8	SDWH19800DB	2¾	370	265	265	265	265	265	260	245	—	—
0.195 x 10	SDWH191000DB	2¾	370	265	265	265	265	265	260	260	245	—

See footnotes below.

SDWH – Allowable Shear Loads – Spruce-Pine-Fir and Hem-Fir Lumber

Size (dia. x length) (in.)	Model No.	Thread Length (in.)	SPF/HF Allowable Shear Loads (lb.)									
			Wood Side Member Thickness (in.)									
			1.5	2	2.5	3	3.5	4	4.5	6	8	
0.195 x 3	SDWH19300DB	1½	230	—	—	—	—	—	—	—	—	—
0.195 x 4	SDWH19400DB	2¾	330	235	195	—	—	—	—	—	—	—
0.195 x 6	SDWH19600DB	2¾	350	265	265	265	265	215	180	—	—	—
0.195 x 8	SDWH19800DB	2¾	350	265	265	265	265	265	215	215	—	—
0.195 x 10	SDWH191000DB	2¾	350	265	265	265	265	265	250	250	215	—

- All applications are based on full penetration into the main member. Full penetration is the screw length minus the side member thickness.
- Allowable loads are shown at the wood load duration factor of $C_D = 1.0$. Loads may be increased for load duration per the building code up to a $C_D = 1.6$. Tabulated values must be multiplied by all applicable adjustment factors per the NDS.
- Minimum fastener spacing requirements to achieve table loads: 6" end distance, 1½" edge distance, 5/8" between staggered rows of fasteners, 4" between non-staggered rows of fasteners and 8" between fasteners in a row.
- For in-service moisture content greater than 19%, use $C_M = 0.7$.
- Loads are based on installation into the side grain of the wood with the screw axis perpendicular to the face of the member.

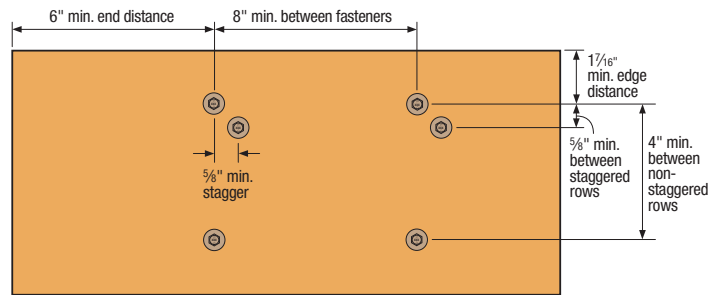

SDWH Spacing Requirements

SDWH – Allowable Withdrawal Loads – Douglas Fir-Larch, Southern Pine, Spruce-Pine-Fir and Hem-Fir Lumber

Size (dia. x length) (in.)	Model No.	Fastener Length (in.)	Thread Length (in.)	Reference Withdrawal Design Value, W (lb./in.)		Max. Reference Withdrawal Design Value, W_{Max} (lb.)	
				DF and SP Main Member	HF and SPF Main Member	DF and SP Main Member	HF and SPF Main Member
				0.195 x 3	SDWH19300DB	3	177
0.195 x 4	SDWH19400DB	4	192	147	455	350	
0.195 x 6	SDWH19600DB	6	197	164	545	445	
0.195 x 8	SDWH19800DB	8	197	164	545	445	
0.195 x 10	SDWH191000DB	10	197	164	545	445	

- The tabulated reference withdrawal design value, W, is in pounds per inch of the thread penetration into the side grain of the main member.
- The tabulated reference withdrawal design value, W_{Max} , is in pounds where the entire thread length must penetrate into the side grain of the main member.
- Tabulated reference withdrawal design values, W and W_{Max} , are shown at a $C_D = 1.0$. Loads may be increased for load duration per the building code up to a $C_D = 1.6$. Tabulated values must be multiplied by all applicable adjustment factors from the NDS as referenced in the IBC or IRC.
- Embedded thread length is that portion held in the main member including the screw point.
- Values are based on the lesser of withdrawal from the main member or pull-through of a 1½" side member.
- For in-service moisture content greater than 19%, use $C_M = 0.7$.

Load Tables, Technical Data and Installation Instructions

Strong-Drive® SDWH TIMBER-HEX Screw (cont.)

SDWH – 2012 and 2015 IRC Compliant Spacing for
a Sawn Lumber Deck Ledger to Rim Board

Loading Condition	Nominal Ledger Size	Model No.	Rim Board Material and Minimum Size	Maximum Deck Joist Span						
				Up to 6 ft.	Up to 8 ft.	Up to 10 ft.	Up to 12 ft.	Up to 14 ft.	Up to 16 ft.	Up to 18 ft.
				Maximum On-Center Spacing of Fasteners (in.)						
40 psf Live 10 psf Dead	2x	SDWH19400DB	1" OSB	13	9	8	6	5	5	4
			1" LVL							
			1 1/8" OSB	18	13	11	9	8	7	6
			1 5/16" LVL							
			1 1/4" LSL							
2x SP, DFL – 2x SPF, HF	15	12	9	8	7	6	5			
60 psf Live 10 psf Dead	2x	SDWH19400DB	1" OSB	9	7	5	5	4	—	—
			1" LVL							
			1 1/8" OSB	13	10	8	6	5	5	4
			1 5/16" LVL							
			1 1/4" LSL							
			2x SP, DFL – 2x SPF, HF	11	8	7	6	5	4	4

- SDWH screw spacing values are equivalent to 2012/2015 IRC table R507.2. The table above also provides SDWH screw spacing for a wider range of materials commonly used for rim board, and an alternate loading condition as required by some jurisdictions.
- Solid-sawn rim board shall be Spruce-Pine-Fir, Hem-Fir, Douglas Fir-Larch, or Southern Pine species. Ledger shall be Hem-Fir, Douglas Fir-Larch, or Southern Pine species.
- Fastener spacings are based on the lesser of single fastener ICC-ES AC233 testing of the Strong-Drive® SDWH screw with a safety factor of 5.0 or ICC-ES AC13 assembly testing with a factor of safety of 5.0. Spacing includes NDS wet service factor adjustment.
- Rows of screws shall be vertically offset and evenly staggered. Screws shall be placed 1 1/2" to 2" from the top and bottom of the ledger or rim board with 3" minimum and 6" maximum between rows and spaced per the table. End screws shall be located 6" from the end and at 1 1/2" to 2" from the bottom of the ledger. For screws located at least 2" but less than 6" from the end, use 50% of the load per screw and 50% of the table spacing between the end screw and the adjacent screw, and for screws located between 2" and 4" from the end, predrill using a 1.8" drill.
- Structural sheathing between the ledger and rim board shall be a maximum of 1/2" thick and fastened per code.

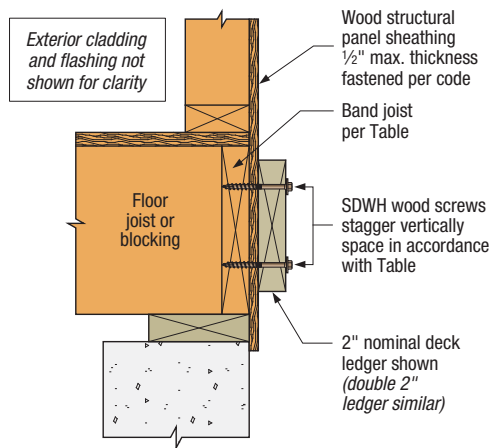

Ledger-to-Rim Board Assembly

(Wood-framed lower floor acceptable, concrete wall shown for illustration purposes)

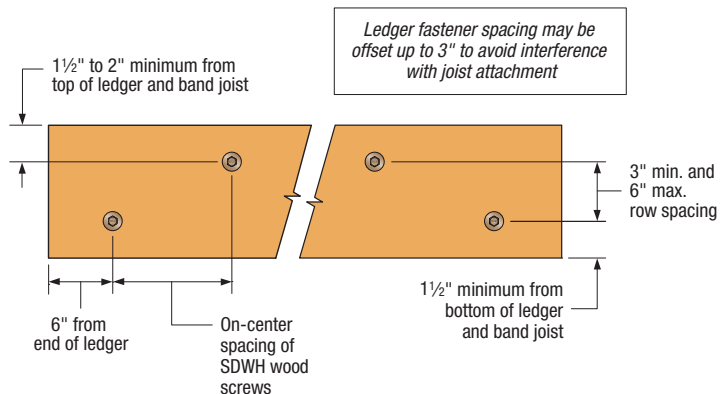

SDWH Screw Spacing Detail

Load Tables, Technical Data and Installation Instructions

Strong-Drive®

SDWH TIMBER-HEX Screw (cont.)

SDWH – Allowable Shear Loads for Sole-to-Rim Connections

Size (in.)	Model No.	Nominal Sole Plate Thickness (in.)	Minimum Penetration into Rim Board (in.)	Allowable Loads (lb.)							
				2x DF/SP Rim Board		2x SPF/HF Rim Board		1 1/4" Min. LVL Rim Board		1 1/4" Min. LSL Rim Board	
				DF/SP Sole Plate	SPF/HF Sole Plate	DF/SP Sole Plate	SPF/HF Sole Plate	DF/SP Sole Plate	SPF/HF Sole Plate	DF/SP Sole Plate	SPF/HF Sole Plate
0.195 x 4	SDWH19400DB	2x	1.75	315	295	295	295	255	255	275	275
0.195 x 6	SDWH19600DB	2x or 3x	2	315	295	295	295	255	255	275	275

1. Allowable loads are based on testing per ICC-ES AC233 and are limited to parallel-to-grain loading.
2. Allowable loads are shown at the wood load duration factor of $C_D = 1.00$. Loads may be increased for load duration by the building code up to a $C_D = 1.60$.
3. Minimum spacing of the SDWH is 6" o.c., minimum end distance is 6", and minimum edge distance is 5/8".
4. Wood structural panel up to 1 1/8" thick is permitted between the sole plate and rim board provided it is fastened to the rim board per code and the minimum penetration of the screw into the rim board is met.
5. A double 2x sole plate is permitted provided it is independently fastened per the code and the minimum screw penetration per the table is met.

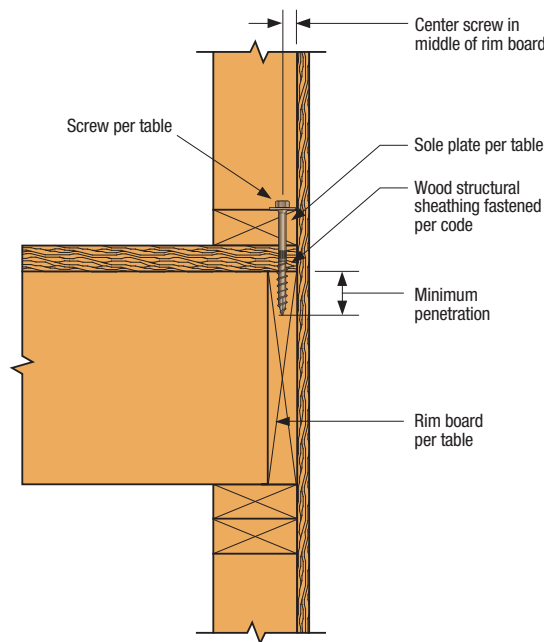

Sole-to-Rim Board Assembly

Load Tables, Technical Data and Installation Instructions

Strong-Drive®

SDWH TIMBER-HEX and SDWS TIMBER Screw

2012/2015 IRC Compliant Spacing and Allowable Shear Loads for Fastening a Sawn Lumber Deck Ledger to Rim Board with ½" Gap

Strong-Drive® SDWS Timber screws and SDWH Timber-Hex screws are suitable for installing ledgers with up to ½" drainage gap between the ledger and the rim board. These fasteners do not require predrilling and have a double barrier coating providing corrosion resistance equivalent to hot-dip galvanization. The gap is formed by stacking hot-dipped galvanized or stainless steel ¼" Type A plain washers (0.625" outside diameter, 0.281" inside diameter) on the shank of the screws between the ledger and the rim board. Weather proofing shall be the responsibility of the installer. The table below lists the maximum on-center spacing of SDWS Timber screws and SDWH Timber-Hex screws when attaching a 2x ledger to the listed rim board of various widths with a maximum ½" gap between them.

Loading Condition: 40 PSF Live Load and 10 PSF Dead Load

Ledger Nominal Size (in.)	Rim Board Material (in.)	Model No.	Maximum Deck Joist Span						
			Up to 6 ft.	Up to 8 ft.	Up to 10 ft.	Up to 12 ft.	Up to 14 ft.	Up to 16 ft.	Up to 18 ft.
			Maximum On-Center Spacing of Fasteners (in.)						
2x	2x DFL, SP, SPF #2	SDWS22400DB	15	11	9	7	6	5	5
		SDWH19400DB	14	11	8	7	6	5	4
	1.125" LSL	SDWS22400DB	14	10	8	7	6	5	4
		SDWH19400DB	13	10	8	6	5	5	4
	1.75" LVL	SDWS22400DB	16	12	9	8	7	6	5
		SDWH19400DB	14	10	8	7	6	5	4

- Solid sawn ledger shall be Spruce-Pine-Fir or Hem-Fir (SG = 0.42) or better. Rim board is to be dry lumber (specific gravity at least 0.42) or EWP rim board product (equivalent specific gravity of at least 0.42 for nails and screws installed in the face orientation).
- Fastener spacings are based on the lesser of single fastener testing following ICC-ES AC233 or ledger assembly testing following ICC-ES AC13 using a safety factor of 5.0. Spacing includes NDS wet service factor adjustment.
- Screws shall be placed at least 2" from the top and 1 ½" from the bottom of the ledger or rim board, 6" from the end of the ledger with 3" between rows (minimum) and 6" between rows (maximum) and spaced per the table. End screws shall be located near the bottom of the ledger. See figure.
- Wood structural panel sheathing between the ledger and rim board shall be a maximum of ½" thick and fastened per code.
- Screws shall be tightened such that the washer stacks are tightly compressed between the ledger and the rim board.
- Maximum ½" gap formed by stacked hot-dipped galvanized or stainless steel ¼" Type A plain washers with a nominal outside diameter of 0.625" and inside diameter of 0.281".
- The fastener specifications in this table meet the prescriptive deck ledger attachment solutions and loading requirements per Table R507.2 of the 2012 and 2015 IRC.

Load Tables, Technical Data and Installation Instructions

Strong-Drive® SDWH TIMBER-HEX and SDWS TIMBER Screw (cont.)

2012/2015 IRC Compliant Spacing and Allowable Shear Loads
for Fastening a Sawn Lumber Deck Ledger to Rim Board with ½" Gap

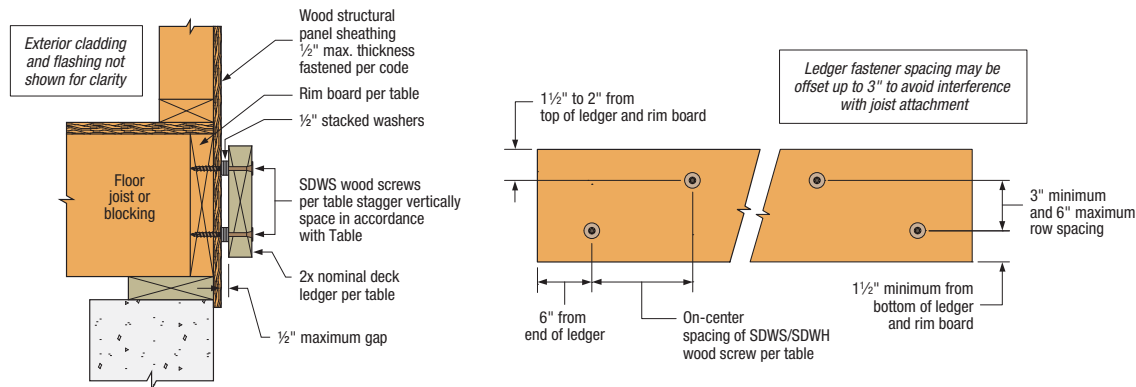

Table below lists the allowable shear loads for SDWS Timber Screws and SDWH Timber-Hex Screws when attaching a 2x ledger with up to ½" thickness of stacked washers to the listed rim board.

Single-Fastener Allowable Shear Loads for Fastening a Sawn Lumber Deck Ledger to Rim Board with ½" Gap

Nominal Ledger Size (in.)	Rim Board	Model No.	Allowable Load (lb.)
2x	2x SPF, DF, SP #2	SDWS22400DB	270
		SDWH19400DB	260
	1 ½" LSL	SDWS22400DB	255
		SDWH19400DB	245
	1 ¾" LVL	SDWS22400DB	290
		SDWH19400DB	255

- Solid Sawn 2x nominal ledger shall be Spruce-Pine-Fir or Hem-Fir (SG = 0.42) or better.
- Band joist is to be dry lumber (specific gravity at least 0.42) or EWP rim board product (equivalent specific gravity of at least 0.42 for nails and screws installed in the face orientation).
- Fastener spacings are based on the lesser of single fastener testing following ICC-ES AC233 or ledger assembly testing following ICC-ES AC13 using a safety factor of 5.0.
- Screws shall be placed at least 2" from the top and 1 ½" from the bottom of the ledger or rim board, 6" from the end of the ledger with 3" between rows (minimum) and 6" between rows (maximum) and have a minimum on-center spacing of 4".
- Wood structural panel sheathing between the ledger and rim board shall be a maximum of ½" thick and fastened per code.
- Screws shall be tightened such that the washer stack is tightly compressed between the ledger and the rim board.
- Maximum ½" gap composed of stacked hot-dipped galvanized or stainless steel ¼" Type A plain washers with an outside diameter equal to 0.625" and inside diameter equal to 0.281".
- Allowable loads are shown at the wood load duration factor of $C_D = 1.0$. Loads may be increased for load duration per the building code up to a $C_D = 1.6$. Tabulated values must be multiplied by all applicable adjustment factors per the NDS, including wet service factor.

Load Tables, Technical Data and Installation Instructions

Strong-Drive® SDWH TIMBER-HEX Screw in Ledger-to-Stud Applications

Strong-Drive® SDWH Timber-Hex screws may be used to attach a ledger to the narrow face of nominal 2x lumber studs according to the following table. Tests and analyses were performed in accordance with ICC-ES Acceptance Criteria AC233.

SDWH Timber-Hex Screw – Allowable Shear Loads for Ledger Attachment to Studs

Model No.	Length (in.)	Nominal Ledger Size (in.)	Number of Screws per Stud	Allowable Shear Load (lb.)		
				DF	SPF/HF	SP
SDWH19400DB	4	2x6	2	630	540	630
		2x8	3	815	815	630
		2x10	4	1,170	975	—

- Allowable loads shall be limited to parallel-to-grain loaded solid sawn main members (minimum 2" nominal). Wood side members shall be loaded perpendicular to grain.
- Allowable loads are based on DF, SPF/HF, and SP wood members having a minimum specific gravity of 0.50, 0.42, and 0.55, respectively. Where the side and main members have different specific gravities, the lower values shall be used.
- Allowable loads are shown at the wood load duration factor of $C_D = 1.00$. Loads may be increased for load duration as permitted by the building code up to a $C_D = 1.60$. All adjustment factors shall be applied per the NDS-2012. For in-service moisture content greater than 19%, use $C_M = 0.70$.
- Fasteners shall be centered in the stud and spaced as shown in the figure. The stud minimum end distance is 6" when loaded toward the end and 2½" when loaded away from the end. The ledger end distance is 6" for full values. For ledger end distanced between 2" and 6" use 50% of the table loads. For end distances between 2" and 4", predrill using a ⅛" bit for the SDWH.
- Screws may be installed with an intermediate layer of wood structural panel between the side and main member provided the wood structural panel is fastened to the main member per code and the minimum screw penetration of 2½" into the main member (excluding the wood structural panel) is met. Longer lengths of the screw series may be used.
- For LRFD values, the reference connection design values shall be adjusted in accordance with the NDS-2012, section 10.3.
- For 2x10 SP ledgers, use the number of screws and allowable loads of the 2x8 SP ledger.
- For 2x8 ledgers with two screws, use 2x6 values. For 2x10 ledgers with three screws, use 2x8 values. Spacings and edge distances shown in the figure are minimum dimensions.
- For loads in the opposite direction from that shown in the figure, use the table values multiplied by: 0.50 for two screw connections, 0.67 for three screw connections, and 0.75 for four screw connections.

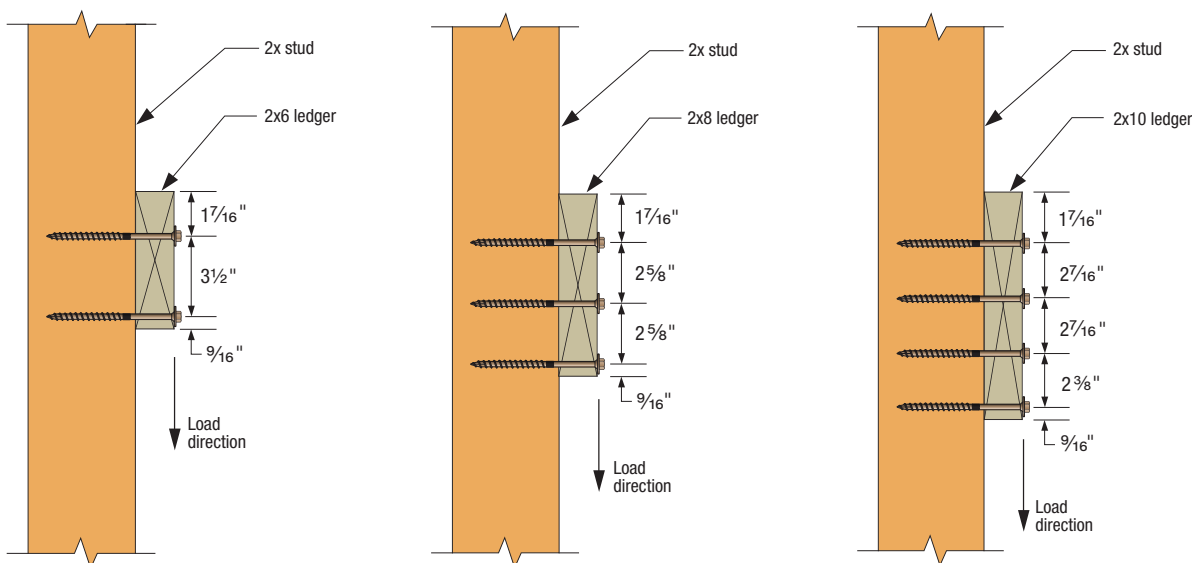

Load Tables, Technical Data and Installation Instructions

Strong-Drive® SDWH TIMBER-HEX Screw with Gypsum Board Interlayer(s)

The Strong-Drive® SDWH Timber-Hex screw may be installed with one or two layers of 5/8" gypsum board between the wood ledger and the main member. See table for the required screw lengths and allowable loads for these applications. Loads are derived from assembly testing based on ICC-ES AC233.

SDWH Timber-Hex Screw – Douglas Fir-Larch and Southern Pine Lumber Allowable Single Shear Loads with One Layer of 5/8" Gypsum Board

Size (in.)	Model No.	Thread Length (in.)	DF/SP Allowable Shear Loads (lb.)								
			Wood Side Member Thickness (in.)								
			1.5	2.0	2.5	3.0	3.5	4.0	4.5	6.0	8.0
0.19 x 4	SDWH19400DB	2.375	240	—	—	—	—	—	—	—	—
0.19 x 6	SDWH19600DB	2.75	240	170	170	170	170	—	—	—	—
0.19 x 8	SDWH19800DB	2.75	240	170	170	170	170	170	170	—	—
0.19 x 10	SDWH191000DB	2.75	240	170	170	170	170	170	170	170	—

See notes on following page.

SDWH Timber-Hex Screw – Douglas Fir-Larch and Southern Pine Lumber Allowable Single Shear Loads with Two Layers of 5/8" Gypsum Board

Size (in.)	Model No.	Thread Length (in.)	DF/SP Allowable Shear Loads (lb.)								
			Wood Side Member Thickness (in.)								
			1.5	2.0	2.5	3.0	3.5	4.0	4.5	6.0	8.0
0.19 x 4	SDWH19400DB	2.375	—	—	—	—	—	—	—	—	—
0.19 x 6	SDWH19600DB	2.75	240	170	170	170	—	—	—	—	—
0.19 x 8	SDWH19800DB	2.75	240	170	170	170	170	170	170	—	—
0.19 x 10	SDWH191000DB	2.75	240	170	170	170	170	170	170	170	—

See notes on following page.

SDWH Timber-Hex Screw – Spruce-Pine-Fir and Hem-Fir Lumber Allowable Single Shear Loads with One Layer of 5/8" Gypsum Board

Size (in.)	Model No.	Thread Length (in.)	SPF/HF Allowable Shear Loads (lb.)								
			Wood Side Member Thickness (in.)								
			1.5	2.0	2.5	3.0	3.5	4.0	4.5	6.0	8.0
0.19 x 4	SDWH19400DB	2.375	215	—	—	—	—	—	—	—	—
0.19 x 6	SDWH19600DB	2.75	230	170	170	170	170	—	—	—	—
0.19 x 8	SDWH19800DB	2.75	230	170	170	170	170	170	140	—	—
0.19 x 10	SDWH191000DB	2.75	230	170	170	170	170	170	165	165	—

See notes on following page.

Load Tables, Technical Data and Installation Instructions

Strong-Drive® SDWH **TIMBER-HEX** Screw with Gypsum Board Interlayer(s) (cont.)

SDWH Timber-Hex Screw – Spruce-Pine-Fir and Hem-Fir Lumber
Allowable Single Shear Loads with Two Layers of 5/8" Gypsum Board

Size (in.)	Model No.	Thread Length	SPF/HF Allowable Shear Loads (lb.)									
			Wood Side Member Thickness (in.)									
			1.5	2.0	2.5	3.0	3.5	4.0	4.5	6.0	8.0	
0.19 x 4	SDWH19400DB	2.375	215	—	—	—	—	—	—	—	—	—
0.19 x 6	SDWH19600DB	2.75	230	170	170	170	—	—	—	—	—	—
0.19 x 8	SDWH19800DB	2.75	230	170	170	170	170	170	140	—	—	—
0.19 x 10	SDWH191000DB	2.75	230	170	170	170	170	170	165	165	—	—

1. All applications are based on full penetration which equals fastener length minus member thickness.
2. Allowable loads are shown at the wood load duration factor of $C_D = 1.0$. Loads may be increase for load duration per the building code up to a $C_D = 1.6$. Tabulated values must be multiplied by all applicable adjustment factors per the NDS.
3. Minimum fastener spacing requirements: 6" end distance, 1 7/16" edge distance, 5/8" between staggered rows of fasteners, 4" between non-staggered rows of fasteners and 8" between fasteners in a row. See figure below.
4. For in-service moisture content greater than 19% use $C_M = 0.7$.
5. Gypsum board must be attached as required per the building code.

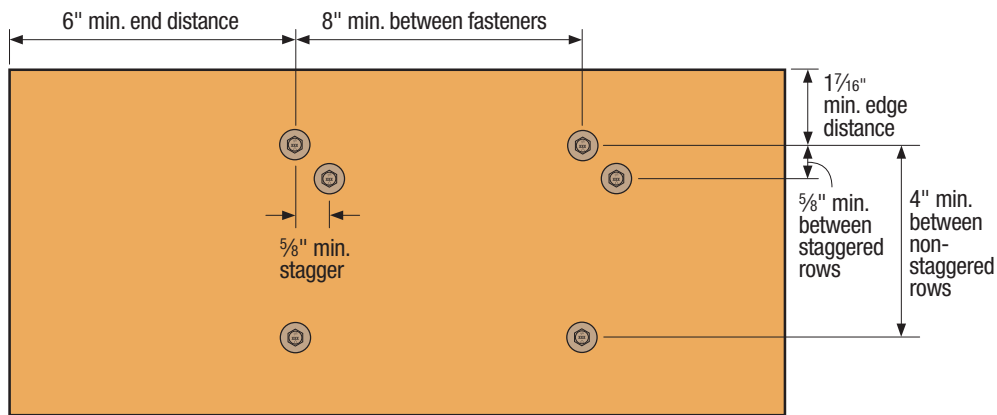

Spacing Requirements

Load Tables, Technical Data and Installation Instructions

Strong-Drive® SDWH TIMBER-HEX Screw with Gypsum Board Interlayer(s) (cont.)

SDWH Timber-Hex Screw – 2012 and 2015 IRC Compliant Spacing for a Sawn Lumber Ledger to Rim Board with One or Two Layers of 5/8" Gypsum Board

Loading Condition	Nominal Ledger Thickness (in.)	Model No.	Rim Board Material and Minimum Size	Maximum Deck Joist Span						
				Up to 6 ft.	Up to 8 ft.	Up to 10 ft.	Up to 12 ft.	Up to 14 ft.	Up to 16 ft.	Up to 18 ft.
				Maximum On-Center Spacing of Fasteners (in.)						
40 psf Live 10 psf Dead	2x	For one layer of gypsum board use: SDWH19400DB For two layers of gypsum board use: SDWH19600DB	1" OSB 1" LVL	12	9	7	6	5	4	4
			1 1/8" OSB 1 5/16" LVL 1 1/4" LSL	17	12	10	8	7	6	6
			2x SP, DF 2x SPF, HF	14	11	9	7	6	5	5
60 psf Live 10 psf Dead	2x	For one layer of gypsum board use: SDWH19400DB For two layers of gypsum board use: SDWH19600DB	1" OSB 1" LVL	8	6	5	4	4	—	—
			1 1/8" OSB 1 5/16" LVL 1 1/4" LSL	12	9	7	6	5	4	4
			2x SP, DF 2x SPF, HF	10	8	6	5	4	4	—
100 psf Live 10 psf Dead	2x	For one layer of gypsum board use: SDWH19400DB For two layers of gypsum board use: SDWH19600DB	1" OSB 1" LVL	5	4	—	—	—	—	—
			1 1/8" OSB 1 5/16" LV 1 1/4" LSL	8	6	5	4	—	—	—
			2x SP, DF 2x SPF, HF	7	5	4	—	—	—	—

- Solid-sawn rim board shall be Spruce-Pine-Fir, Hem-Fir, Douglas Fir-Larch, or Southern Pine species. Ledger shall be Hem-Fir, Douglas Fir-Larch, or Southern Pine species.
- Fastener spacings are based on the lesser of single fastener ICC-ES AC233 testing of the Strong-Drive® SDWH screw with a safety factor of 5.0 or ledger assembly testing based on ICC-ES AC13 with a factor of safety of 3.0. Spacing does NOT include NDS wet service factor adjustment.
- Multiple ledger plies shall be fastened together per code independent of the SDWH screws.
- SDWH screw spacing values are equivalent to 2012/2015 IRC Table R507.2. The tables also provides SDWH screw spacing for a wider range of materials commonly used for rim board, and an alternate loading condition as required by some jurisdictions.
- Rows of screws shall be vertically offset and evenly staggered. Screws shall be placed 1 1/2" to 2" from the top and bottom of the ledger or rim board with 3" minimum and 6" maximum between rows and spaced per the table. End screws shall be located 6" from the end and at 1 1/2" to 2" from the bottom of the ledger. For screws located at least 2" but less than 6" from the end, use 50% of the load per screw and 50% of the table spacing between the end screw and the adjacent screw, and for screws located between 2" and 4" from the end, predrill using a 1/8" drill.
- The design installation permits a wood structural panel (WSP) interlayer in addition to one or two layers of gypsum board. If present, the WSP shall be a maximum of 1/2" thick, adjacent to the framing and fastened directly to the framing per the code.
- Gypsum board must be attached as required per the building code.

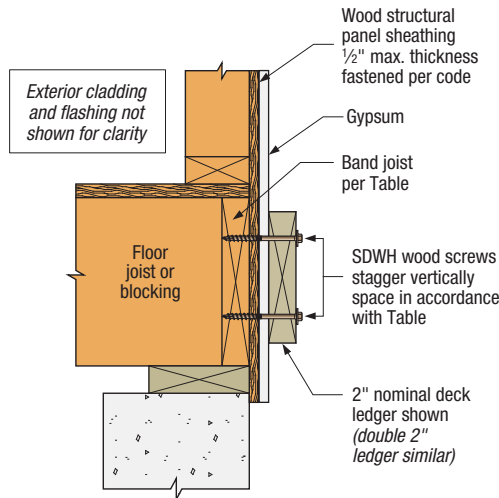

Ledger-to-Rim Board Assembly

(Wood-framed lower floor acceptable, concrete wall shown for illustration purposes)

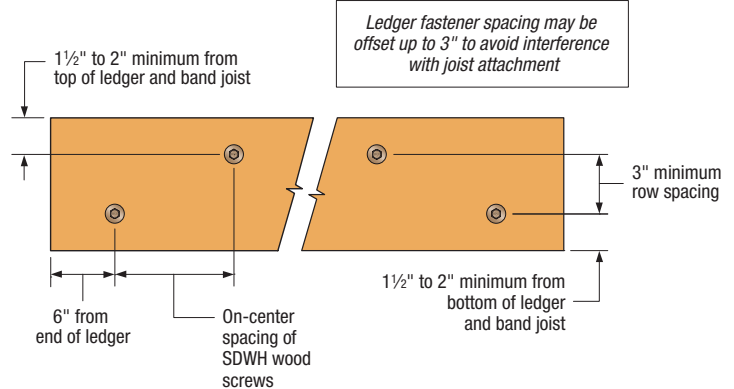

SDWH Screw Spacing Detail

C-F-2017 © 2017 SIMPSON STRONG-TIE COMPANY INC.

Load Tables, Technical Data and Installation Instructions

Strong-Drive® SDWH TIMBER-HEX Screw with Gypsum Board Interlayer(s) (cont.)

SDWH Timber-Hex Screw – Allowable Shear Loads for Ledger Attachment to Studs with One or Two Layers of 5/8" Gypsum Board

Model No.	Length (in.)	Nominal Ledger Size (in.)	Number of Screws per Stud	Allowable Shear Load (lb.)		
				DF	SPF/HF	SP
SDWH19600DB	6	2x6	2	410	350	410
		2x8	3	530	530	410
		2x10	4	760	635	—

- Allowable loads shall be limited to parallel-to-grain loaded solid sawn main members (minimum 2" nominal). Wood side members shall be loaded perpendicular to grain.
- Allowable loads are based on DF, SPF/HF, and SP wood members having a minimum specific gravity of 0.50, 0.42, and 0.55, respectively. Where the side and main members have different specific gravities, the lower values shall be used.
- Allowable loads are shown at the wood load duration factor of $C_D = 1.00$. Loads may be increased for load duration as permitted by the building code up to a $C_D = 1.60$. All adjustment factors shall be applied per the 2012 National Design Specification (NDS). For in-service moisture content greater than 19%, use $C_M = 0.70$.
- Fasteners shall be centered in the stud and spaced as shown in the figure. The ledger minimum end distance is 6". The stud minimum end distance is 6" when the load is toward the end and 2 1/2" when the load is away from the end. For ledger end distances between 2" and 6", use half of table loads and pre drill with 1/8" drill bit.
- Screws may be installed with an interlayer of wood structural panel (WSP) between the framing and the gypsum panel(s). When a WSP is present, it shall be a maximum of 1/2" thick, adjacent to the framing and fastened directly to the framing per code. Minimum screw penetration into the framing of 2 1/2" shall be required; longer screw lengths shall be used to achieve the required penetration.
- For LRFD values, the reference connection design values shall be adjusted in accordance with the NDS-12, section 10.3.
- For 2x10 SP ledgers, use the number of screws and allowable loads of the 2x8 SP ledger.
- For 2x8 ledgers with two screws, use 2x6 values. For 2x10 ledgers with three screws, use 2x8 values. Spacings and edge distances shown in the figure are minimum dimensions.
- For loads in the opposite direction from that shown in the figure, use the table values multiplied by: 0.50 for two screw connections, 0.67 for three screw connections, and 0.75 for four screw connections.
- Gypsum board must be attached as required per the building code.

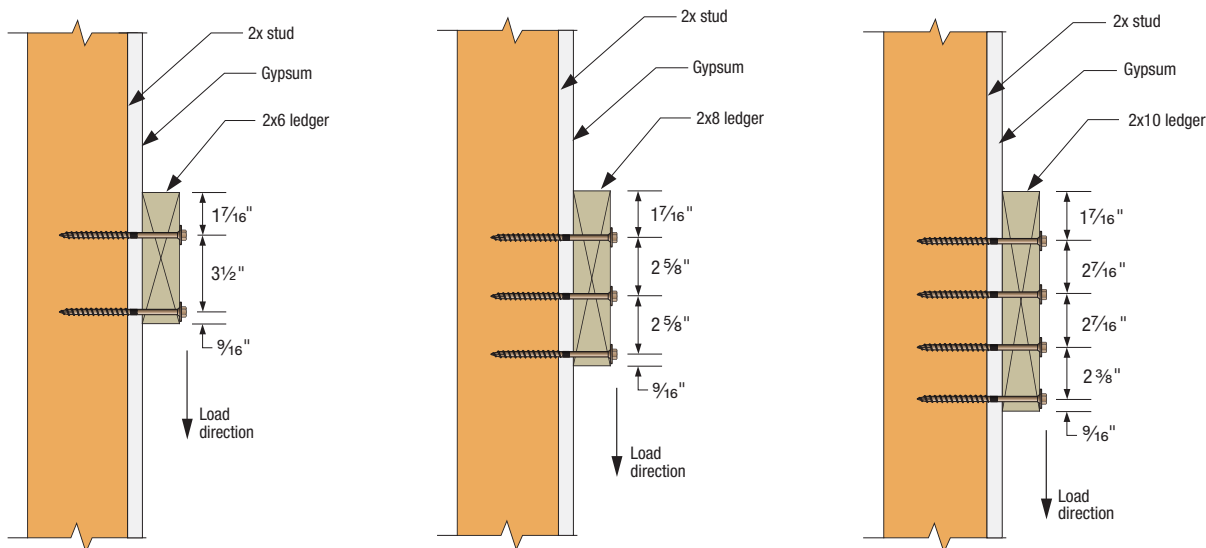

Notes to Installer Regarding the Attachment of Ledgers to Studs:

The screws must be installed into the middle of the stud with a tolerance of 3/16" either side of center. Various methods can be used to ensure proper placement of the screws in the stud including snapping a chalk line, using a stud finder, or prerocking (attaching only a strip of gypsum at the ledger location until the ledger is fastened to the studs). If proper screw placement into the stud cannot be achieved in the field, blocking should be installed between studs to receive and support the ledger screws.

Load Tables, Technical Data and Installation Instructions

Strong-Drive® SDWH TIMBER-HEX HDG Screw

Structural Wood-to-Wood Connections

The Strong-Drive® line of structural screws includes a 0.276" diameter hot-dip galvanized screw suitable for heavy-duty marine and coastal applications. The SDWH Timber-Hex HDG screw has a SawTooth™ point and oversized integral washer that makes for fast installations; no predrilling or separate washer needed.

Codes/Standards: IAPMO-UES ER-192, City of Los Angeles RR25906, State of Florida FL13975

For More Product Information, see p. 72

U.S. Patent Pending

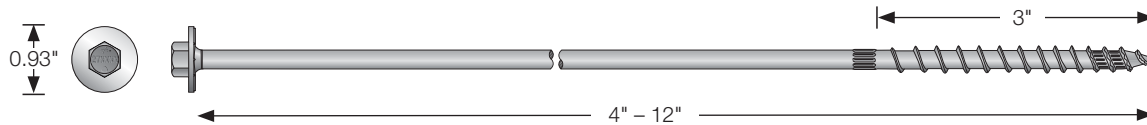

Round Pilings

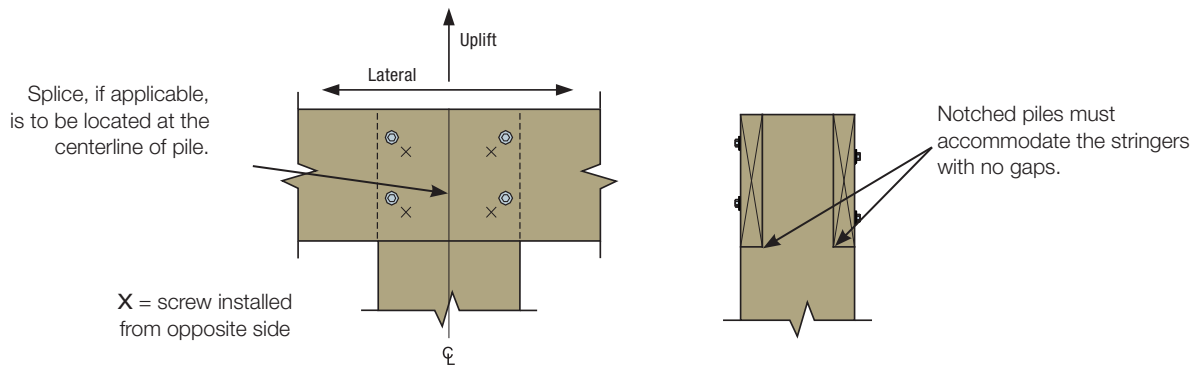

SDWH Timber-Hex HDG – Stringer-to-Round Pile Connection Loads

Round Pile Diameter (in.)	Nominal Stringer Size (in.)	Total No. Stringers	Screw Length (in.)	Model No.	No. Screws (Each Side)	Allowable Connection Loads (lb.)					
						Uplift			Lateral		
						Continuous	Spliced	End	Continuous	Spliced	End
10	2 x 10	2	10	SDWH271000G	4	3,965	2,960	2,140	3,430	3,190	2,875
12	2 x 10	2	12	SDWH271200G	4	3,725	3,130	2,240	4,000	3,645	3,505
14	2 x 10	2	12	SDWH271200G	4	1,865	1,565	1,120	2,000	1,825	1,755
10	2 x 10	4	10	SDWH271000G	4	4,590	3,745	2,785	3,430	3,190	2,875
12	2 x 10	4	12	SDWH271200G	4	7,055	4,975	4,140	4,990	4,165	3,130
12	2 x 12	4	12	SDWH271200G	6	8,735	5,330	4,750	6,000	5,470	5,260
14	2 x 10	4	12	SDWH271200G	4	3,530	2,490	2,070	2,495	2,085	1,565
14	2 x 12	4	12	SDWH271200G	6	4,370	2,665	2,375	3,000	2,735	2,630

- All tabulated values are based on double shear action with the same size and quantity of stringers on each side of the pile.
- Dimensions and allowable connection loads are based on notched piles that must accommodate the stringers with adequate bearing and no gaps. Notched piles shall not be notched such that more than 50% of the cross section is removed. Unnotched piles may be used providing the width and area of wood between the stringers and the fastener placement geometry is unchanged from the notched conditions.
- Allowable loads are shown at the wood load duration factor of $C_D=1.0$. Loads may be increased for load duration per the building code up to a $C_D=1.6$. Tabulated values must be multiplied by all applicable adjustment factors per the NDS.
- For in-service moisture content greater than 19%, use $C_M = 0.68$.
- For conditions with stringers on one side only, use the longest screw length that does not extend beyond the opposite surface of the pile. Use one quarter of the loads shown for that length screw and stringer condition.
- Wood piles are SP. Wood stringers may be sawn lumber, glulam, or SCL with minimum SG = 0.55 (or equivalent). For stringer widths at least 1.5" and less than 3.0" thick, use the table values for the conditions with a single 2x stringer on each side of the pile.
- For 14" diameter piles, use the same screw pattern as for the 12" piles. Loads for 14" diameter piles are based on single shear action.
- When a screw is loaded simultaneously in more than one direction, the allowable load must be evaluated using the unity equation: $(\text{Design Uplift} \div \text{Allowable Uplift}) + (\text{Design F1} \div \text{Allowable F1}) + (\text{Design F2} \div \text{Allowable F2}) \leq 1.0$. The three terms in the unity equation represent the possible generated force directions. The number of terms that must be considered for simultaneous loading is the sole discretion of the Designer and depends on the method of calculating wind forces and the utilization of the screws within the structural system.

Load Tables, Technical Data and Installation Instructions

Strong-Drive® SDWH TIMBER-HEX HDG Screw (cont.)

SDWH Timber-Hex HDG – Allowable Single Shear and Withdrawal Loads

Screw Length (in.)	Screw Diameter (in.)	Thread Length (in.)	Model No.	Allowable Shear Loads (lb.)						Allowable Withdrawal Load W (lb./in.)			Max. Withdrawal Load W _{MAX} (lb.)				
				Wood Side Member Thickness (in.)						SP	DF	HF/SPF	SP	DF	HF/SPF		
				1.5		3		1.5								3	
				1.5	3	1.5	3	1.5	3								
4	0.276	3	SDWH27400G	505	—	440	—	400	—	287	255	212	860	765	635		
6	0.276	3	SDWH27600G	505	545	440	545	400	450								
8	0.276	3	SDWH27800G	570	675	430	675	430	595								
10	0.276	3	SDWH271000G	570	675	430	675	430	595								
12	0.276	3	SDWH271200G	570	675	430	675	430	595								
15	0.276	3	SDWH271500G	570	675	430	675	430	595								

- All shear loads are based on full penetration into the main member. Full penetration is the screw length minus the side member thickness.
- Allowable loads are shown at the wood load duration factor of $C_D=1.0$. Loads may be increased for load duration per the building code up to a $C_D=1.6$. Tabulated values must be multiplied by all applicable adjustment factors per the NDS.
- For in-service moisture content greater than 19% : withdrawal $C_M=0.65$; shear $C_M=0.70$.
- When using tabulated single shear loads for multiple fasteners, minimum fastener spacing requirements: 8" end distance, 1 1/2" edge distance, 5/8" between staggered rows of fasteners, 4" between non-staggered rows of fasteners and 8" between fasteners in a row, multiply the table values by 0.80.
- Tabulated loads are for both parallel and perpendicular to grain loading.
- Maximum withdrawal loads are based on the length of threads in the main member.
- SDWH271500G is not included in IAPMO-UES-ER-192.

Refer to engineering letter L-F-SDWH27GSQ16 for square pile connection loads and details.

Refer to engineering letter L-F-SDWH27GRD16 for round pile connection loads and details.

Load Tables, Technical Data and Installation Instructions

Strong-Drive® SDWH TIMBER-HEX HDG Screw Beam-to-Top-of-Post Connection

The Simpson Strong-Tie® Strong-Drive® SDWH TIMBER-HEX HDG (SDWH27G) structural wood screws may be used to attach a 6x or 8x beam to the top of a post. The screws are available with a hot-dip galvanized coating in accordance with ASTM A153, Class C, suitable for severe exposure applications including preservative treated woods in general exterior construction (AWPA UC4C). The screw is the subject of IAPMO-UES ER-192.

See illustrations for two beam-to-post conditions using the SDWH27G to make the connection. Minimum fastener spacing requirements are shown below. The following table provides allowable shear and uplift loads tested in accordance with ICC-ES AC233, when installed through the top of a wood beam into the end grain of a wood post.

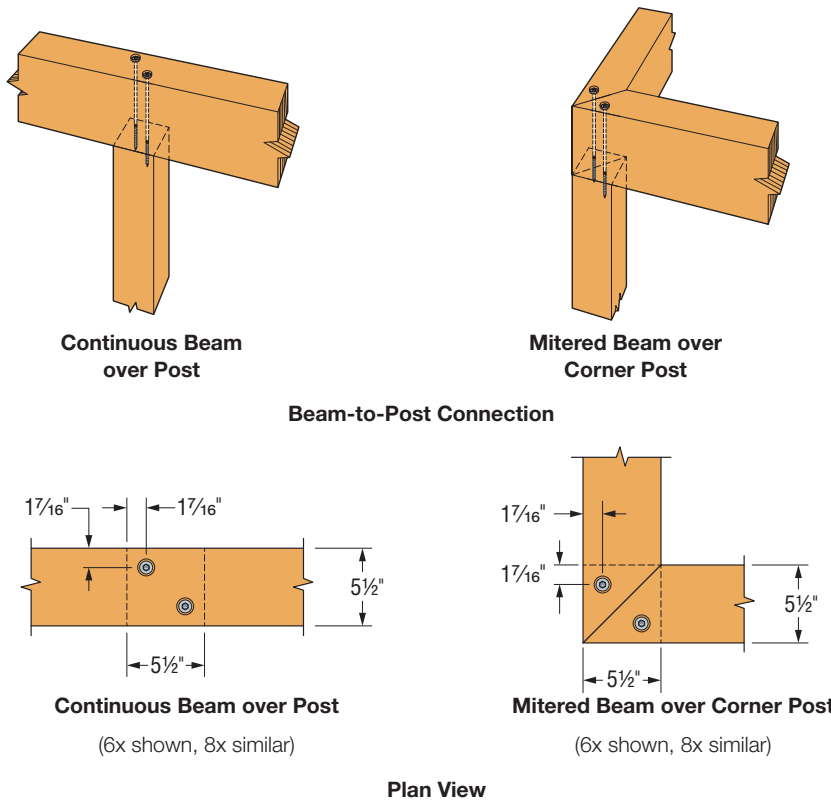

SDWH Timber-Hex HDG – Allowable Uplift Loads for Beam-to-Top-of-Post Connections

Screw Length (in.)	Model No.	Thread Length (in.)	Screws per Post	Max Beam Depth (in.)	DF/SP Allowable Load per Post (lb.)			
					Mitered Beam over Corner Post		Continuous Beam	
					Uplift	Shear	Uplift	Shear
8	SDWH27800G	3	2	5	905	665	920	725
10	SDWH271000G	3	2	7				
12	SDWH271200G	3	2	9				
15	SDWH271500G	3	2	12				

1. Allowable loads are shown at the wood load duration factor of $C_D = 1.0$. Loads may be increased for load duration per the building code up to $C_D = 1.6$. Tabulated values must be multiplied by all applicable adjustment factors per NDS.
2. Tabulated loads are based on entire threaded length installed into post.
3. For in-service moisture content greater than 19%: shear $C_M = 0.70$, withdrawal $C_M = 0.65$.

4. Tabulated shear loads are for the beam loaded parallel or perpendicular to grain with the SDWH27G embedded in the end grain of the post.
5. Tabulated loads are total for the connection, not per screw.
6. Maximum beam depths account for no countersinking of the screw. Screws may be countersunk a maximum of $\frac{1}{2}$ " depth with no reduction in allowable loads which will allow the 8", 10" and 12" screw lengths to be installed in 6x, 8x, 10x and 12x nominal beam depths respectively.

Load Tables, Technical Data and Installation Instructions

Strong-Drive® SDWH TIMBER-HEX SS Screw

Structural Wood-to-Wood Connections Including Ledgers

Type 316 stainless steel for maximum corrosion protection.

For More Product Information, see p. 71

SDWH SS – Allowable Shear Loads-Douglas Fir-Larch, Southern Pine, Spruce-Pine-Fir, Hem-Fir

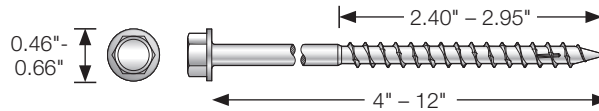

Size (in.)	Model No.	Thread Length (in.)	Allowable Shear Loads (lb.)		
			Wood Side Member Thickness (in.)		
			1½	3	3½
0.188 x 4	SDWH19400SS	2.40	177	—	—
0.188 x 4½	SDWH19450SS	2.75	177	177	—
0.188 x 5	SDWH19500SS	2.40	177	177	177
0.188 x 6	SDWH19600SS	2.40	177	177	177
0.188 x 8	SDWH19800SS	2.40	177	177	177
0.276 x 4	SDWH27400SS	2.95	235	—	—
0.276 x 5	SDWH27500SS	2.95	235	235	235
0.276 x 6	SDWH27600SS	2.95	235	235	235
0.276 x 8	SDWH27800SS	2.95	235	235	235
0.276 x 10	SDWH271000SS	2.95	235	235	235
0.276 x 12	SDWH271200SS	2.95	235	235	235

- All applications are based on full penetration into the main member. Full penetration is the screw length minus the side member thickness.
- Allowable loads are shown at the load duration factor of $C_D = 1.0$. Loads may be increased for load duration per the building code up to a $C_D = 1.6$. Tabulated values must be multiplied by all applicable adjustment factors per the NDS.
- Table values based on testing in SPF lumber.
- Minimum fastener spacing requirements: 3" end distance, 1 7/16" edge distance, 1 1/2" between staggered rows of fasteners, 3" between non-staggered rows of fasteners and 3" between fasteners in a row.
- Design values include NDS wet service factor; no adjustment required for in-service moisture content greater than 19%.
- Allowable loads are perpendicular or parallel to grain.
- Installs best with 18v high-torque cordless or 1/2" low speed drill. If splitting occurs predrill with 5/32" drill bit for 0.188" screws and 7/32" drill bit for 0.276" screws.
- Allowable withdrawal load for the 0.188" screw for DF/SP is 155 lb./in. and for SPF/HF is 108 lb./in. Allowable load is based on inches of thread penetration into the main member.
- Allowable withdrawal load for the 0.276" screw for DF/SP is 260 lb./in. and for SPF/HF is 160 lb./in. Allowable load is based on inches of thread penetration into the main member.
- For LRFD values, the reference connection design values shall be adjusted in accordance with NDS-12, section 10.3.

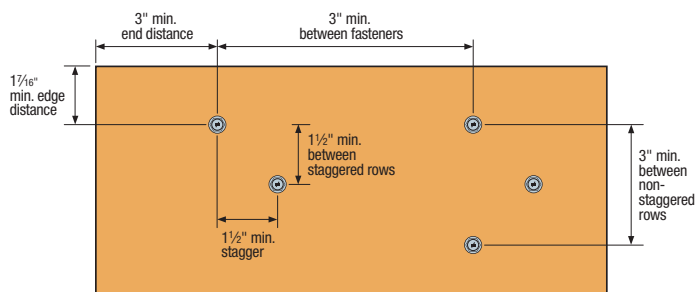

SDWH SS Screw Spacing Detail

Load Tables, Technical Data and Installation Instructions

Strong-Drive®

SDWH TIMBER-HEX SS Screw (cont.)

SDWH SS – 2012 and 2015 IRC Compliant Spacing for a Sawn Lumber Deck Ledger-to-Rim Board – 0.188" Screws

Loading Condition	Nominal Ledger Thickness (in.)	Screw Length and Model No.	Rim Board Material and Size	Maximum Deck Joist Span						
				Up to 6 ft.	Up to 8 ft.	Up to 10 ft.	Up to 12 ft.	Up to 14 ft.	Up to 16 ft.	Up to 18 ft.
				Maximum On-Center Spacing of Fasteners (in.)						
40 psf Live 10 psf Dead	2x	4" SDWH19400SS	1" OSB	14	11	8	7	6	5	5
			1" LVL							
			1 1/8" OSB	14	11	8	7	6	5	5
			1 5/16" LVL							
			1 1/4" OSB							
			1 1/2" LVL							
			1 1/4" LSL	14	11	8	7	6	5	5
			1 3/4" LVL							
2x SP, DF, SPF, HF	14	11	8	7	6	5	5			
60 psf Live 10 psf Dead	2x	4" SDWH19400SS	1" OSB	10	8	6	5	4	4	3
			1" LVL							
			1 1/8" OSB	10	8	6	5	4	4	3
			1 5/16" LVL							
			1 1/4" OSB							
			1 1/2" LVL							
			1 1/4" LSL	10	8	6	5	4	4	3
			1 3/4" LVL							
2x SP, DF, SPF, HF	10	8	6	5	4	4	3			
40 psf Live 10 psf Dead	(2) 2x	5" SDWH19500SS	1" OSB	14	11	8	7	5	5	5
			1" LVL							
			1 1/8" OSB	14	11	8	7	5	5	5
			1 5/16" LVL							
			1 1/4" OSB							
			1 1/2" LVL							
			1 1/4" LSL	14	11	8	7	5	5	5
			1 3/4" LVL							
2x SP, DF, SPF, HF	14	11	8	7	5	5	5			
60 psf Live 10 psf Dead	(2) 2x	5" SDWH19500SS	1" OSB	10	8	6	5	4	4	3
			1" LVL							
			1 1/8" OSB	10	8	6	5	4	4	3
			1 5/16" LVL							
			1 1/4" OSB							
			1 1/2" LVL							
			1 1/4" LSL	10	8	6	5	4	4	3
			1 3/4" LVL							
2x SP, DF, SPF, HF	10	8	6	5	4	4	3			

- Screw spacing values are equivalent to 2012/2015 IRC Table R507.2. The table above also provides screw spacing for a wider range of materials commonly used for band joists, and an alternate loading condition as required by some jurisdictions.
- Sawn rim board shall be Spruce-Pine-Fir, Hem-Fir, Douglas Fir-Larch, or Southern Pine species. Ledger shall be Hem-Fir, Douglas Fir-Larch, or Southern Pine species.
- Fastener spacings are based on the lesser of single fastener ICC-ES AC233 testing with a safety factor of 5.0 or ledger assembly testing with a factor of safety of 5.0. Spacing includes NDS wet service factor adjustment.
- Multiple ledger plies shall be fastened together per code independent of the screws.

- Rows of screws shall be vertically offset and evenly staggered. Screws shall be placed 1 1/2" to 2" from the top and bottom of the ledger or rim board with 3" minimum and 6" maximum between rows and spaced per the table. End screws shall be located 6" from the end and at 1 1/2" to 2" from the bottom of the ledger. For screws located at least 2" but less than 6" from the end, use 50% of the load per screw and 50% of the table spacing between the end screw and the adjacent screw, and for screws located between 2" and 4" from the end, predrill using a 7/32" drill for SDWH19 SS and 7/32" drill for SDWH27 SS.
- Structural sheathing between the ledger and band shall be a maximum of 1/2" thick and fastened per code.
- See figure on following page.

Load Tables, Technical Data and Installation Instructions

Strong-Drive® SDWH TIMBER-HEX SS Screw (cont.)

SDWH SS – 2012 and 2015 IRC Compliant Spacing for a Sawn Lumber Deck Ledger-to-Rim Board – 0.276" Screws

Loading Condition	Nominal Ledger Thickness (in.)	Screw Length and Model No.	Rim Board Material and Size	Max Deck Joist Span						
				Up to 6 ft.	Up to 8 ft.	Up to 10 ft.	Up to 12 ft.	Up to 14 ft.	Up to 16 ft.	Up to 18 ft.
				Max On-Center Spacing of Fasteners (in.)						
40 psf Live 10 psf Dead	2x	4" SDWH27400SS	1" OSB	19	14	11	9	8	7	6
			1" LVL							
			1 1/8" OSB							
			1 5/16" LVL							
			1 1/4" OSB							
			1 1/2" LVL							
			1 1/4" LSL							
1 3/4" LVL										
			2x SP, DF, SPF, HF	19	14	11	9	8	7	6
60 psf Live 10 psf Dead	2x	4" SDWH27400SS	1" OSB	13	10	8	7	6	5	4
			1" LVL							
			1 1/8" OSB							
			1 5/16" LVL							
			1 1/4" OSB							
			1 1/2" LVL							
			1 1/4" LSL							
1 3/4" LVL										
			2x SP, DF, SPF, HF	13	10	8	7	6	5	4
40 psf Live 10 psf Dead	(2) 2x	5" SDWH27500SS	1" OSB	19	14	11	9	8	7	6
			1" LVL							
			1 1/8" OSB							
			1 5/16" LVL							
			1 1/4" OSB							
			1 1/2" LVL							
			1 1/4" LSL							
1 3/4" LVL										
			2x SP, DF, SPF, HF	19	14	11	9	8	7	6
60 psf Live 10 psf Dead	(2) 2x	5" SDWH27500SS	1" OSB	13	10	8	7	6	5	4
			1" LVL							
			1 1/8" OSB							
			1 5/16" LVL							
			1 1/4" OSB							
			1 1/2" LVL							
			1 1/4" LSL							
1 3/4" LVL										
			2x SP, DF, SPF, HF	13	10	8	7	6	5	4

1. See footnotes on previous page.

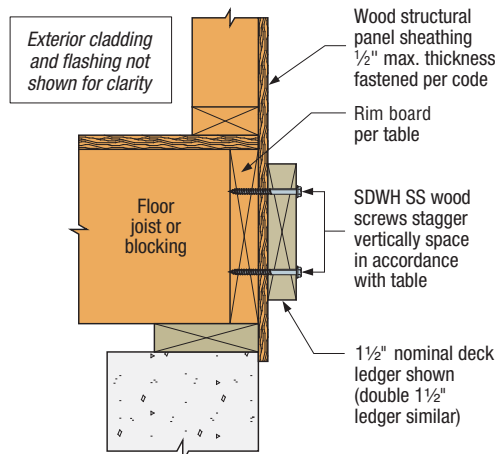

Ledger-to-Rim Board Assembly

(Wood-framed lower floor acceptable; concrete wall shown for illustration purposes)

Fastener Types

Fastener Types and Sizes Specified for Simpson Strong-Tie® Connectors

Many Simpson Strong-Tie connectors have been designed and tested for use with specific types and sizes of fasteners. The specified quantity, type and size of fastener must be installed in the correct holes on the connector to achieve published loads. Other factors such as fastener material and finish are also important. Incorrect fastener selection or installation can compromise connector performance and could lead to failure. For more information about fasteners, access our Fastener Finder software at strongtie.com/ff.

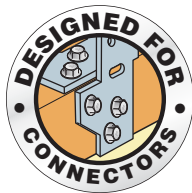

The Simpson Strong-Tie® Strong-Drive® SD Connector screw, SDS Heavy-Duty Connector screw and SDWS Timber screw are the only screws approved for use with our connectors.

Stainless Steel

The allowable loads of stainless-steel connectors match those of carbon-steel connectors when installed with Simpson Strong-Tie® stainless-steel, SCNR ring-shank nails. For more information, refer to engineering letter L-F-SSNAILS at strongtie.com.

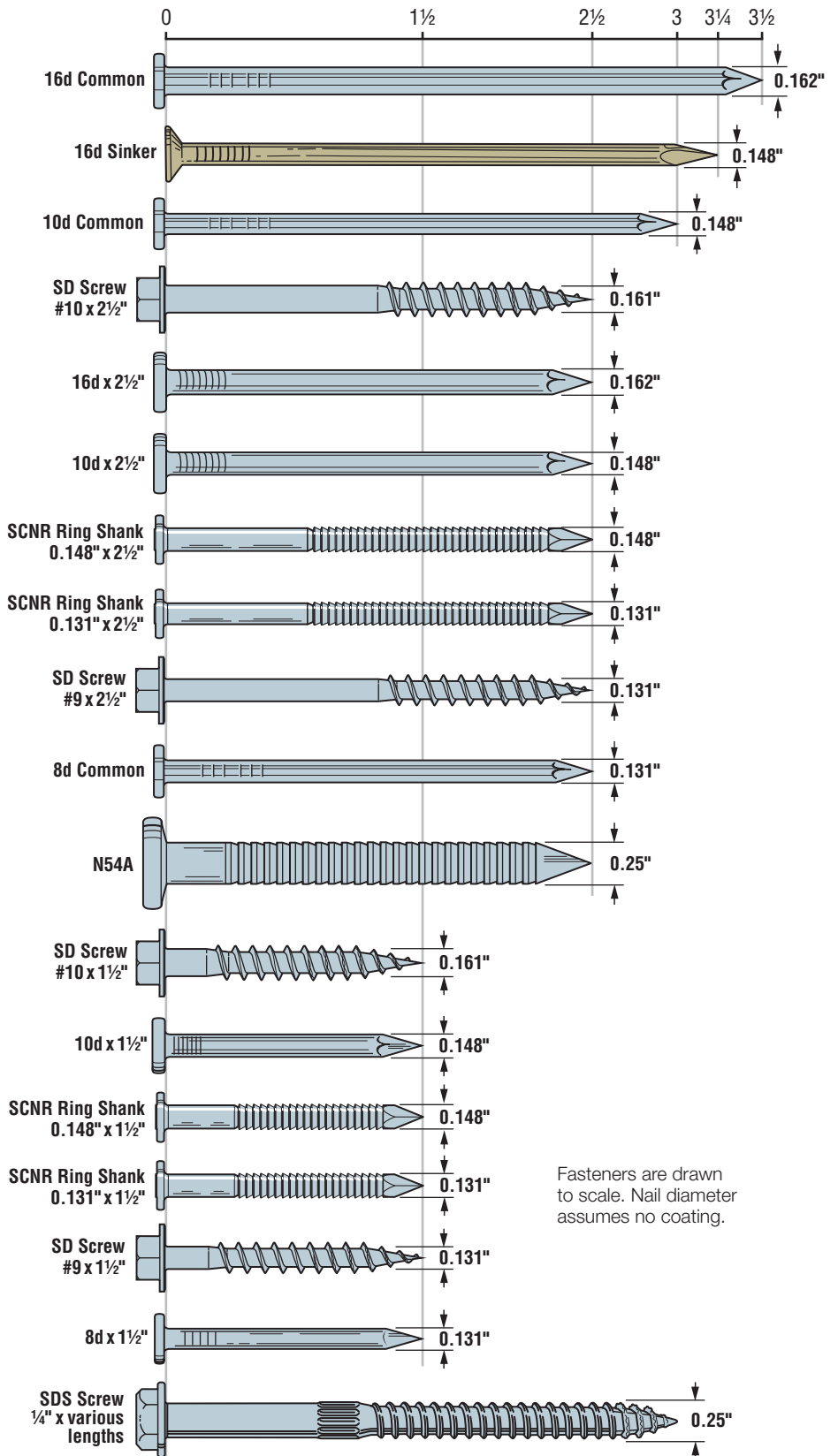

Fasteners are drawn to scale. Nail diameter assumes no coating.

Fastener Types

In some cases, it is desirable to install Simpson Strong-Tie face-mount joist hangers and straight straps with nails that are a different type or size than what is called out in the load table. In these cases, these reduction factors must be applied to the allowable loads listed for the connector.

Load Adjustment Factors for Optional Fasteners Used with Face Mount Hangers and Straight Straps

Catalog Nail	Replacement	Allowable Load Adjustment Factor	
		Face Mount Hangers	Straight Straps ⁷
16d common (0.162" x 3½")	10d x 1½ (0.148" x 1½")	0.64	0.84 ⁸
16d common (0.162" x 3½")	10d common (0.148" x 3")	0.84	0.84
	12d common (0.148" x 3¼")		
	16d sinker (0.148" x 3¼")		
16d common (0.162" x 3½")	16d x 2½ (N16) (0.162" x 2½")	1.00	1.00
10d common (0.148" x 3")	10d x 2½ (0.148" x 2½")	0.85	1.00
10d common (0.148" x 3")	10d x 1½ (0.148" x 1½")	0.77	1.00 ⁹
16d sinker (0.148" x 3¼")			
10d common (0.148" x 3")	10d x 1¼ (0.148" x 1¼")	0.64	1.00 ⁹
16d sinker (0.148" x 3¼")			
10d common (0.148" x 3")	16d sinker (0.148" x 3¼")	1.00	1.00
8d common (0.131" x 2½")	8d x 1½ (0.131" x 1½")	0.85	1.00
10d common (0.148" x 3")	8d common (0.131" x 2½")	0.83	0.83
16d common (0.162" x 3½")	SD #10 x 1½ (0.161" x 1½")	1.00 ⁵	1.00 ⁵
16d x 2½ (N16) (0.162" x 2½)			
10d common (0.148" x 3")			
16d sinker (0.148" x 3¼")			
10d x 1½ (0.148" x 1½)			
8d common (0.131" x 2½")	SD #9 x 1½ (0.131" x 1½")	1.00 ⁵	1.00 ⁵
8d x 1½ (0.131" x 1½")			

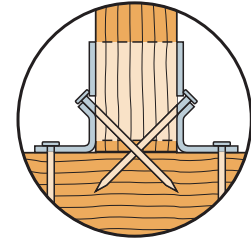

Double-shear nailing shall use minimum 3" long nails

1. Allowable load adjustment factors shown in the table are applicable for all face mount hangers and straight straps throughout this catalog, except as noted in the footnotes below.
2. Some products have been tested specifically with alternate fasteners and have allowable load adjustment factors or reduced capacities published on the specific product page. Those values on the product page may be used in lieu of the values calculated using this table.
3. This table does not apply to SUR/SUL/HSUR/HSUL hangers or to hangers modified per allowed options, or to connectors made from steel thicker than 10 ga. Allowable loads for SUR/SUL/HSUR/HSUL hangers installed with Strong-Drive® SD Connector screws can be found online in engineering letter L-C-SLSKHGRSD16.
4. Strong-Drive® SD Connector screw substitutions in this table do not apply to sloped, skewed or double-shear hangers except those noted in L-C-SLSKHGRSD16. For additional information and specific allowable loads, refer to strongtie.com/sd.
5. Nails and Strong-Drive SD Connector screws may not be combined in a connection.
6. Do not substitute 10d x 1½" nails for face nails on slope and skew combinations or skewed only LSU and LSSU.
7. For straps installed over sheathing use a 2½" long fastener minimum.
8. Where noted, use 0.80 for 10 ga., 11 ga., and 12 ga. products when using SPF lumber.
9. Where noted, use 0.92 for 10 ga., 11 ga., and 12 ga. products when using SPF lumber.

Fastening Identification



Round Holes
Purpose: To fasten a connector.
Fill Requirements: Always fill, unless noted otherwise.

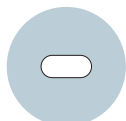

Obround Holes
Purpose: To make fastening a connector in a tight location easier.
Fill Requirements: Always fill.

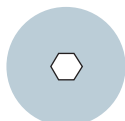

Hexagonal Holes
Purpose: To fasten a connector to concrete or masonry.
Fill Requirements: Always fill when fastening a connector to concrete or masonry.

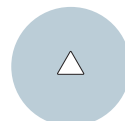

Triangular Holes
Purpose: To increase a connector's strength or to achieve Max strength.
Fill Requirements: When the Designer specifies max. nailing.

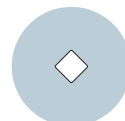

Diamond Holes
Purpose: To temporarily fasten a connector to make installing it easier.
Fill Requirements: None.

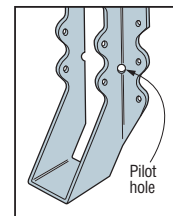

Pilot Holes
Tooling holes for manufacturing purposes. No fasteners required.

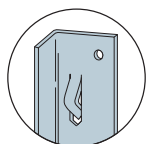

Speed Prongs
Used to temporarily position and secure the connector for easier and faster installation.
328

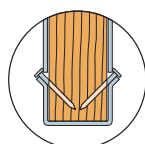

Positive Angle Nailing (PAN)
Provided when wood splitting may occur, and to speed installation.

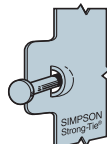

Dome Nailing
This feature guides the nail into the joist and header at a 45° angle.
U.S. Patent 5,603,580

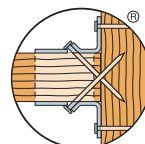

Double-Shear Nailing
The nail is installed into the joist and header, distributing the load through two points on each joist nail for greater strength.

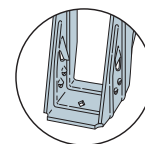

ITS/IUS Strong-Grip™
The Strong-Grip™ seat allows the I-joist to "snap" in securely without the need for joist nails.

Load Tables, Technical Data and Installation Instructions

Strong-Drive® SDS HEAVY-DUTY CONNECTOR Screw

Heavy-Duty Simpson Strong-Tie® Connectors

The Simpson Strong-Tie® Strong-Drive® SDS screw is a ¼" diameter high-strength structural wood screw ideal for various connector installations as well as wood-to-wood and EWP fastening applications.

Install Tips: A low-speed ½" drill with a ⅜" hex driver (BITHEXR38-134) is the recommended tool for installation.

Codes/Standards: ICC-ES ESR-2236; City of L.A. RR25711, State of Florida FL9589

U.S. Patents 5,897,280; 7,101,133

For More Product Information, see p. 75

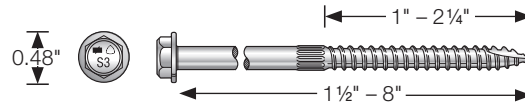

SDS – Allowable Shear Loads-Steel Side-Plate Applications

Size (in.)	Thread Length (in.)	Coating/Material	Model No.	DF/SP Allowable Shear Loads (lb.)			SPF/HF Allowable Loads (lb.)		
				Steel Side Plate Thickness, mil (ga.)			Steel Side Plate Shear, mil (ga.)		
				54 (16)	68 and 97 (14 and 12)	123 (10) or greater	54 (16)	68 and 97 (14 and 12)	123 (10) or greater
¼ x 1½	1	Double-barrier coating	SDS25112	250	250	250	180	180	180
¼ x 2	1¼		SDS25200	250	290	290	180	210	210
¼ x 2½	1½		SDS25212	250	390	420	180	280	300
¼ x 3	2		SDS25300	250	420	420	180	300	300
¼ x 3½	2¼		SDS25312	250	420	420	180	300	300
¼ x 4½	2¾		SDS25412	250	420	420	180	300	300
¼ x 5	2¾		SDS25500	250	420	420	180	300	300
¼ x 6	3¼		SDS25600	250	420	420	180	300	300
¼ x 8	3¼	SDS25800	250	420	420	180	300	300	
¼ x 1½	1	Type 316 stainless steel	SDS25112SS	250	250	250	180	180	180
¼ x 2½	1½		SDS25212SS	250	390	420	180	280	300
¼ x 3	2		SDS25300SS	250	420	420	180	300	300
¼ x 3½	2¼		SDS25312SS	250	420	420	180	300	300

1. Screws may be provided with the 4CUT™ or Type-17 point.
2. Allowable loads are shown at the wood load duration factor of $C_D = 1.00$. Loads may be increased for load duration up to a $C_D = 1.60$.
3. Allowable withdrawal load for DF/SP/SCL is 172 lb./in. and for SPF/HF withdrawal is 121 lb./in. Total withdrawal load is based on actual thread penetration into the main member.

4. LSL wood-to-wood applications that require 4½", 5", 6" and 8" SDS screws are limited to interior-dry use only.
5. Minimum spacing requirements are listed in ICC-ES ESR-2236.

Load Tables, Technical Data and Installation Instructions

Strong-Drive®

SDS HEAVY-DUTY CONNECTOR Screw (cont.)

SDS – Allowable Shear Loads – Douglas Fir-Larch and Southern Pine Lumber^{5,6,7}

Size (in.)	Model No.	DF/SP Allowable Shear Loads ² (lb.)														
		Wood Side Plate Thickness (in.)														
		½	⅝	¾	1	1⅛	1¼	1½	1¾	2½	3	3½	4	4½		
¼ x 2	SDS25200	145	—	—	—	—	—	—	—	—	—	—	—	—	—	—
¼ x 2½	SDS25212	165	165	170	165	—	—	190 ¹	—	—	—	—	—	—	—	—
¼ x 3	SDS25300	165	165	170	185	195	205	280 ¹	—	—	—	—	—	—	—	—
¼ x 3½	SDS25312	165	165	170	185	195	205	340 ¹	340 ¹	—	—	—	—	—	—	—
¼ x 4½	SDS25412	165	165	170	185	195	205	350 ¹	340 ¹	230	200	—	—	—	—	—
¼ x 5	SDS25500	165	165	170	185	195	205	350 ¹	340 ¹	230	230	200	—	—	—	—
¼ x 6	SDS25600	165	165	170	185	195	205	350 ¹	340 ¹	340 ¹	340 ¹	340 ¹	230	200	—	—
¼ x 8	SDS25800	165	165	170	185	195	205	350 ¹	340 ¹	340 ¹	340 ¹	340 ¹	230	230	—	—

SDS – Allowable Shear Loads - Spruce-Pine-Fir and Hem-Fir^{5,6,7}

Size (in.)	Model No.	SPF/HF Allowable Shear Loads ² (lb.)														
		Wood Side Plate Thickness (in.)														
		½	⅝	¾	1	1⅛	1¼	1½	1¾	2½	3	3½	4	4½		
¼ x 2	SDS25200	105	—	—	—	—	—	—	—	—	—	—	—	—	—	—
¼ x 2½	SDS25212	130	135	130	120	—	—	135 ¹	—	—	—	—	—	—	—	—
¼ x 3	SDS25300	130	140	140	150	150	145	200 ¹	—	—	—	—	—	—	—	—
¼ x 3½	SDS25312	130	140	140	150	155	165	245 ¹	245 ¹	—	—	—	—	—	—	—
¼ x 4½	SDS25412	130	140	140	150	155	165	250 ¹	245 ¹	190	160	—	—	—	—	—
¼ x 5	SDS25500	130	140	140	150	155	165	250 ¹	245 ¹	190	190	160	—	—	—	—
¼ x 6	SDS25600	130	140	140	150	155	165	250 ¹	245 ¹	245 ¹	245 ¹	245 ¹	190	160	—	—
¼ x 8	SDS25800	130	140	140	150	155	165	250 ¹	245 ¹	245 ¹	245 ¹	245 ¹	195	195	—	—

1. Noted loads are based on testing per ICC-ES AC233 and assume a minimum main member thickness of the screw length minus the side member thickness. All other allowable loads are based on the NDS-2012 and a minimum penetration of $6D = 1.45"$ into the main member.

2. Values are valid for a connection involving only two members. Where the side and main members have different specific gravities, the lower values shall be used.

3. Allowable loads are also applicable to structural composite lumber (e.g., LVL, PSL, and LSL) having an equivalent specific gravity of 0.50 or greater.

4. Allowable loads are shown at the wood load duration factor of

$C_D = 1.00$. Loads may be increased for load duration by the building code up to a $C_D = 1.60$. The Designer shall apply all adjustment factors required per NDS.

5. Loads are based on installation into the side grain of the wood members with the screw axis perpendicular to the wood fibers.

6. Loads apply to corresponding stainless-steel models.

7. For in-service moisture greater than 19% use $C_M = 0.7$.

Load Tables, Technical Data and Installation Instructions

Strong-Drive® SDS HEAVY-DUTY CONNECTOR Screw (cont.)

SDS – Allowable Double-Shear Loads – Douglas Fir-Larch, Southern Pine, Spruce-Pine-Fir

Size (in.)	Model No.	Side Members	Allowable Shear Loads (lb.)		
			DF	SP	SPF
¼ x 3	SDS25300	2 ³ / ₃₂ " wood structural panel rated sheathing	355	325	305
¼ x 4½	SDS25412	2x solid sawn	395	475	335

1. Allowable loads are based on Simpson Strong-Tie® laboratory testing with a safety factor of 5.0 applied to the average ultimate test load.
2. Allowable loads are based on 1½" thick main members and assume no gap between side and main members.
3. Allowable loads are shown at the wood load duration factor of C_D = 1.00. Loads may be increased for load duration by the building code up to a C_D = 1.60. The Designer shall apply all adjustment factors required per NDS.
4. For applications with 2x side members, use allowable loads based on the lower of side member or main member species.
5. The Designer is responsible for the design of wood members.

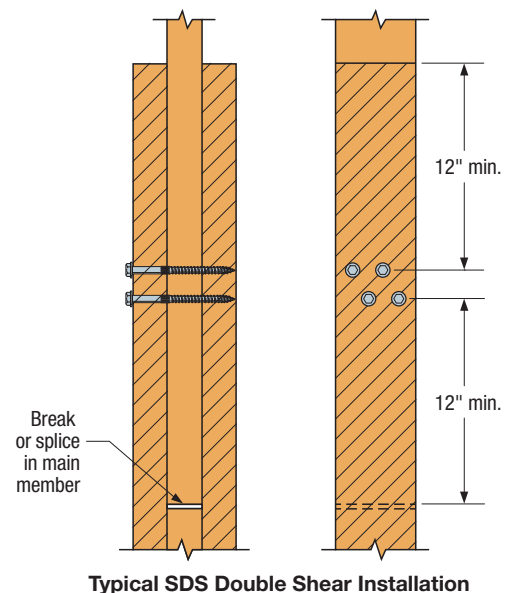
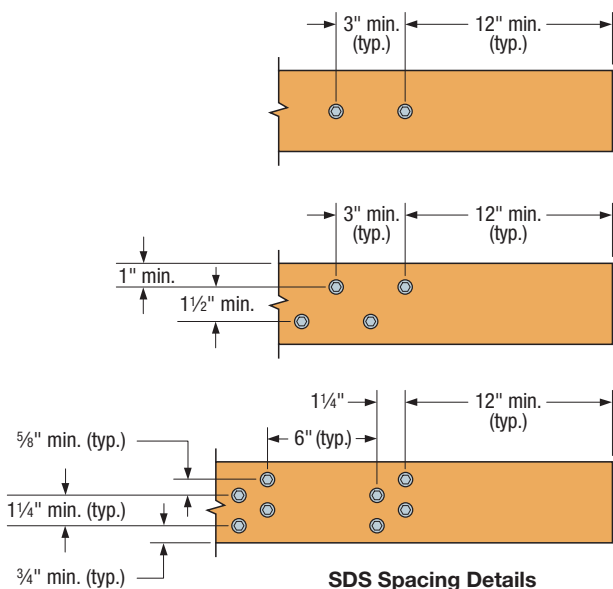

SDS – Allowable Shear Loads – Installations into the Narrow Face of 2X SPF, HF, DF, SP Lumber

Size (in.)	Model No.	Wood Side Member Actual Thickness (in.)	Minimum Main Member Penetration ⁵ (in.)	DF/SP Allowable Shear Loads (lb.)	SPF/HF Allowable Shear Loads (lb.)
¼ x 3½	SDS25312	1½	2	250	190
¼ x 4½	SDS25412			250	190

1. Allowable loads are based on testing per ICC AC233 and are limited to parallel-to-grain loaded solid-sawn main members (2" nominal). Wood side members may be loaded parallel or perpendicular to grain (see footnote 4).
2. DF/SP allowable loads are based on wood members having a minimum specific gravity of 0.50, and SPF/HF allowable loads are based on wood members having a minimum specific gravity of 0.42. Where the side and main members have different specific gravities, the lower values shall be used.
3. Allowable loads are shown at the wood load duration factor of C_D = 1.00. Loads may be increased for load duration by the building code up to a C_D = 1.60.
4. Minimum spacing of fasteners is 3" o.c., minimum end distance is 3" for all parallel-to-grain loaded members, or 4" for all perpendicular-to-grain loaded members, and minimum edge distance is ¾" for all parallel-to-grain loaded members, or 1½" for perpendicular-to-grain loaded side members.
5. Screws may be installed with an intermediate layer of wood structural panel between the side and main member provided the wood structural panel is fastened to the main member per code and the minimum penetration of the screw into the main member (excluding the wood structural panel) is met.

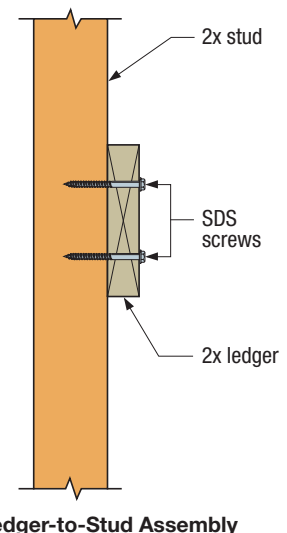

Load Tables, Technical Data and Installation Instructions

Strong-Drive® SDS HEAVY-DUTY CONNECTOR Screw (cont.)

Code-Compliant Spacing for a Sawn Lumber Deck Ledger to Rim Board

Loading Condition	Ledger Nominal Size (in.)	SDS Screw Length (in.)	Rim Board Material and Size	Maximum Deck Joist Span						
				Up to 6 ft.	Up to 8 ft.	Up to 10 ft.	Up to 12 ft.	Up to 14 ft.	Up to 16 ft.	Up to 18 ft.
				Maximum On-Center Spacing of Fasteners (in.)						
40 psf Live 10 psf Dead	2x	3½	2" nominal sawn lumber	13	10	8	6	5	5	4
	(2) 2x³	5								
	2x	3½	1" min. oriented strand board (OSB) rim board	12	9	7	6	5	4	4
	2x	3½	1½" min. oriented strand board (OSB) rim board or 1¼" min. structural composite lumber	15	11	9	7	6	5	5
60 psf Live 10 psf Dead	2x	3½	2" nominal sawn lumber	9	7	5	4	4	3	3
	(2) 2x³	5								
	2x	3½	1" min. oriented strand board (OSB) rim board	8	6	5	4	3	3	2
	2x	3½	1½" min. oriented strand board (OSB) rim board or 1¼" min. structural composite lumber	10	8	6	5	4	4	3

1. Solid-sawn band joists shall be Spruce-Pine-Fir, Hem-Fir, Douglas Fir-Larch, or Southern Pine species. Ledger shall be Hem-Fir, Douglas Fir-Larch, or Southern Pine species.
2. Fastener spacings are based on single fastener testing of the Strong-Drive® SDS screw with a safety factor of 5.0 and include NDS wet service adjustment factor.
3. Multiple ledger plies shall be fastened together per code independent of the SDS screws.
4. SDS screw spacing values (above) are equivalent to 2009 IRC Table R502.2.2.1 and 2012/2015 IRC Table R507.2, based on testing of the Strong-Drive® SDS screw with a factor of safety of 5.0. The table above also provides SDS screw spacing for a wider range of materials commonly used for rim board, and an alternate loading condition as required by some jurisdictions.
5. Screw models SDS25312, SDS25312SS and SDS25500.

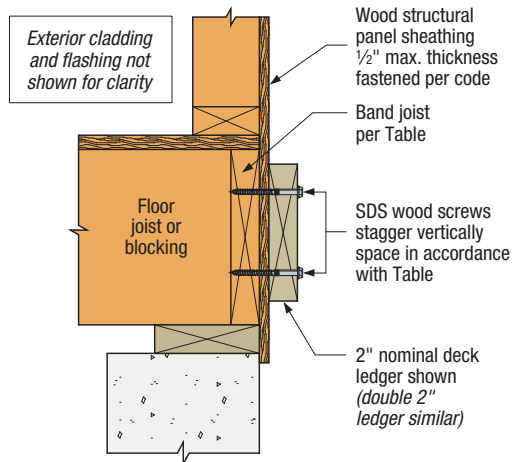

Ledger-to-Rim Board Assembly

(Wood-framed lower floor acceptable, concrete wall shown for illustration purposes)

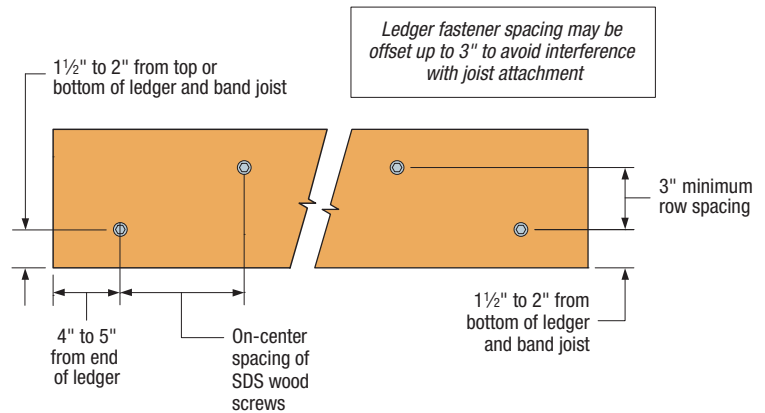

SDS Screw Spacing Detail for Ledgers

Load Tables, Technical Data and Installation Instructions

Strong-Drive®

SDS HEAVY-DUTY CONNECTOR Screw (cont.)

SDS – Allowable Shear Values for Sole-to-Rim Connections

Size (in.)	Model No.	Sole Plate Nominal Size (in.)	Minimum Penetration into Rim Board (in.)	Allowable Loads (lb.)							
				2x DF/SP Rim Board		2x SPF/HF Rim Board		1 1/4" Min. LVL Rim Board		1 1/4" Min. LSL Rim Board	
				DF/SP Sole Plate	SPF/HF Sole Plate	DF/SP Sole Plate	SPF/HF Sole Plate	DF/SP Sole Plate	SPF/HF Sole Plate	DF/SP Sole Plate	SPF/HF Sole Plate
1/4 x 4.5	SDS25412	2x	2	250	190	190	190	190	190	220	190
1/4 x 5	SDS25500	2x	2	250	190	190	190	190	190	220	190
1/4 x 6	SDS25600	2x or 3x	2	250	190	190	190	190	190	220	190

1. Allowable loads are based on testing per ICC-ES AC233 and are limited to parallel-to-grain loading.
2. Allowable loads are shown at the wood load duration factor of $C_D = 1.00$. Loads may be increased for load duration by the building code up to a $C_D = 1.60$.
3. Minimum spacing of the SDS for sawn lumber applications is 3" o.c., minimum end distance is 3", and minimum edge distance is 5/8".
4. Minimum spacing of the SDS for LVL and LSL applications is 6" o.c., minimum end distance is 6", and minimum edge distance is 5/8".
5. Wood structural panel up to 1 1/8" thick is permitted between the sole plate and rim board provided it is fastened to the rim board per code and the minimum penetration of the screw into the rim board is met.
6. A double 2x sole plate is permitted provided it is independently fastened per the code and the minimum screw penetration per the table is met.

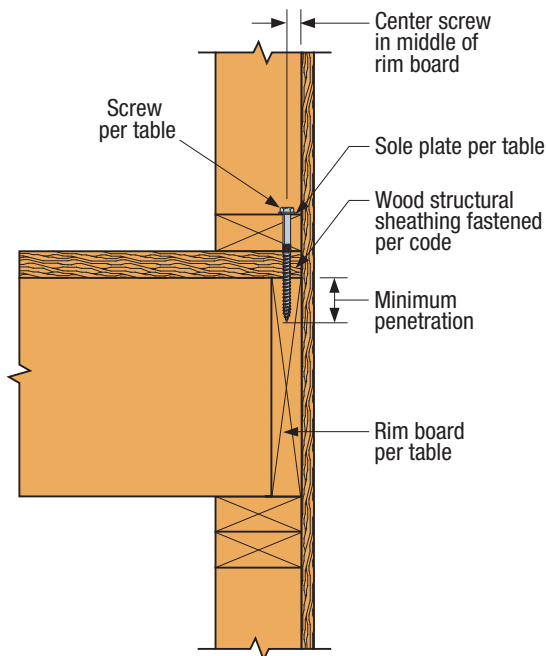

Sole-to-Rim Board Assembly

Load Tables, Technical Data and Installation Instructions

Strong-Drive® SD CONNECTOR Screw

Simpson Strong-Tie® Connectors

Codes/Standards: ICC-ES ESR-3046, State of Florida FL9589

U.S. Patent 7,101,133

For More Product Information, see p. 76

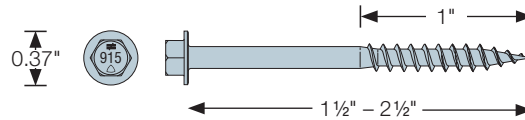

SD – Allowable Shear Loads – Steel Side Plate

Size (in.)	Model No.	Thread Length (in.)	Allowable Shear Loads with Steel Side Plates (lb.)	
			DF/SP	SPF/HF
#9 x 1½	SD9112	1	171	112
#9 x 2½	SD9212	1	200	112
#10 x 1½	SD10112	1	173	138
#10 x 2½	SD10212	1	215	165

1. Loads are given for $C_D=1.0$ and may be increased for load duration per the building code to $C_D=1.60$.

2. Steel side plate thickness is 33 to 100 mil (20 – 12 ga.).

SD – Allowable Shear Loads – DFL, SP, SPF, HF Side Plate

Size (in.)	Model No.	Thread Length (in.)	DF/SP Allowable Shear Loads (lb.)			SPF/HF Allowable Shear Loads (lb.)		
			Wood Side Plate Thickness (in.)			Wood Side Plate Thickness (in.)		
			1½/32 – 1/2	23/32 – 3/4	1½	15/32 – 1/2	23/32 – 3/4	1½
#9 x 1½	SD9112	1	105	—	—	93	—	—
#9 x 2½	SD9212	1	118	133	130	99	94	109
#10 x 1½	SD10112	1	127	—	—	102	—	—
#10 x 2½	SD10212	1	147	168	152	106	126	123

1. Allowable loads are shown at the wood load duration factor of $C_D = 1.00$. Loads may be increased for load duration per the building code up to a $C_D = 1.60$.

2. The 1½/32" and 23/32" side members must be plywood or OSB with minimum equivalent specific gravities of 0.50 for DF and SP design values, and 0.42 for SPF and HF design values.

3. Loads are based on installation into the side grain of the wood members with the screw axis perpendicular to the wood fibers.

SD – Allowable Withdrawal Loads – DF, SP, SPF, HF Lumber

Size	Model No.	Fastener Length (in.)	Thread Length (in.)	Reference Withdrawal Design Value, W (lb./in.)	
				DF and SP Main Member	SPF and HF Main Member
#9 x 1½	SD9112	1.5	1.0	173	122
#9 x 2½	SD9212	2.5			
#10 x 1½	SD10112 / SD10112DBB	1.5		173	122
#10 x 2½	SD10212	2.5			

1. The tabulated reference withdrawal design value, W, is in pounds per inch of the thread penetration into the side grain of the main member.

2. Tabulated reference withdrawal design value, W, must be multiplied by all applicable adjustment factors from the NDS as referenced in the IBC or IRC.

3. Embedded thread length is that portion held in the main member including the screw tip.

4. For connections with 1½/32" thick plywood or OSB side members, reference withdrawal design values, W, must be limited by the head pull-through design value of 130 lb.

Load Tables, Technical Data and Installation Instructions

Strong-Drive® SD CONNECTOR Screw (cont.)

Connectors Approved for Use with the Strong-Drive® SD Structural-Connector Screw

These connectors are code listed under ICC-ES ESR-3096 when installed with the SD screw. Check with your local building department to determine whether the correct size of SD structural-connector screw may be used as a suitable substitute for nails.

Since testing of the SD structural-connector screw is ongoing, Simpson Strong-Tie will continue to add newly-approved connectors to this list. For the most current list of approved connectors, load values and applications visit strongtie.com/sd.

Model No.	SD9 Qty.		SD10 Qty.		Model No.	SD9 Qty.		SD10 Qty.		Model No.	SD9 Qty.		SD10 Qty.	
	1½"	2½"	1½"	2½"		1½"	2½"	1½"	2½"		1½"	2½"	1½"	2½"
A21	(4)	—	—	—	HGUS26-4	—	—	—	(28)	HSUR/L46	—	(16)	—	—
A23	(8)	—	—	—	HGUS28-4	—	—	—	(48)	HSUR/L410	—	(26)	—	—
A33	(8)	—	—	—	HGUS210-4	—	—	—	(62)	HSUR/L414	—	(34)	—	—
A34	(8)	—	—	—	HGUS212-4	—	—	—	(76)	HSUR/L4.12/9	(12)	(2)	—	—
A35	(12)	—	—	—	HGUS214-4	—	—	—	(88)	HSUR/L4.12/11	(16)	(2)	—	—
A44	(8)	—	—	—	HGUS46	—	—	—	(28)	HSUR/L4.12/14	(20)	(2)	—	—
ABA44Z	(6)	—	—	—	HGUS48	—	—	—	(48)	HSUR/L4.12/16	(24)	(2)	—	—
ABA44RZ	(6)	—	—	—	HGUS410	—	—	—	(62)	HSUR/L4.28/9	(12)	(2)	—	—
ABA46Z	—	—	(8)	—	HGUS412	—	—	—	(76)	HSUR/L4.28/11	(16)	(2)	—	—
ABA66Z	—	—	(8)	—	HGUS414	—	—	—	(88)	HSUR/L4.28/11	(16)	(2)	—	—
ABA66RZ	—	—	(8)	—	HGUS2.75/10	—	—	—	(62)	HSUR/L4.75/9	(12)	(2)	—	—
ABU44Z	—	—	(12)	—	HGUS2.75/12	—	—	—	(76)	HSUR/L4.75/11	(16)	(2)	—	—
ABW44Z	(8)	—	—	—	HGUS2.75/14	—	—	—	(88)	HSUR/L4.75/14	(20)	(2)	—	—
ABW44RZ	(8)	—	—	—	HGUS3.25/10	—	—	—	(62)	HSUR/L4.75/16	(24)	(2)	—	—
ABW46Z	(10)	—	—	—	HGUS3.25/12	—	—	—	(76)	HSUR/L5.12/9	(12)	(2)	—	—
ABW46RZ	(10)	—	—	—	HGUS5.25/10	—	—	—	(62)	HSUR/L5.12/11	(16)	(2)	—	—
ABW66Z	(12)	—	—	—	HGUS5.25/12	—	—	—	(76)	HSUR/L5.12/14	(20)	(2)	—	—
ABW66RZ	(12)	—	—	—	HGUS5.50/8	—	—	—	(48)	HSUR/L5.12/16	(24)	(2)	—	—
AC4	—	—	(28)	—	HGUS5.50/10	—	—	—	(62)	HTT4	—	—	(18)	—
AC6	—	—	(28)	—	HGUS5.50/12	—	—	—	(76)	HTT5	—	—	(26)	—
BC4	—	—	(12)	—	HGUS5.50/14	—	—	—	(88)	HTU26	(31)	—	—	—
BC40	—	—	(10)	—	HGUS5.62/10	—	—	—	(62)	HTU26 (Min.)	(34)	—	—	—
BC60	—	—	(10)	—	HGUS5.62/12	—	—	—	(76)	HTU26 (Max.)	(40)	—	—	—
BCS2-2 /4	—	(14)	—	—	HGUS5.62/14	—	—	—	(88)	HTU28 (Min.)	(40)	—	—	—
CTS218	(24)	—	—	—	HGUS6.88/10	—	—	—	(62)	HTU28 (Max.)	(52)	—	—	—
DJT14Z	—	—	—	(8)	HGUS6.88/12	—	—	—	(76)	HTU210 (Min.)	(46)	—	—	—
DPT5Z ¹	(5)	—	—	—	HGUS6.88/14	—	—	—	(88)	HTU210 (Max.)	(64)	—	—	—
DPT7Z ¹	(5)	—	—	—	HGUS7.25/8	—	—	—	(48)	HTU26-2 (Min.)	(34)	—	—	—
EPB44	—	—	(8)	—	HGUS7.25/10	—	—	—	(62)	HTU26-2 (Max.)	(40)	—	—	—
EPB44PHDG	—	—	(8)	—	HGUS7.25/12	—	—	—	(76)	HTU28-2 (Min.)	(40)	—	—	—
EPC4Z	(18)	—	—	—	HGUS7.25/14	—	—	—	(88)	HTU28-2 (Max.)	(52)	—	—	—
EPC6Z	(18)	—	—	—	HHUS26-2	—	—	—	(20)	HTU210-2 (Min.)	(46)	—	—	—
EPC8Z	(18)	—	—	—	HHUS28-2	—	—	—	(30)	HTU210-2 (Max.)	(64)	—	—	—
FB24Z ¹	(5)	—	—	—	HHUS210-2	—	—	—	(40)	HUS26	—	—	—	(20)
FB24R ¹	(5)	—	—	—	HHUS210-3	—	—	—	(40)	HUS28	—	—	—	(30)
FB26 ¹	(6)	—	—	—	HHUS210-4	—	—	—	(40)	HUS210	—	—	—	(40)
FBFZ ¹	(4)	—	—	—	HHUS46	—	—	—	(20)	HUS26-2	—	—	—	(8)
FBR24Z ¹	(5)	—	—	—	HHUS48	—	—	—	(30)	HUS28-2	—	—	—	(12)
FPBM44 ¹	(8)	—	—	—	HHUS410	—	—	—	(40)	HUS210-2	—	—	—	(16)
FWH2 ¹	(16)	—	—	—	HHUS5.50/10	—	—	—	(40)	HUS212-2	—	—	—	(20)
GA1	(4)	—	—	—	HHUS7.25/10	—	—	—	(40)	HUS46	—	—	—	(8)
GA2	(6)	—	—	—	HHRC2-2	—	—	—	(62)	HUS48	—	—	—	(12)
H1	(10)	—	—	—	HHRC42-2	—	—	—	(62)	HUS410	—	—	—	(16)
H2.5	(10)	—	—	—	HHRC4/1.81	—	—	—	(62)	HUS412	—	—	—	(20)
H2.5A	(10)	—	—	—	HHRC44	—	—	—	(62)	HUS1.81/10	—	—	—	(40)
H4	(8)	—	—	—	HHRC5.25/3.25	—	—	—	(62)	KBS1Z	(12)	—	—	—
H8	(10)	—	—	—	HHRC5.37/3.12	—	—	—	(62)	L30	(4)	—	—	—
H10A	(18)	—	—	—	HHRC5.37/3.56	—	—	—	(62)	L50	(6)	—	—	—
H10A-2	(18)	—	—	—	HHRC5.25/3.62	—	—	—	(62)	L70	(8)	—	—	—
HGUS26	—	—	—	(28)	HHRC64	—	—	—	(67)	L90	(10)	—	—	—
HGUS28	—	—	—	(48)	HHRC66	—	—	—	(67)	LCE4	—	—	(24)	—
HGUS26-2	—	—	—	(28)	HPTZ	—	—	(8)	—	LPC4Z	(16)	—	—	—
HGUS28-2	—	—	—	(48)	HRS6	(6)	—	—	—	LRU26Z	—	—	—	(9)
HGUS210-2	—	—	—	(62)	HRS8	(10)	—	—	—	LRU28Z	—	—	—	(10)
HGUS26-3	—	—	—	(28)	HRS12	(14)	—	—	—	LRU210Z	—	—	—	(12)
HGUS28-3	—	—	—	(48)	HTP37Z	(20)	—	—	—	LRU212Z	—	—	—	(13)
HGUS210-3	—	—	—	(62)	HSUR/L26-2	—	(16)	—	—	LSCZ	(17)	—	—	—
HGUS212-3	—	—	—	(76)	HSUR/L210-2	—	(26)	—	—	LSTA9	(8)	—	—	—
HGUS214-3	—	—	—	(88)	HSUR/L214-2	—	(34)	—	—	LSTA12	(10)	—	—	—

1. These connectors are not load rated.

Load Tables, Technical Data and Installation Instructions

Strong-Drive®

SD CONNECTOR Screw (cont.)

Connectors Approved for Use with the Strong-Drive® SD Structural-Connector Screw

These connectors are code listed under ICC-ES ESR-3096 when installed with the SD screw. Check with your local building department to determine whether the correct size of SD structural-connector screw may be used as a suitable substitute for nails.

Since testing of the SD structural-connector screw is ongoing, Simpson Strong-Tie will continue to add newly-approved connectors to this list. For the most current list of approved connectors, load values and applications visit strongtie.com/sd.

Model No.	SD9 Qty.		SD10 Qty.		Model No.	SD9 Qty.		SD10 Qty.		Model No.	SD9 Qty.		SD10 Qty.	
	1½"	2½"	1½"	2½"		1½"	2½"	1½"	2½"		1½"	2½"	1½"	2½"
LSTA15	(12)	—	—	—	LSSU2.1	(7)	(10)	—	—	RTT22Z	(10)	—	—	—
LSTA18	(14)	—	—	—	LSSUI35	(7)	(10)	—	—	ST9	—	—	(8)	—
LSTA21	(14)	—	—	—	LSSUH310	—	(30)	—	—	ST12	—	—	(10)	—
LSTA24	(14)	—	—	—	LSSU210-2	—	(30)	—	—	ST18	—	—	(12)	—
ST292	—	—	(12)	—	LSSU410	—	(30)	—	—	ST22	—	—	(12)	—
ST2122	—	—	(12)	—	LSU4.12	—	(40)	—	—	ST292	—	—	(12)	—
ST2115	—	—	(6)	—	LSU4.28	—	(40)	—	—	ST2115	—	—	(6)	—
ST2215	—	—	(14)	—	LSU3510-2	—	(40)	—	—	ST2122	—	—	(12)	—
LSTA30	(14)	—	—	—	LSU5.12	—	(40)	—	—	ST2215	—	—	(14)	—
LSTA36	(14)	—	—	—	MST27	—	—	(30)	—	ST6215	—	—	(16)	—
LSTI49	(16)	—	—	—	MST37	—	—	(40)	—	ST6224	—	—	(20)	—
LSTI73	(16)	—	—	—	MST48	—	—	(52)	—	ST6236	—	—	(28)	—
LTP4	(12)	—	—	—	MST60	—	—	(68)	—	SUR/L24	(8)	—	—	—
LU24 (10d)	(6)	—	—	—	MST72	—	—	(70)	—	SUR/L26	(12)	—	—	—
LU26 (10d)	(10)	—	—	—	MSTA12	(12)	—	—	—	SUR/L210	(20)	—	—	—
LU28 (10d)	(10)	—	—	—	MSTA15	(10)	—	—	—	SUR/L214	(24)	—	—	—
LU210 (10d)	—	—	(10)	—	MSTA18	(14)	—	—	—	SUR/L1.81/9	(14)	—	—	—
LUC26Z (10d)	(14)	—	—	—	MSTA21	(14)	—	—	—	SUR/L1.81/11	(18)	—	—	—
LUC26Z (16d)	(16)	—	—	—	MSTA24	(14)	—	—	—	SUR/L1.81/14	(22)	—	—	—
LUC210Z (10d)	(16)	—	—	—	MSTA30	(16)	—	—	—	SUR/L2.06/9	(16)	—	—	—
LUC210Z (16d)	—	—	(16)	—	MSTA36	(16)	—	—	—	SUR/L2.06/11	(18)	—	—	—
LUS24	(4)	(2)	—	—	MSTA49	(16)	—	—	—	SUR/L2.06/14	(20)	—	—	—
LUS26	(4)	(4)	—	—	MSTA9	(8)	—	—	—	SUR/L2.06/14	(20)	—	—	—
LUS28	(6)	(4)	—	—	MSTC28	(36)	—	—	—	SUR/L2.1/9	(16)	—	—	—
LUS210	(8)	(4)	—	—	MSTC40	(46)	—	—	—	SUR/L2.1/11	(18)	—	—	—
LUS36	(4)	(4)	—	—	MSTC52	(42)	—	—	—	SUR/L2.1/14	(20)	—	—	—
LUS310	(6)	(4)	—	—	MSTC66	(44)	—	—	—	SUR/L2.1/14	(20)	—	—	—
LUS24-2	(4)	(2)	—	—	MSTC78	(44)	—	—	—	SUR/L2.37/9	(16)	—	—	—
LUS26-2	(4)	(4)	—	—	MSTI26	(26)	—	—	—	SUR/L2.37/11	(18)	—	—	—
LUS28-2	(6)	(4)	—	—	MSTI36	(36)	—	—	—	SUR/L2.37/14	(20)	—	—	—
LUS210-2	(8)	(6)	—	—	MSTI48	(38)	—	—	—	SUR/L2.37/14	(20)	—	—	—
LUS214-2	(10)	(6)	—	—	MSTI60	(38)	—	—	—	SUR/L2.56/9	(16)	—	—	—
LUS26-3	(4)	(4)	—	—	MSTI72	(60)	—	—	—	SUR/L2.56/11	(18)	—	—	—
LUS28-3	(6)	(4)	—	—	MTS12	(14)	—	—	—	SUR/L2.56/14	(20)	—	—	—
LUS210-3	(8)	(6)	—	—	MTS16	(14)	—	—	—	SUR/L2.56/14	(20)	—	—	—
LUS44	(4)	(2)	—	—	MTS20	(14)	—	—	—	SUR/L26-2	(12)	—	—	—
LUS46	(4)	(4)	—	—	NS1'	(2)	—	—	—	SUR/L210-2	(20)	—	—	—
LUS48	(6)	(4)	—	—	NS2'	(2)	—	—	—	SUR/L214-2	(26)	—	—	—
LUS410	(8)	(6)	—	—	PA51	(10)	—	—	—	SUR/L46	(12)	—	—	—
LUS414	(10)	(6)	—	—	PA68	(10)	—	—	—	SUR/L410	(20)	—	—	—
LSU26	(11)	—	—	—	PBS44A	—	—	(14)	—	SUR/L414	(26)	—	—	—
LSSU28	(15)	—	—	—	PC4Z	(18)	—	—	—	THASR/L29	(7)	(12)	—	—
LSSU210	(7)	(10)	—	—	PC6Z	(18)	—	—	—	THASR/L29-2	—	(20)	—	—
LSSUI25	(7)	(10)	—	—	PC8Z	(18)	—	—	—	THASR/L422	—	(20)	—	—
LSSUI2.06	(7)	(10)	—	—	PBS44A	—	—	(14)	—	TJC57	(24)	—	—	—
LSSU2.1	(7)	(10)	—	—	PF24	—	(6)	—	—	TP15'	Varies	—	—	—
LSSUI35	(7)	(10)	—	—	PF26	—	(4)	—	—	TP311'	Varies	—	—	—
LSSUH310	—	(30)	—	—	PSPN58Z ¹	—	—	(4)	—	TP35'	Varies	—	—	—
LSSU210-2	—	(30)	—	—	RR	(8)	—	—	—	TP37'	Varies	—	—	—
LSSU410	—	(30)	—	—	RSP4	(8)	—	—	—	TP39'	Varies	—	—	—
LSU4.12	—	(40)	—	—	RTA12	(16)	—	—	—	TP411'	Varies	—	—	—
LSU4.28	—	(40)	—	—	RTA2Z	(8)	—	—	—	TP45'	Varies	—	—	—
LSU3510-2	—	(40)	—	—	RTA4	(12)	—	—	—	TP47'	Varies	—	—	—
LSU5.12	—	(40)	—	—	RTB22	(8)	—	—	—	TP57'	Varies	—	—	—
LSU26	(11)	—	—	—	RTC22Z	(11)	—	—	—	TP49'	Varies	—	—	—
LSSU28	(15)	—	—	—	RTC2Z	(12)	—	—	—	TPA37'	Varies	—	—	—
LSSU210	(7)	(10)	—	—	RTC42	—	—	(22)	—	TPA39'	Varies	—	—	—
LSSUI25	(7)	(10)	—	—	RTC44	—	—	(29)	—	TPA57'	Varies	—	—	—
LSSUI2.06	(7)	(10)	—	—	RTF2Z	(13)	—	—	—	VTCR	(7)	—	—	—

1. These connectors are not load rated.

Load Tables, Technical Data and Installation Instructions

Strong-Drive® SCNR RING-SHANK CONNECTOR Nail

Simpson Strong-Tie® Connectors

Strong Drive® SCNR Ring-Shank Connector nails are the best choice for achieving maximum load values in stainless-steel connectors.

For More Product Information, see pp. 138, 159

When installing galvanized connectors and straps, use an SCN that is zinc galvanized. If the connectors and straps are stainless steel, then stainless steel SCNRs shall be used.

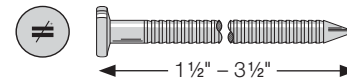

Stainless Steel Nails

The USDA Forest Service, Forest Products Laboratory showed that stainless-steel nails with smooth shanks do not have the same withdrawal resistance as smooth-shank carbon steel nails (Withdrawal strength and bending yield strength of stainless-steel nails, 2015, *Journal of Structural Engineering*). In addition, Simpson Strong-Tie conducted an extensive series of withdrawal testing with stainless-steel nails made from Type 304, Type 305 and Type 316 stainless steels to assess the stainless-steel ring-shank nail withdrawal performance over a wide range of nail diameters (0.072 in. to 0.238 in.) and wood specific gravities (0.42 to 0.55). The withdrawal tests were conducted in accordance with ASTM D1761 using wood conditioned to 12-percent moisture content. Further, the reference allowable withdrawal resistance for each of the tested nails was calculated using the withdrawal calculation for post-frame ring-shank nails in NDS-12, equation 11.2-4 (NDS-15, equation 12.2-4),

$$W = 1800 G^2 D$$

The allowable withdrawal loads for Simpson Strong-Tie stainless-steel ring-shank nails with a safety factor of 5.0 were at or above the calculated reference withdrawal resistance for post-frame ring-shank nails. As a result, the post-frame ring-shank nail equation for reference withdrawal design values can be safely used for Simpson Strong-Tie stainless-steel ring-shank nails of all diameters across the specific gravity range of 0.42 to 0.55. This finding and recommendation are specific to Simpson Strong-Tie stainless-steel ring-shank nails and shall not be applied to stainless-steel ring-shank nails made by other manufacturers.

The bending yield strength of Simpson Strong-Tie stainless-steel nails (smooth and ring-shank) meet the bending yield strength specifications of ASTM F1667, which are the same as those in the IBC and IRC.

Stainless Steel Nails for Connectors

Simpson Strong-Tie stainless-steel connectors are required to be installed using stainless-steel fasteners. Recent testing at Simpson Strong-Tie indicates that allowable load values for some Simpson Strong-Tie stainless-steel connectors have changed when smooth-shank stainless-steel nails are used. Refer to strongtie.com/products/categories/zmax.html for a list of connectors available in stainless-steel, which includes links to load tables for carbon steel and stainless-steel smooth-shank nail installations as applicable.

In cases where these load tables indicate stainless-steel smooth-shank nail installations have reduced loads, full allowable loads listed for the same carbon steel connector may be achieved if the stainless-steel connector is installed with the correct replacement stainless-steel Simpson Strong-Tie® Strong Drive® SCNR Ring-Shank Connector nails as shown in the following Nail Substitution Chart.

Nail Substitution Chart Replacement Ring-Shank Stainless-Steel Nails, Type 316 Stainless Steel

Catalog-Specified Carbon-Steel Smooth-Shank Nail		Replacement Stainless-Steel Strong-Drive SCNR® Ring-Shank Connector Nail	
Type	Size (in.) (Dia. x Length)	Hand-Drive	Collated
N8	0.131 x 1.5	SSNA8	T10A150MCN
8d Common	0.131 x 2.5	SSA8D	T10A250MCN
N10	0.148 x 1.5	SSNA10D	T9A150MCN
10d x 2.5"	0.148 x 2.5	—	T9A250MCN
10d Common	0.148 x 3.0	SSA10D	—
16d Common	0.162 x 3.5	SSA16D	—

1. Collated nails listed are available in 33° paper tape strips.

Over-Driven Nails in Connectors and Straps

A nail that is installed such that the head deforms the steel of the connector or strap is considered over-driven. Extra care to prevent over-driven nails should be taken when installing power-driven nails. Simpson Strong-Tie has evaluated the effect of over-driven nails in connectors and straps. No load reductions for connectors or straps apply as a result of over-driven nails if all of the following conditions are met:

- Connectors and straps are 14-, 16-, or 18-gauge steel.
- The top of the nail head is not driven past flush with the face of the metal hardware.
- The nail goes through an existing fastener hole without enlarging it.
- The steel around the hole is not torn or damaged other than denting caused by the nail head.

Load Tables, Technical Data and Installation Instructions

Strong-Drive® SCN SMOOTH-SHANK CONNECTOR Nail

Simpson Strong-Tie® Connectors

For More Product Information, see pp. 139, 158

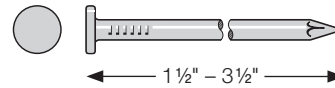

Simpson Strong-Tie connectors have been designed and tested with specific types of nails, which are generally referred to as Structural Connector Nails (SCN). The specified nail size, type and quantity must be installed in the correct holes of the connector or strap to achieve the published loads for the hardware. The dimensions and bending yield strength characteristics needed for nails used in Simpson Strong-Tie connectors and hardware are given in the table below. The designer and installer must be sure that the correct fastener is specified and installed. In cases where the installed nail matches the criteria of the nail specified for the hardware, full hardware design values result.

SCN Smooth-Shank Connector Nails and Common Nails Approved for Use with Simpson Strong-Tie Connectors^{1,2,3}

Fastener	Diameter (in.)	Length (in.)	Head Style	Head Diameter (in.)	Minimum Bending Yield Strength (psi) ^{4,6}
N8	0.131	1.5	Round	0.281	100,000
8d common	0.131	2.5	Round	0.281	100,000
N10	0.148	1.5	Round	0.281	90,000
N10D	0.148	2.5	Round	0.281	90,000
10d common	0.148	3	Round	0.281 ⁵	90,000
N16	0.162	2.5	Round	0.281	90,000
16d common	0.162	3.5	Round	0.281 ⁵	90,000

1. Tolerance on diameter and length per ASTM F1667.
2. Tolerance on head diameter (± 0.0015 in.)
3. All dimensions are prior to coating.
4. Tested in accordance with ASTM F1575.
5. Minimum head diameter shown; actual head diameters on 10d and 16d common nails are larger.
6. Minimum bending yield strengths applicable to SCNR nails of the same diameter.

Power-driven SCNs are often used to install Simpson Strong-Tie connectors and straps. Power-driven nails must have the same dimensions and bending yield strength as hand-driven nails. Dedicated power nailers are designed to drive nails of specific lengths that may be less than the length required to achieve full design values for the connector or strap hardware. When connectors and straps are installed with power-driven nails or hand-driven nails that are a different type or size than those called out in the connector and strap specifications, adjustment factors as given on strongtie.com must be applied to the allowable loads for the connector or strap.

Over-Driven Nails in Connectors and Straps

A nail that is installed such that the head deforms the steel of the connector or strap is considered over-driven. Extra care to prevent over-driven nails should be taken when installing power-driven nails. Simpson Strong-Tie has evaluated the effect of over-driven nails in connectors and straps. No load reductions for connectors or straps apply as a result of over-driven nails if all of the following conditions are met:

- Connectors and straps are 14-, 16-, or 18-gauge steel.
- The top of the nail head is not driven past flush with the face of the metal hardware.
- The nail goes through an existing fastener hole without enlarging it.
- The steel around the hole is not torn or damaged other than denting caused by the nail head.

Load Tables, Technical Data and Installation Instructions

Wafer-Head Screw

General Wood-to-Wood Fastening

For more information, see p. 96

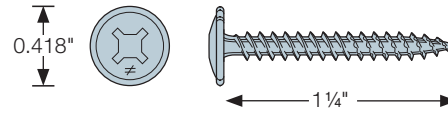

Allowable Loads

Model No.	Size (in.)	Allowable Shear Loads (lb.)		Allowable Withdrawal Loads (lb.)	
		Steel Side Plate Thickness, in. (ga.)			
		0.054 – 0.25 (16-3)			
		DF/SP	SPF/HF	DF/SP	SPF/HF
SD8x1.25	5/32 x 1 1/4	50	45	82	58

1. Allowable loads are shown at the wood load duration factor of $C_D = 1.00$. Loads may be increased for load duration up to a $C_D = 1.60$.
2. SD8x1.25 requires 3/4" minimum penetration into the main member.
3. Do not use SD8x1.25 wood screws with structural connectors unless specified.
4. Warning: Industry studies show that hardened fasteners can experience performance problems in wet or corrosive environments. Accordingly, use this product in dry, interior, and noncorrosive environments only.

Load Tables, Technical Data and Installation Instructions

Strong-Drive® SDWC TRUSS Screw

Truss/Rafter-to-Plate and Stud-to-Plate Connections

The SDWC screw is tested in accordance with ICC-ES AC233 (screw) and AC13 (wall assembly and roof-to-wall assembly) for uplift and lateral loads between wall plates and vertical wall framing and between the top plate and the roof rafters or trusses. SDWC15450 is recognized for use in chemically-treated wood as described in the evaluation report.

Codes/Standards: IAPMO-UES ER-262, State of Florida FL13975

For More Product Information, see p. 92

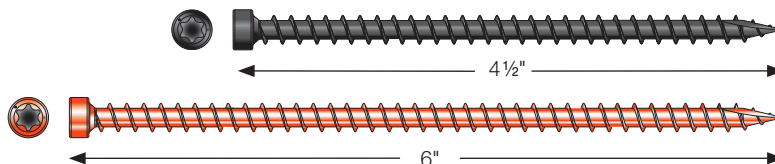

SDWC – Allowable Shear Loads – DF, SP, SPF

Model No.	Fastener Length (in.)	Thread Length (in.)	Nominal Member Thickness (in.)		Allowable Shear Loads (lb.)					
			Side Member	Main Member	Z _{para} ⁴			Z _{perp} ⁵		
					SP	DF	SPF	SP	DF	SPF
SDWC15450	4 1/2	4 1/4	2x (Face)	2x (End grain)	—	—	—	225	205	190
SDWC15600	6	5 3/4	(2)2x (Face)	2x (Edge)	245	240	180	240	240	240
			2x (Face)	2x (End grain)	—	—	—	225	205	190
			(2)2x (Face)	2x (End grain)	—	—	—	225	225	190
			2x (Face)	2x (End grain)	—	—	—	225	205	190

1. Allowable loads are shown at the wood load duration factor of C_D = 1.0. Loads may be increased for load duration up to a C_D = 1.6.
2. Tabulated values must be multiplied by all applicable adjustment factors per the NDS.
3. The main and side members shall be sawn lumber or structural composite lumber with a specific gravity or equivalent specific gravity 0.42 to 0.55.

4. Z_{para} — Parallel to grain loading in the side member and perpendicular to grain loading in the main member.
5. Z_{perp} — Perpendicular to grain loading in the side member and perpendicular to grain loading in the main member, except for 2x (edge) where main member is loaded parallel to grain.
6. The connection conditions of this table are for specific intended applications. Reference lateral design values for all other shear connections are calculated following the NDS.

SDWC – Allowable Withdrawal and Pull-Through Loads – DF, SP, SPF

Model No.	Screw Length (in.)	Thread Length (in.)	Nominal Main Member Thickness (in.)	Allowable Withdrawal Loads (lb./in.)			Allowable Pull-Through Loads (lb./in.)		
				SP	DF	SPF	SP	DF	SPF
SDWC15450	4 1/2	4 1/4	2x (Edge)	250	230	150	—	—	—
			2x (End Grain)	200	140	100	210	180	175
SDWC15600	6	5 3/4	2x (Face)	210	180	120	255	195	160
			(2) 2x (Face)	220	200	160	240	225	190

1. Allowable loads are shown at the wood load duration factor of C_D = 1.0. Loads may be increased for load duration up to a C_D = 1.6.
2. Tabulated values must be multiplied by all applicable adjustment factors per the NDS.

3. The reference withdrawal and pull-through values are in pounds per inch of the thread penetration into the main member and a minimum 1 1/2" thick side member, respectively.

Load Tables, Technical Data and Installation Instructions

Strong-Drive® SDWC TRUSS Screw (cont.)

SDWC – Allowable Roof-to-Wall Connection Loads – DF, SP, SPF, HF

Model No.	Minor Diameter (in.)	Length (in.)	Thread Length (in.)	Allowable Loads (lb.)					
				DF/SP			SPF/HF		
				Uplift	F ₁	F ₂	Uplift	F ₁	F ₂
SDWC15600	0.152	6	5¼	615	130	225	485	115	190

1. Loads have been increased for wind and earthquake ($C_D=1.6$); no further increases allowed. Reduce when other loads govern.
2. Allowable loads are for an SDWC installed per the 'Recommended' or 'Optional' installation instructions. The SDWC is to be installed through a double 2x top plate into a minimum 2x4 truss or rafter.
3. An SDWC screw may be used in each ply of 2- or 3-ply rafters or trusses. The allowable uplift load for each screw shall be multiplied by 0.90, but may be limited by the capacity of the plate or the connection between the top plate to the framing below. SDWC screws in multi-ply assemblies must be spaced a minimum of 1½" o.c.
4. Screws are shown installed on the interior side of the wall. Installations on the exterior side of the wall are acceptable when the rafter or truss overhangs the top plates a minimum of 3½".
5. For Uplift Connection Load Path, the designer shall verify complete continuity of the uplift load path.
6. When a screw is loaded simultaneously in more than one direction, the allowable load must be evaluated using the unity equation: $(\text{Design Uplift} \div \text{Allowable Uplift}) + (\text{Design } F_1 \div \text{Allowable } F_1) + (\text{Design } F_2 \div \text{Allowable } F_2) \leq 1.0$. The three terms in the unity equation represent the possible generated force directions. The number of terms that must be considered for simultaneous loading is the sole discretion of the Designer and depends on the method of calculating wind forces and the utilization of the screws within the structural system.
7. Table loads do not apply to trusses with end-grain bearing.
8. Top plate, stud and top plate splice fastened per applicable Building Code.

Typical Roof-to-Wall Connection

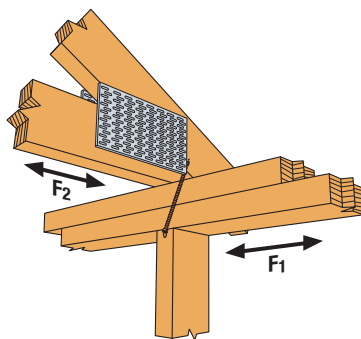

Typical SDWC Installation – Truss Aligned w/Stud
(Offset truss similar)

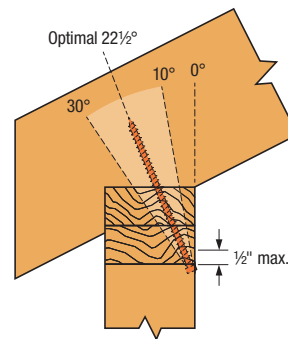

Installation Angle Limit

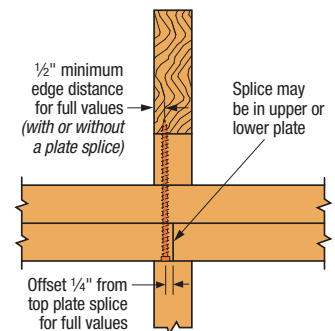

Min. Edge Distance for Top Plate Splice

Optional Roof-to-Wall Connection

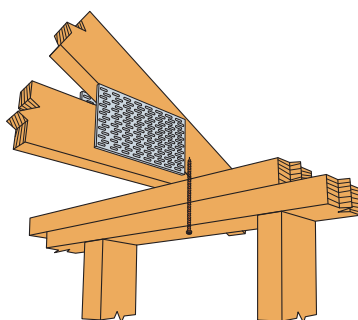

Optional SDWC Installation – Truss Offset from Stud

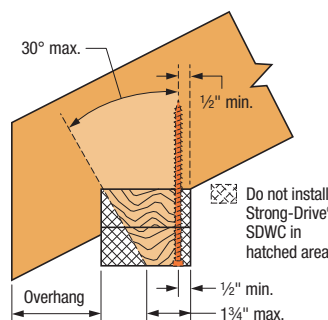

Allowable Installation Range
(Truss offset from stud only)

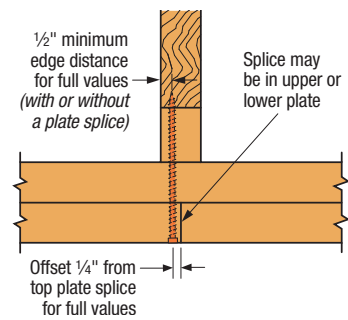

Min. Edge Distance for Top Plate Splice

Load Tables, Technical Data and Installation Instructions

Strong-Drive®

SDWC TRUSS Screw

for Truss/Rafter-to-Top Plate Connections

SDWC Truss/Rafter-to-Top Plate Connections Utilizing Two-Screw Configurations

Allowable loads for the SDWC Truss screws when installed from the underside of the top plate and from the face of the truss/rafter using a two-screw configuration per the detail configurations shown on following page.

SDWC – Allowable Loads for Truss/Rafter-to-Top Plate Two-Screw Connections

Configuration	Model No.	Minor Diameter (in.)	Length (in.)	Thread Length (in.)	Quantity Required	Allowable Loads (lbs.)					
						DF/SP			SPF/HF		
						Uplift	F ₁	F ₂	Uplift	F ₁	F ₂
A	SDWC15600	0.152	6	5¾	2	1,200	685	995	1,045	495	670
B						1,195	680	925	1,195	405	680
C						905	535	790	850	330	595
D						1,115	645	920	960	385	610

1. Loads have been increased for wind and earthquake loading ($C_D=1.6$) with no further increase allowed; reduce where other loads govern.
2. For Uplift Connection Load Path, the designer shall verify complete continuity of the uplift load path.
3. When cross-grain tension cannot be avoided, supplemental reinforcement shall be considered by the Designer.
4. The SDWC screws shall not interfere with other fasteners or truss plates. Where truss plates must be penetrated for Configuration D, a Truss Designer approval is required in accordance with ANSI/TPI 1-2007/2014, Section 7.5.3.4 and 8.9.2. To pre-drill through truss plate, use a 1/8" drill bit.
5. The metal installation guide provided with the screw is angled at 22.5° and can be used for Configurations C and D; proper installation angles for all configurations are the responsibility of the installer.
6. SDWC screws must be offset min. 1/4" from top plate splices for full values.
7. Loads assume minimum overhang of 3 1/2".
8. When a screw is loaded simultaneously in more than one direction, the allowable load must be evaluated using the unity equation: $(\text{Design Uplift} \div \text{Allowable Uplift}) + (\text{Design F}_1 \div \text{Allowable F}_1) + (\text{Design F}_2 \div \text{Allowable F}_2) \leq 1.0$. The three terms in the unity equation represent the possible generated force directions. The number of terms that must be considered for simultaneous loading is the sole discretion of the Designer and depends on the method of calculating wind forces and the utilization of the screws within the structural system.
9. An SDWC screw may be used in each ply of 2- or 3-ply rafters or trusses. The allowable uplift load for each screw shall be multiplied by 0.90, but may be limited by the capacity of the plate or the connection between the top plate to the framing below. SDWC screws in multi-ply assemblies must be spaced a minimum of 1 1/2" o.c.

Load Tables, Technical Data and Installation Instructions

Strong-Drive® SDWC TRUSS Screw for Truss/Rafter-to-Top Plate Connections (cont.)

SDWC Truss/Rafter-to-Top Plate Two-Screw Connections

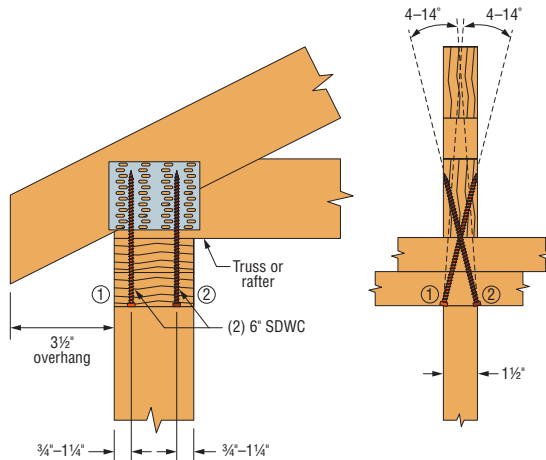

Configuration A:
Truss Aligned with Stud

Install through Top Plate into Truss/Rafter

Both screws installed at a 4°-14° angle, offset 3/4" - 1 1/4" from opposite edges of the top plate.

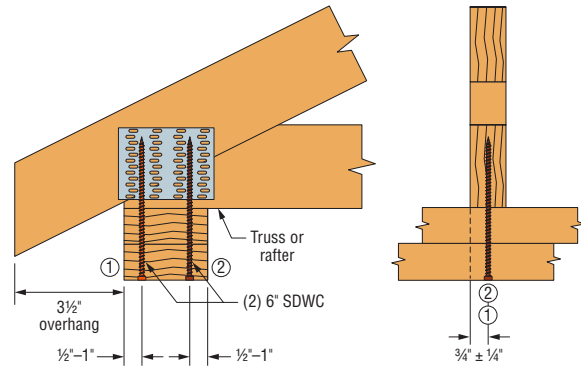

Configuration B:
Truss Offset from Stud

Install through Top Plate into Truss/Rafter

Both screws installed vertically ±5° into the center of the truss/rafter from the underside of the top plate, 1/2" - 1" from opposite edges of the top plate.

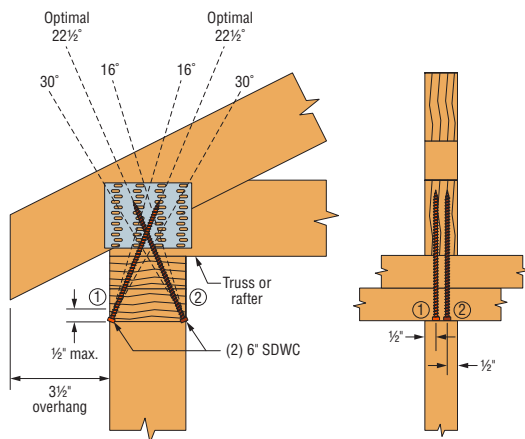

Configuration C:
Install through Top Plate into Truss/Rafter

Both screws installed at a 16°-30° angle, offset 1/2" from the opposite edges of truss/rafter. Use metal installation guide included in screw kits for optimal 22.5° installation.

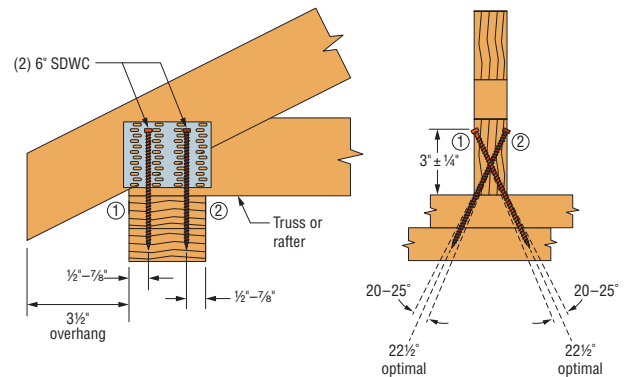

Configuration D:
Install Truss/Rafter to Top Plate

Both screws installed at a 20°-25° angle with a 1/2" - 7/8" offset from the opposite edges of top plate 3" ± 1/4" above top plate. Use metal installation guide included in screw kits for optimal 22.5° installation. To pre-drill through truss plates, use a 1/8" drill bit.

Load Tables, Technical Data and Installation Instructions

Strong-Drive® SDWC TRUSS Screw (cont.)

SDWC – Allowable Stud-to-Plate Connection Loads – DF, SP, SPF, HF

Model No.	No. of Screws Installed	Minor Diameter (in.)	Length (in.)	Thread Length (in.)	Nominal Plate Thickness (in.)	Allowable Loads (lb.)			
						DF/SP		SPF/HF	
						Uplift	F ₂	Uplift	F ₂
SDWC15450	1	0.152	4½	4¼	2x	360	215	310	153
	2					690	390	595	280
	3					1,035	585	895	420
SDWC15600	1	0.152	6	5¾	2x	450	189	310	153
	2					865	345	595	280
	3					1,295	515	895	420
SDWC15600	1	0.152	6	5¾	(2) 2x	590	177	510	152
	2					1,135	320	980	275
	3					1,700	485	1,470	415

1. Loads have been increased for wind and earthquake loading ($C_D = 1.6$) with no further increases allowed; reduce where other loads govern.
2. Allowable loads are for SDWC installed per the installation instructions.
3. The SDWC15450 is to be installed through the face of 2x stud into a single 2x bottom plate over a concrete/masonry foundation.
4. The SDWC15600 is to be installed through the face of 2x stud into a single 2 x bottom plate over a wood floor system.
5. The SDWC15600 is to be installed through the face of 2x stud into a double 2x top or bottom plate.

6. Double-top plates shall be fastened together as required by applicable code.
7. When a screw is loaded simultaneously in more than one direction, the allowable load must be evaluated using the unity equation: $(\text{Design Uplift} \div \text{Allowable Uplift}) + (\text{Design F}_1 \div \text{Allowable F}_1) + (\text{Design F}_2 \div \text{Allowable F}_2) \leq 1.0$. The three terms in the unity equation represent the possible generated force directions. The number of terms that must be considered for simultaneous loading is the sole discretion of the Designer and depends on the method of calculating wind forces and the utilization of the screws within the structural system.

Stud-to-Plate Connections

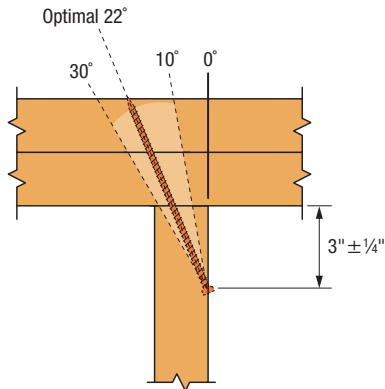

Stud-to-Top Plate Connection
(This application requires SDWC15600)

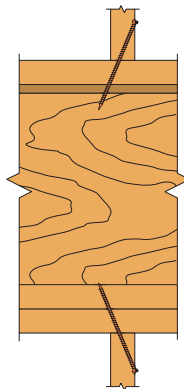

Stud-to-Bottom Plate Connection Over Wood Floor
(This application requires SDWC15600)

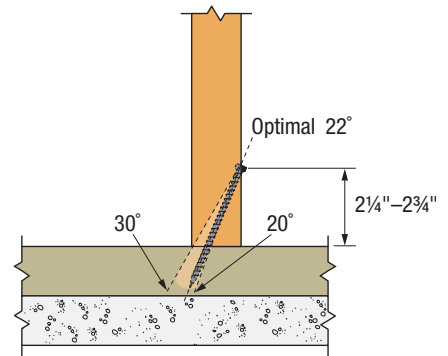

Stud-to-Bottom Plate Connection Over Concrete/Masonry Foundation
(This application requires SDWC15450)

Spacing Requirements

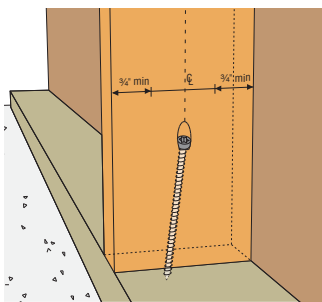

One Screw
One fastener driven in wide face of 2x4, 2x6 or 2x8; maintain minimum edge distance of ¾".

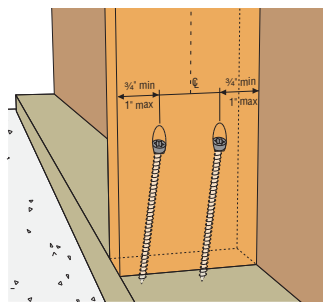

Two Screws
Two fasteners driven into same wide face of 2x4, 2x6 or 2x8. Maintain minimum edge distance of ¾" and maximum edge distance of 1" for proper spacing between fasteners.

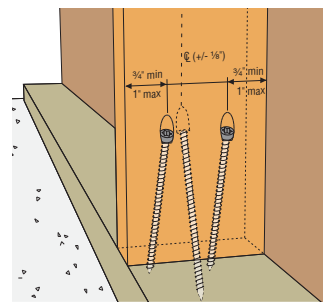

Three Screws
Two fasteners driven into same wide face of 2x4, 2x6 or 2x8. Maintain minimum edge distance of ¾" and maximum edge distance of 1" for proper spacing between fasteners.

One fastener driven within ¼" of centerline of 2x4, 2x6 or 2x8 on OPPOSITE wide face.

Load Tables, Technical Data and Installation Instructions

Strong-Drive®

SDWC TRUSS Screw

for Narrow Face of Stud-to-Plate Connections

The Strong-Drive SDWC Truss screw provides an easy-to-install, high-capacity solution for stud-to-bottom plate or stud-to-top plate(s) connections. This table provides additional allowable load information for the SDWC screws when installed through the narrow face of the stud. The allowable loads are for SDWC screws installed per the details shown on p. 346.

SDWC – Allowable Loads for Narrow Face of Stud-to-Plate Connections

Type of Connection	Model No.	Quantity Required	Minor Diameter (in.)	Length (in.)	Thread Length (in.)	Nominal Plate Thickness (in.)	Allowable Loads (lb.)			
							DF/SP		SPF/HF	
							Uplift	F2	Uplift	F2
1	SDWC15600 ¹	1	0.152	6	5¾	(2) 2x	590	170	510	145
2	SDWC15600 ²	1	0.152	6	5¾	2x	450	155	310	135
3	SDWC15450 ³	1	0.152	4½	4¼	2x	295	150	255	130

1. Where noted, loads have been increased for wind and earthquake ($C_D=1.6$). No further increase is allowed; reduce when other loads govern.

2. Where noted, the SDWC15600 is to be installed through the narrow face of 2x stud into a single 2x bottom plate over a wood floor system.

3. Where noted, the SDWC15450 is to be installed through the narrow face of 2x stud into a single 2x bottom plate over a concrete/masonry foundation.

4. Double-top plates shall be fastened together as required by applicable Code.

5. When a screw is loaded simultaneously in more than one direction, the allowable load must be evaluated using the unity equation: (Design Uplift ÷ Allowable Uplift) + (Design F1

÷ Allowable F1) + (Design F2 ÷ Allowable F2) ≤ 1.0. The three terms in the unity equation represent the possible generated force directions. The number of terms that must be considered for simultaneous loading is the sole discretion of the Designer and depends on the method of calculating wind forces and the utilization of the screws within the structural system.

6. One SDWC screw per stud maximum when installed in the narrow face of the stud. Where the SDWC screws are installed on multiple adjacent studs, the minimum spacing between screws must be 1½". The allowable uplift load for each screw shall be multiplied by 0.90, but may be limited by the capacity of the plate.

7. For Uplift Continuous Load Path, connections in the same area (i.e. truss to plate connector and plate to stud connector) must be on the same side of the wall.

Load Tables, Technical Data and Installation Instructions

Strong-Drive® SDWC TRUSS Screw for Narrow Face of Stud-to-Plate Connections (cont.)

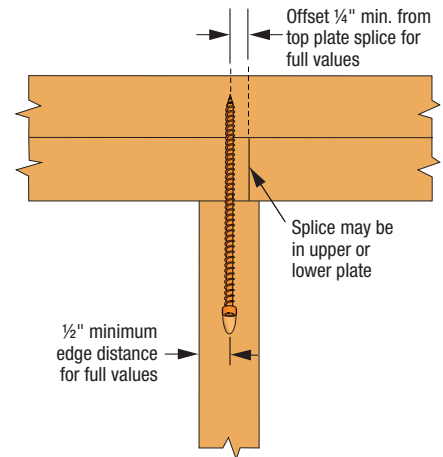
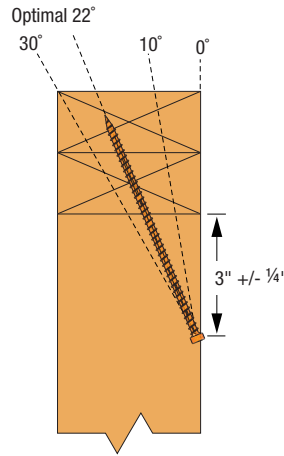
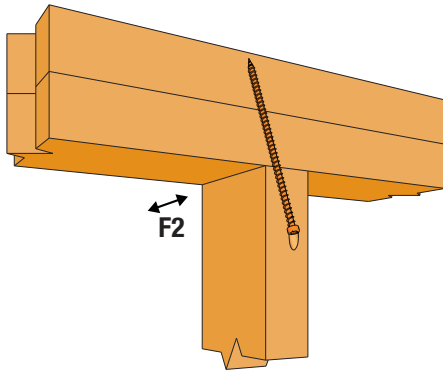

1 Narrow Face of Stud-to-Top Plate Connection
(This application requires SDWC15600)

Installation Angle Range

Min. Edge Distance and Splice Offset Requirements

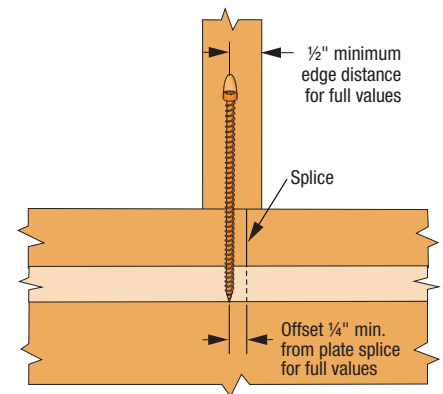
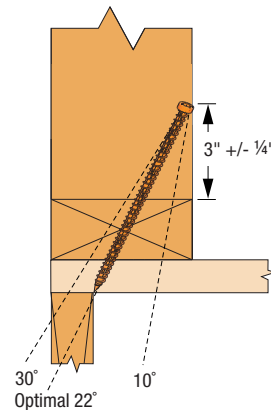
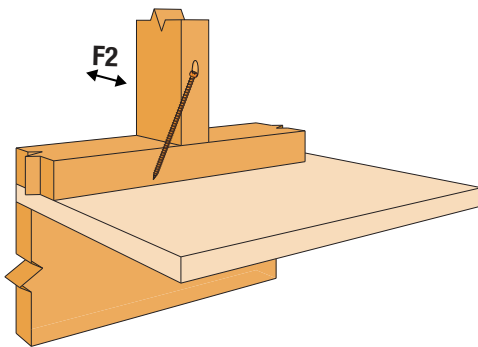

2 Narrow Face of Stud-to-Bottom Plate Connection Over Wood Floor
(SDWC15600 shown)

Installation Angle Range

Min. Edge Distance and Splice Offset Requirements

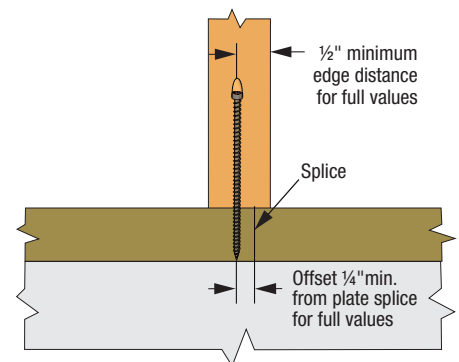
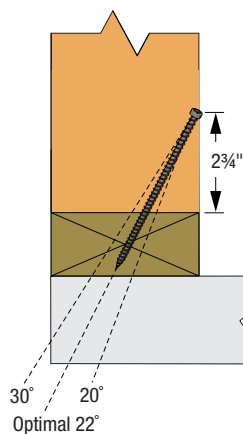
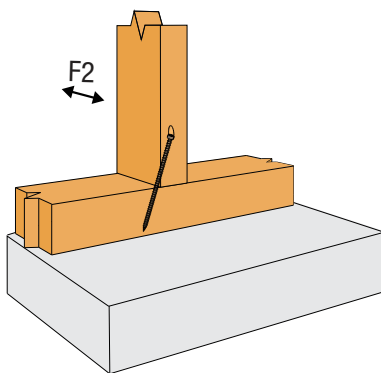

3 Narrow Face of Stud-to-Bottom Plate Connection Over Masonry/Concrete Foundation
(The application requires SDWC15450)

Installation Angle Range

Min. Edge Distance and Splice Offset Requirements

Load Tables, Technical Data and Installation Instructions

Strong-Drive® SDWC TRUSS Screw (cont.)

Continuous Load Path Considerations with the SDWC

Building codes require structures to be designed to create a continuous load path. Forces must be transferred from their point of origin to the building elements that are designed to resist them. When uplift forces act on a roof, the roof must be tied to the wall, and the wall must be tied to the foundation or wall below.

Like many common hurricane ties, the SDWC screw fastens the rafter or truss directly to the top plate of the wall below. The wall top plate alone does not offer sufficient resistance to roof uplift forces, and therefore must be tied to the studs or framing of the wall. This connection may be made with structural sheathing designed for uplift or a metal connector installed on the same side of the wall as the SDWC screw; however, the fasteners of the sheathing or connector must not interfere with the SDWC screw. The Simpson Strong-Tie® H2.5A, TSP, and MTS12 are ideal metal connectors for this application.

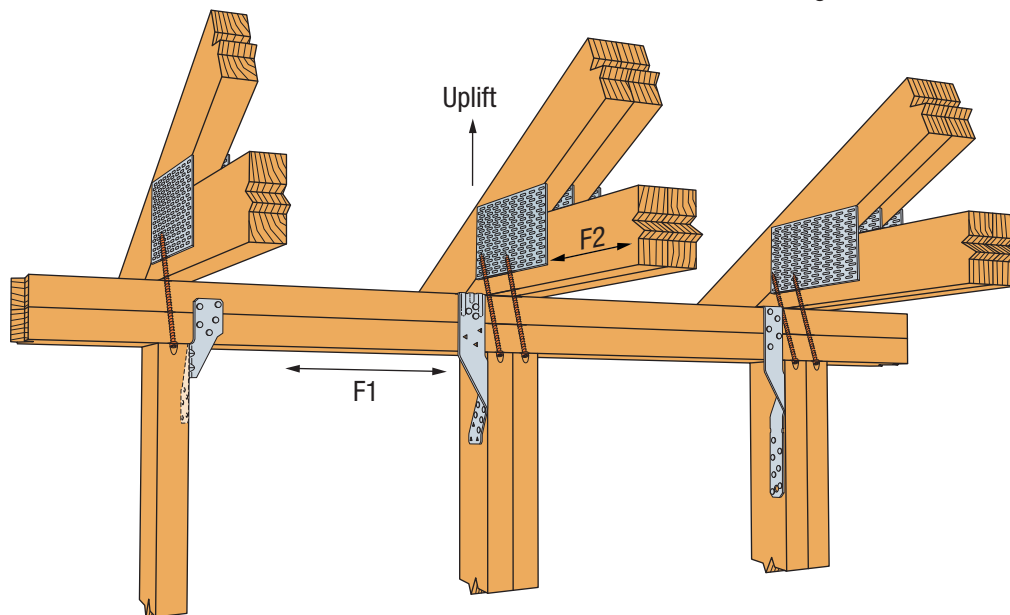
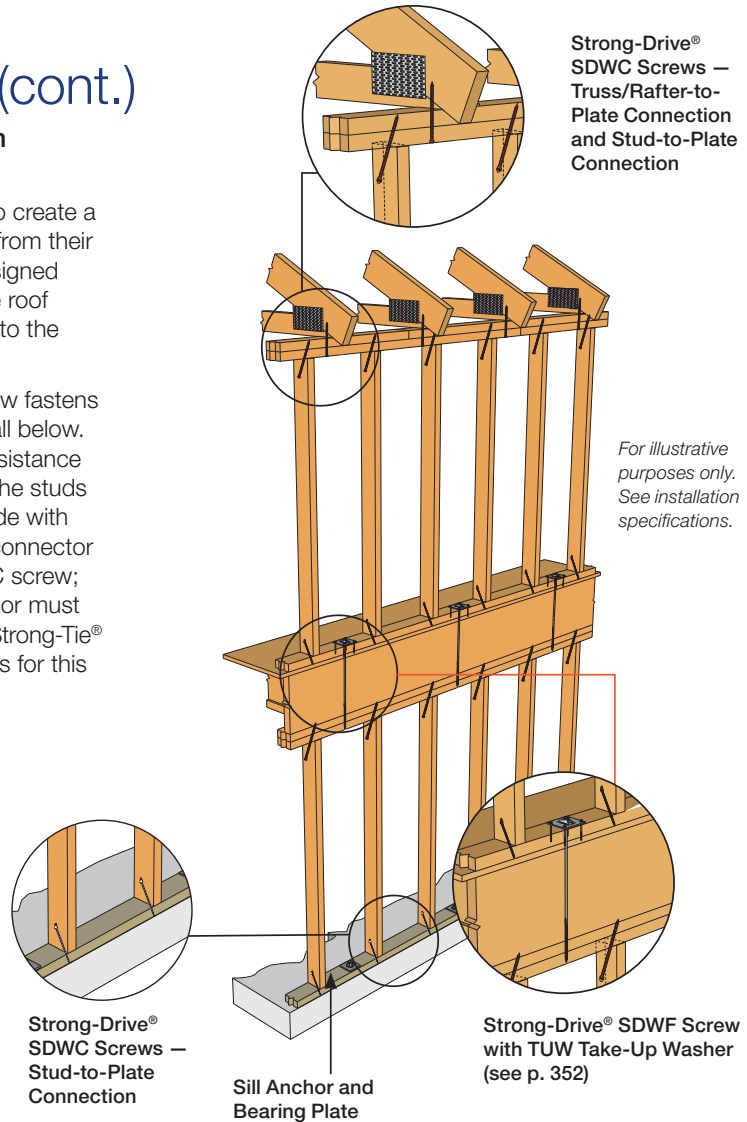

Single SDWC with H2.5A
Plate-to-Stud Connector

Double SDWC with TSP
Plate-to-Stud Connector

Double SDWC with MTS12
Plate-to-Stud Connector

Load Tables, Technical Data and Installation Instructions

Strong-Drive® SDWC TRUSS Screw (cont.)

SDWC – Allowable Shear Loads for Sole-to-Rim Connections

Size (in.)	Model No.	Nominal Sole Plate Thickness (in.)	Minimum Penetration into Rim Board (in.)	Allowable Loads (lb.)							
				2x DF/SP Rim Board		2x SPF/HF Rim Board		1 1/4" Min. LVL Rim Board		1 1/4" Min. LSL Rim Board	
				DF/SP Sole Plate	SPF/HF Sole Plate	DF/SP Sole Plate	SPF/HF Sole Plate	DF/SP Sole Plate	SPF/HF Sole Plate	DF/SP Sole Plate	SPF/HF Sole Plate
0.152 x 4.5	SDWC15450	2x	2.25	235	205	205	205	255	225	275	215
0.152 x 6	SDWC15600	2x or 3x	2.25	235	205	205	205	255	225	275	215

1. Allowable loads are based on testing per ICC-ES AC233 and are limited to parallel-to-grain loading.
2. Allowable loads are shown at the wood load duration factor of $C_D = 1.00$. Loads may be increased for load duration by the building code up to a $C_D = 1.60$.
3. Minimum spacing of the SDWC is 6" o.c., and minimum end distance is 6", and minimum edge distance is 5/8".
4. Wood structural panel up to 1 1/8" thick is permitted between the sole plate and rim board provided it is fastened to the rim board per code and the minimum penetration of the screw into the rim board is met.
5. A double 2x sole plate is permitted provided it is independently fastened per the code and the minimum screw penetration per the table is met.

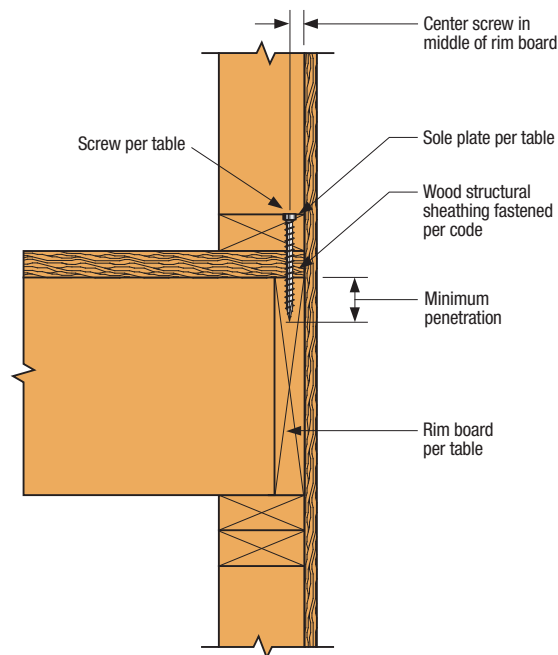

Load Tables, Technical Data and Installation Instructions

Strong-Drive® SDWC TRUSS Screw for Top-of-Wall Assemblies for SPF Lumber

SDWC Pre-Engineered Top-of-Wall Assemblies for Continuous Uplift Load Path for SPF or Better Wood Framing

The Strong-Drive® SDWC TRUSS Screw is designed to fasten roof rafters/trusses to wall plates and wall plates to studs. When used to connect rafters/trusses to top plates, a second connection from top plates to the studs below is necessary in order to maintain a continuous load path (as would be required for any connection method). This table provides allowable uplift loads for the five pre-engineered top-of-wall assemblies shown on p. 350. These assemblies have been designed and tested to provide a continuous load path from the rafter/truss to the studs in the wall below and account for any reductions that may result from top plate rotation due to eccentric loading. The continuous load path from the bottom of the stud to the supporting structure is by others.

SDWC – Allowable Uplift Load for Pre-Engineered Top-of-Wall Assemblies

Wall Assembly	Rafter/Truss Connection to Top Plates	Top Plate Connection to Studs at 16" On Center ⁴	Allowable Rafter/Truss Uplift Load (lb.)					
			2x4 SPF Framing			2x6 SPF Framing		
			Rafter/Truss Spacing			Rafter/Truss Spacing		
			12	16	24	12	16	24
A	1 – SDWC15600	1 – SDWC15600	385	485	485	385	485	485
B		2 – SDWC15600	485	485	485	485	485	485
C		1 – SDWC15600	305	410	485	305	410	485
D		1 – SDWC15600	120	160	240	120	160	240
E		WSP per Designer ³	145	195	290	105	140	210

1. Allowable loads apply to SPF (G=0.42) or better wood framing.

2. Uplift loads have been increased for wind loading ($C_w=1.6$) with no further increases allowed; reduce where other loads govern.

3. Wood structural panel (WSP) sheathing used in Wall Type E must be designed and constructed to resist uplift in accordance with the American Wood Council's 2008 or 2015 Special Design Provisions for Wind and Seismic standard.

4. As indicated in table header, studs spaced at 16" o.c. for all assemblies.

Load Tables, Technical Data and Installation Instructions

Strong-Drive® SDWC TRUSS Screw for Top-of-Wall Assemblies (cont.)

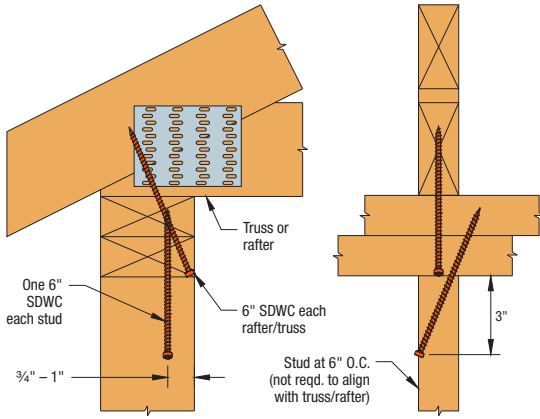

Wall Assembly A

One SDWC as Angled Stud Screw

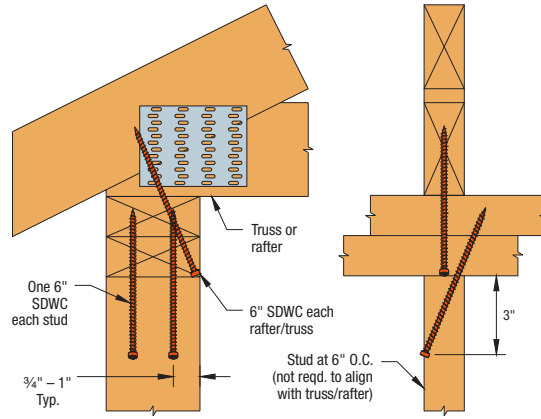

Wall Assembly B

Two SDWC as Angled Stud Screw

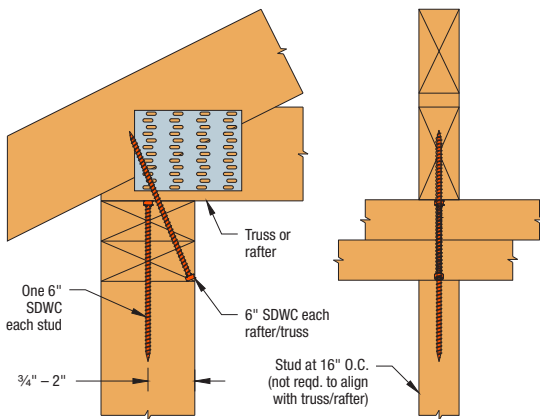

Wall Assembly C

One SDWC as Vertical Stud Screw Through Both Plates

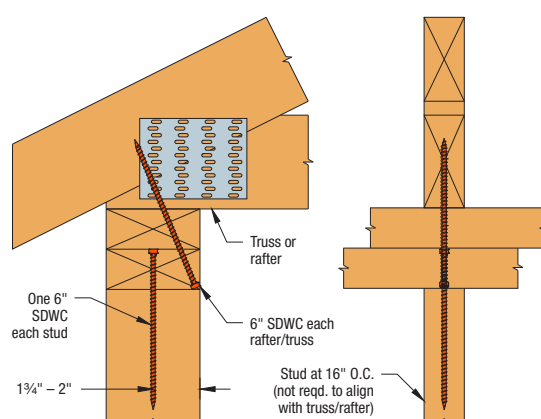

Wall Assembly D

One SDWC as Vertical Stud Screw Through Lower Plates

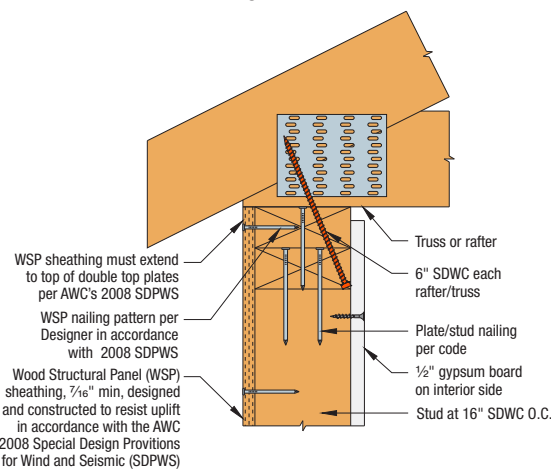

Wall Assembly E

WSP Designed for Uplift

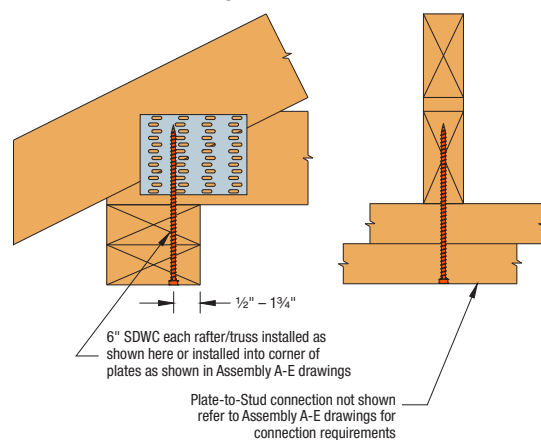

Rafter/Truss Offset from Stud

Load Tables, Technical Data and Installation Instructions

Strong-Drive® SDWC TRUSS Screw for Factory-Built Structures

The allowable uplift loads are provided for the Simpson Strong-Tie SDWC15600 wood screw installed with a 5/8" OSB bearing strip between the truss and top plate.

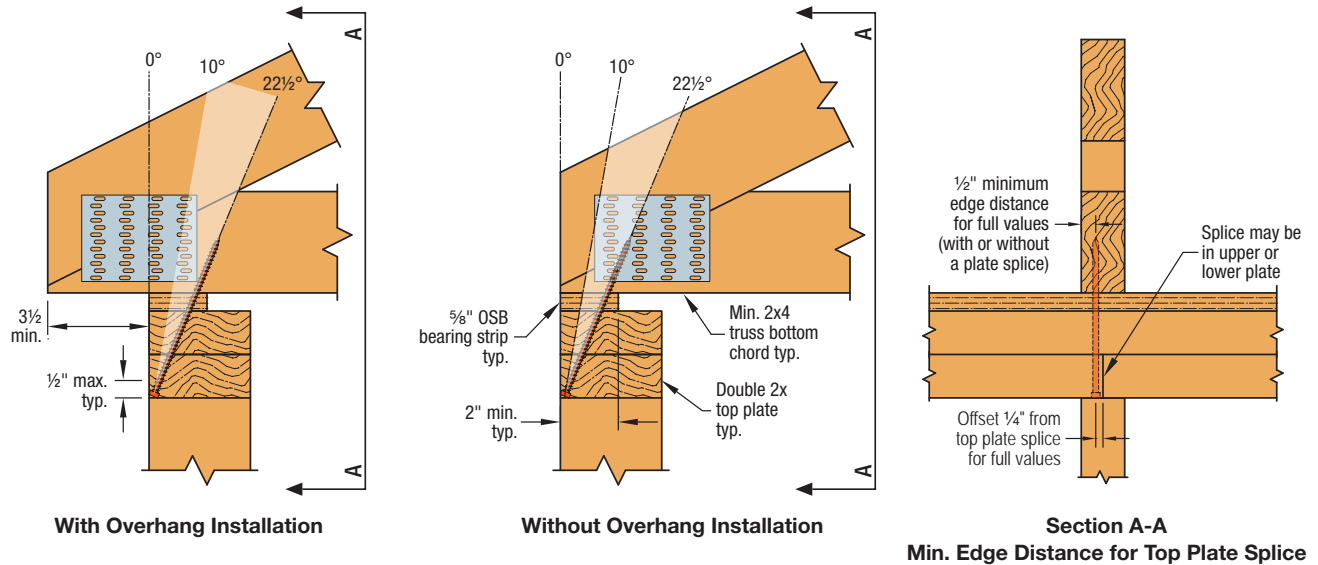

SDWC – Allowable Uplift Loads for Factory-Built Structures

Model No.	Minor Diameter (in.)	Length (in.)	Thread Length (in.)	Allowable Uplift SPF/DF/SP (lb.) (160)	
				With Overhang	Without Overhang
SDWC15600	0.152	6	5/4	415	370

1. Loads have been increased for wind or earthquake ($C_e=1.6$); no further increase allowed; reduce where other loads govern.
2. Allowable loads apply to Spruce-Pine-Fir, Hem-Fir, Douglas Fir-Larch, and Southern Pine.
3. Allowable loads are for an SDWC installed per the "With Overhang" or "Without Overhang" installation details.
4. SDWC must be installed on the exterior side of the wall.
5. SDWC must be installed at an angle between 10° and 22½°. Guide provided with screws is at 22½°.
6. For Uplift Continuous Load Path, top plate to stud connections must be located on the exterior side of the wall.
7. Table loads do not apply to trusses with end-grain bearing.
8. Top plate, stud, and top plate splice fastened per applicable building code.

Load Tables, Technical Data and Installation Instructions

Strong-Drive® SDWF FLOOR-TO-FLOOR Screw

Wind-Uplift Restraint Connections

Features:

- The take-up washer (TUV) allows for shrinkage compensation ensuring a tight connection even after initial shrinkage and settlement occur
- One screw length can be used for multiple floor depths (refer to chart to select appropriate screw size), reducing the need for many screw lengths

Codes/Standards: ICC-ES ESR-3046 (SDWF), ICC-ES ESR-2320 (TUV), State of Florida FL9589, FL1007 (TUV)

For more information, see p. 95

U.S. Patent: 8,276,323

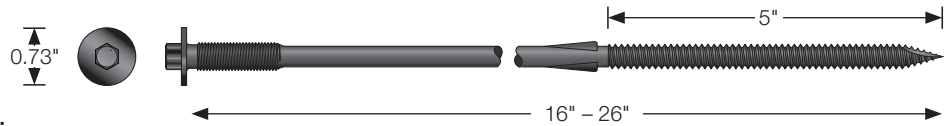

Additional Installation Considerations:

- To choose the appropriate SDWF screw length, see top table on next page
- The SDWF screw installs best with a high torque, ½" variable speed drill (at least 18V if cordless) with a ⅝" hex-head driver (hex driver provided)
- See details for minimum edge/end fastener distances

Installation Instructions for the Strong-Drive SDWF STRUCTURAL Screw and Take-Up Washer (TUV)

To Install:

- a) Drive the SDWF screw vertically ($90^\circ \pm 2^\circ$) into the center of the upper-wall bottom plate.
 - b) Once the SDWF screw has passed through upper-wall bottom plate and floor sheathing, make sure the screw is still vertical ($90^\circ \pm 2^\circ$) prior to driving it into lower-wall double top plate. Adjust if necessary.
 - c) Continue driving the SDWF screw until the head is a minimum of 2" above the upper-wall bottom plate.
- Slide the TUV (provided) over the SDWF screw head and center using locator tab as a reference. Orient locator tab so that it points toward the outside of the wall.

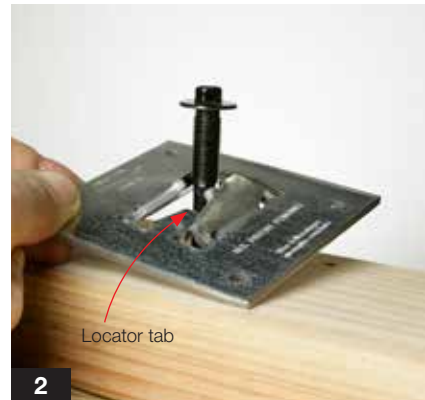

- Secure the TUV to the upper-wall bottom plate with (4) #9 x 2½" Simpson Strong-Tie® Strong-Drive SD screws (provided).
- Continue driving the SDWF screw until the washer head contacts the threaded TUV tabs and bends them until they engage the shank of the SDWF screw directly under the head. Do not overdrive.
- Check to ensure the proper engagement of the TUV tabs to the SDWF screw shank using the screw depth guide (provided). The measured gap shall be no greater than ⅜" and no less than ⅝".



Load Tables, Technical Data and Installation Instructions

Strong-Drive® SDWF FLOOR-TO-FLOOR Screw Installation Conditions

Product Information and Withdrawal Loads

Model No	Size (in.)	Thread Length (in.)	Joist Depth Below (in.)				Allowable Withdrawal per Thread Penetration (lb./in.)		
			Single Bottom Plate		Double Bottom Plate		SP	DF	SPF
			Min.	Max.	Min.	Max.			
SDWF2716-TUW	0.27 x 16	5	8½	10½	6¾	9	295	250	180
SDWF2720-TUW	0.27 x 20	5	12½	14½	10¾	13			
SDWF2724-TUW	0.27 x 24	5	16½	18½	14¾	17			
SDWF2726-TUW	0.27 x 26	5	18½	20½	16¾	19			

1. Allowable loads are for $C_D=1.0$ and may be increased for load duration up to $C_D = 1.6$.
2. Joist depth listed based on the ¾" subfloor and 3" of thread penetration into double top plates.

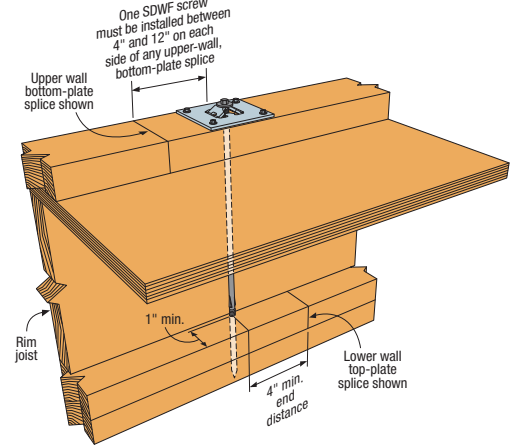

Typical SDWF and TUW Installation

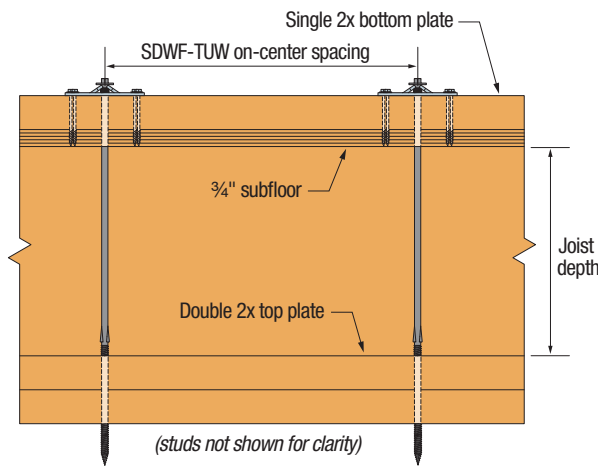

SDWF-TUW Assembly

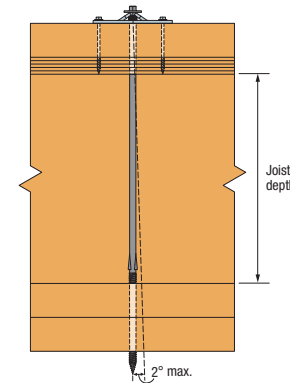

Typical SDWF Angle Limit Installation

SDWF-TUW Floor-to-Floor Screw – On Center Spacing for Uniform Uplift Loads

Bottom Plate	Maximum SDWF Screw Spacing (in.) Along Wall Bottom Plate for Wind Uplift										
	Interstory Unit Wind Uplift, Lb. per Lineal Foot (plf)										
Single 2x4	100 plf	150 plf	200 plf	250 plf	300 plf	350 plf	400 plf	450 plf	500 plf	550 plf	600 plf
SP	46	40	36	34	30	28	26	24	24	22	22
DF	48	42	38	34	32	30	30	26	24	22	20
SPF	46	40	36	34	32	30	26	22	20	18	16
Single 2x6	100 plf	150 plf	200 plf	250 plf	300 plf	350 plf	400 plf	450 plf	500 plf	550 plf	600 plf
SP	56	48	44	40	38	36	34	34	32	30	28
DF	56	48	44	40	38	34	30	26	24	22	20
SPF	52	46	42	38	34	30	26	22	20	18	16

1. Spacing listed based on lesser of: single bottom plate bending allowable load, single bottom plate deflection limited to spacing/240 and ¼" max, screw allowable withdrawal load, and take-up washer allowable load.
2. Withdrawal load is based on a $C_D = 1.6$ and minimum 3" penetration into lower wall double top plates.
3. Stud-to-plate connections are required to complete the load path. These connections shall not exceed the lesser of 48" o.c. or SDWF spacing.
4. Spacing values listed for SP lumber consider new base values adopted by AWC on June 1, 2012.

Load Tables, Technical Data and Installation Instructions

Strong-Drive® SDWF FLOOR-TO-FLOOR Screw Installation Conditions (cont.)

Concentrated Uplift Loads

Model No.	Single SDWF-TUW				Double SDWF-TUW			
	Allowable Tension Load (lb.)			Deflection at Highest Allowable Load (in.)	Allowable Tension Load (lb.)			Deflection at Highest Allowable Load (in.)
	SP	DF	SPF		SP	DF	SPF	
SDWF2716-TUW	1,410	1,200	865	0.095	2,270	2,125	1,730	0.142
SDWF2720-TUW								
SDWF2724-TUW								
SDWF2726-TUW								

1. Allowable loads listed include a wood load duration factor of $C_D = 1.6$ for wind or earthquake loading with no further increase allowed; reduce when other loads govern.
2. Single and double SDWF-TUW applications listed are for concentrated load uplift restraint conditions (i.e. end of header, at girders, or at the end of shearwalls).

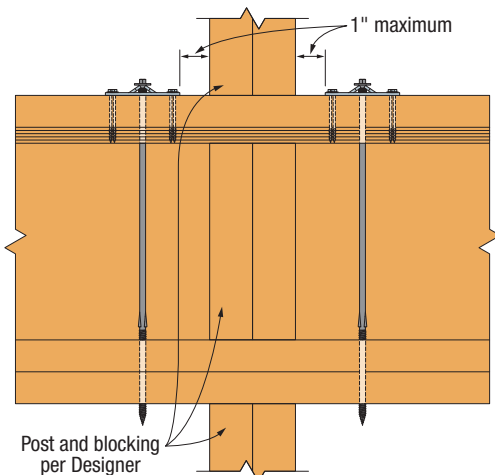

Double SDWF-TUW Concentrated Load Restraint Detail at Continuous Wall

(Single SDWF-TUW similar)

Note: Stud-to-plate connections are required to complete the load path and are the responsibility of the Designer. SDWF not to replace holdowns in shearwall applications.

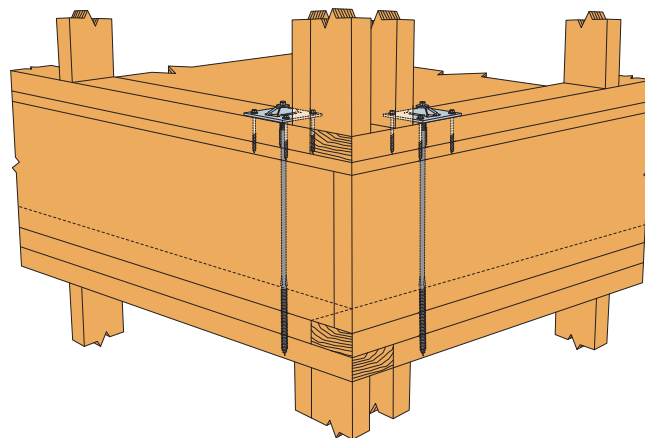

Perspective View of Corner Conditions with Double SDWF-TUW

(Single SDWF-TUW similar)



Web App Enables Designers to Calculate Wood Shrinkage Easier

The Simpson Strong-Tie Wood Shrinkage Calculator is a quick and easy Web App to estimate the amount of shrinkage the structure may experience as the wood member loses moisture content after it is framed and in service. The calculator estimates the shrinkage of each wood member in the wall and floor framing assembly and provides a graphical summary to help understand the global impact of shrinkage of individual elements in the wall system. To access this free application, visit strongtie.com/shrinkcalc.

Load Tables, Technical Data and Installation Instructions

Strong-Drive® SDWF FLOOR-TO-FLOOR Screw (cont.)

Alternate Floor Joist Depths

The SDWF Floor-to-Floor screw is available in lengths of 16", 20", 24" and 26". These lengths allow for full 3" thread penetration into the double top plates to accommodate a wide range of floor depths. The table below provides allowable withdrawal loads and SDWF spacing for common floor depths which results in reduced thread penetration. For additional floor depths, refer to engineering eetter L-F-SDWFALTHT, available on strongtie.com.

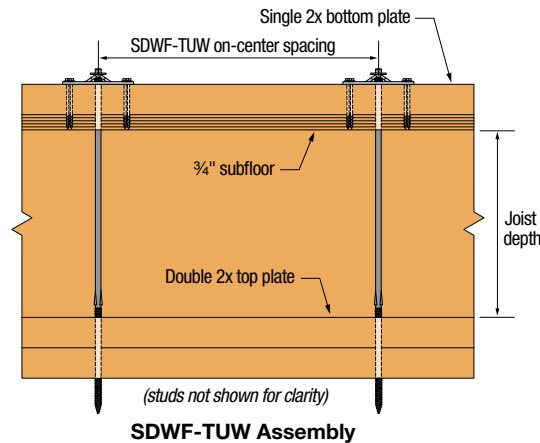

SDWF-TUW – Floor-to-Floor Screw On-Center Spacing for Uniform Uplift Loads^{1,3}

Joist Depth (in.)	Model No.	Wall Plate Species	Withdrawal ² per SDWF (lb.)	Maximum SDWF Screw Spacing (in.) Along Wall Bottom Plate for Wind Uplift											
				Interstory Unit Wind Uplift (lb. per Lineal Foot)											
				100	150	200	250	300	350	400	450	500	550	600	
11 1/4"	SDWF2716-TUW	Single 2x4 Bottom Plate													
		SP	740	46	40	36	34	30	25	22	20	18	16	15	
		DF	630	48	42	38	30	25	22	19	17	15	14	13	
		SPF	450	46	36	27	22	18	16	14	12	11	10	9	
		Single 2x6 Bottom Plate													
		SP	740	56	48	44	36	30	25	22	20	18	16	15	
11 7/8"	SDWF2720-TUW	Single 2x4 Bottom Plate													
		SP	1,140	46	40	36	34	30	30	26	24	24	22	22	
		DF	965	48	42	38	34	32	30	29	26	23	21	19	
		SPF	695	46	40	36	33	28	24	21	19	17	15	14	
		Single 2x6 Bottom Plate													
		SP	1,140	56	48	44	40	38	36	34	30	27	25	23	
16"	SDWF2724-TUW	Single 2x4 Bottom Plate													
		SP	1,195	46	40	36	34	30	30	26	24	24	22	22	
		DF	1,015	48	42	38	34	32	30	30	26	24	22	20	
		SPF	730	46	40	36	34	29	25	22	19	18	16	15	
		Single 2x6 Bottom Plate													
		SP	1,195	56	48	44	40	38	36	34	32	29	26	24	

1. Spacing listed based on lesser of: single bottom plate bending allowable load, single bottom plate deflection limited to spacing/240 and 1/4" max, screw allowable withdrawal load, and take-up washer allowable load.

2. Withdrawal load is based on a C₀ = 1.6.

3. Stud-to-plate connections are required to complete the load path. These

connections shall not exceed the lesser of 48" o.c. or SDWF spacing.

4. Spacing values listed for SP lumber consider new base values adopted by AWC on June 1, 2012.

5. Applications with 11 1/4" joist depths primarily connect to the upper 2x of the double top plate-to-stud; connections securing the double top plate should engage the upper 2x.

Load Tables, Technical Data and Installation Instructions

Strong-Drive® SDW TRUSS-PLY and EWP-PLY Screws

Truss-Ply Fastening, Multi-Ply Wood Members, Engineered-Lumber Products and Solid-Sawn Lumber

Codes/Standards: IAPMO-UES ER-192, City of L.A. RR25906, State of Florida FL13975

For More Product Information, see pp. 93–94

U.S. Patents: 5,897,280; 7,101,133 and 6,109,850

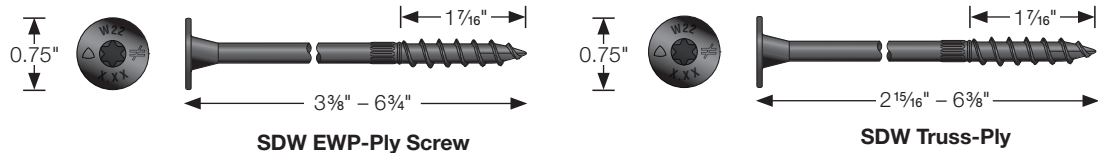

Installation:

- SDW screws install best with a low-speed 1/2" drill motor and a T-40 6-lobe bit. The matched bit included with the screws is recommended for best results.
- Pre-drilling is typically not required. SDW screws may be installed through metal truss plates as approved by the Truss Designer, provided the requirements of ANSI/TPI 1-2007 Section 8.9.2 are met (pre-drilling required through the plate using a maximum of 5/32" bit).
- Screw heads that are countersunk flush to the wood surface are acceptable if the screw has not spun out.
- Individual screw locations may be adjusted up to 3" to avoid conflicts with other hardware or to avoid lumber defects.

Notes to the Designer:

1. Allowable loads are based on testing per ICC-ES AC233. Maximum allowable withdrawal load for DF/SP/SCL is 200 lb. and for SPF/HF withdrawal is 150 lb. where the entire thread length is engaged into the main member.
2. Allowable loads in tables are shown at the load duration factor of $C_D = 1.00$ and shall be multiplied by all applicable adjustment factors per the NDS. Loads may be increased for load duration per the building code up to a $C_D = 1.6$.
3. Minimum fastener spacing requirements: 6" end distance, 1 1/16" edge distance, 5/8" between staggered rows of fasteners, 4" between non-staggered rows of fasteners and 6" between fasteners in a row. Note exceptions in the application drawing at the top of p. 357.
4. Maximum fastener spacing is recommended not to exceed 24" on-center except as approved by a qualified Designer.
5. Structural composite lumber (SCL = LVL, PSL or LSL) loads assume an equivalent Specific Gravity of 0.50 or higher for fastener shear in the wide face (unless otherwise noted).
6. Tabular loads in this document are based on the capacity of the Simpson Strong-Tie® SDW fasteners. The capacity of the multi-ply assembly must be checked by a qualified Designer.
7. For a top-loaded, solid sawn 2x, multi-ply assembly that is evenly loaded across the entire assembly width, the recommended fastener detail is two rows of SDW screws where the spacing between fasteners in a row is 32". For a top-loaded, SCL (1 3/4") multi-ply assembly that is evenly loaded across the entire assembly width, the recommended spacing between SDW screws in a row is 24" o.c.; use two rows for up to 18" deep members and three rows for members deeper than 18".

SDW TRUSS-PLY – Allowable Shear Loads – DF, SP, SPF, HF Lumber and 2x Truss Loaded on Head Side

Assembly	Model No.	Nominal Screw Length (in.)	Thread Length (in.)	Nominal Side Member Thickness (in.)	Main Member Penetration ¹ (in.)	DF/SP Allowable Shear (lb.)	SPF/HF Allowable Shear (lb.)
2-ply 2x/truss	SDW22300	2 15/16	1 7/16	1 1/2	1 3/8	325	255
3-ply 2x/truss desert	SDW22438	4 3/8	1 7/16	1 1/2	2 7/8	400	325
3-ply 2x/truss	SDW22458	4 3/8	1 7/16	1 1/2	2 7/8	400	325
4-ply 2x/truss desert	SDW22600	6	1 7/16	1 1/2	4 1/2	400	340
4-ply 2x/truss	SDW22638	6 3/8	1 7/16	1 1/2	4 1/2	400	340

1. For minimum penetration into main (outermost) member of 1 1/8", use 235 lb. for DF/SP and 210 lb. for SPF/HF.

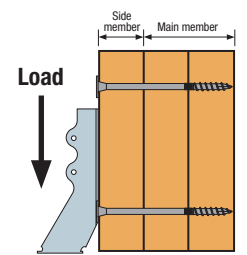

Loaded on Head Side

(3-ply assembly shown – other configurations similar)

SDW TRUSS-PLY – Allowable Shear Loads – DF, SP, SPF, HF Lumber and 2x Truss Loaded on Point Side

Assembly	Model No.	Nominal Screw Length (in.)	Thread Length (in.)	Nominal Side Member Thickness (in.)	Main Member Penetration ¹ (in.)	DF/SP Allowable Shear (lb.)	SPF/HF Allowable Shear (lb.)
2-ply 2x/truss	SDW22300	2 15/16	1 7/16	1 1/2	1 3/8	325	255
3-ply 2x/truss desert	SDW22438	4 3/8	1 7/16	3	1 3/8	275	255
3-ply 2x/truss	SDW22458	4 3/8	1 7/16	3	1 3/8	275	255
4-ply 2x/truss desert	SDW22600	6	1 7/16	4 1/2	1 3/8	275	255
4-ply 2x/truss	SDW22638	6 3/8	1 7/16	4 1/2	1 3/8	275	255

1. For minimum penetration into main member of 1 1/8", use 235 lb. for DF/SP and 210 lb. for SPF/HF.

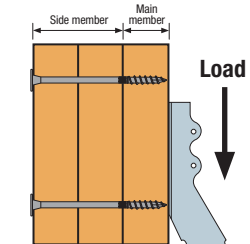

Loaded on Point Side

(3-ply assembly shown – other configurations similar)

Load Tables, Technical Data and Installation Instructions

Strong-Drive® SDW TRUSS-PLY and EWP-PLY Screws (cont.)



Lumber Fastening in Dry Climates

The highlighted regions on this map may experience drier conditions which can result in reduced lumber thickness (scant lumber) due to wood shrinkage. To help ensure optimum thread penetration into the main (outermost) member without excessive protrusion, Simpson Strong-Tie offers the 4 3/8" and 6" lengths of the SDW screw, which are sized for the thinner members common in these "desert" climates. It is the responsibility of the Truss Manufacturer or contractor/installer to determine the appropriate fastener length for any given application. See tables and footnotes for minimum required penetration.

SDW EWP-PLY – Allowable Shear Loads – LVL, PSL and LSL Loaded on Head Side

Assembly	Model No.	Nominal Screw Length (in.)	Thread Length (in.)	Nominal Side Member Thickness (in.)	Main Member Penetration ¹ (in.)	Equivalent Specific Gravity 0.50 Allowable Shear (lb.)	Equivalent Specific Gravity 0.42 Allowable Shear (lb.)
2-ply 1 3/4" SCL	SDW22338	3 3/8	1 9/16	1 3/4	1 5/8	400	255
3-ply 1 3/4" SCL	SDW22500	5	1 9/16	1 3/4	3 1/4	400	325
4-ply 1 3/4" SCL	SDW22634	6 3/4	1 9/16	1 3/4	5	400	385
2-ply 3 1/2" SCL	SDW22634	6 3/4	1 9/16	3 1/2	3 1/4	400	—

1. For minimum penetration into main (outermost) member of 1 1/2", use 300 lb.

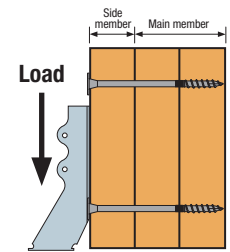

Loaded on Head Side
(3-ply assembly shown – other configurations similar)

SDW EWP-PLY – Allowable Shear Loads – LVL, PSL and LSL Loaded on Point Side

Assembly	Model No.	Nominal Screw Length (in.)	Thread Length (in.)	Nominal Side Member Thickness (in.)	Main Member Penetration ¹ (in.)	Equivalent Specific Gravity 0.50 Allowable Shear (lb.)	Equivalent Specific Gravity 0.42 Allowable Shear (lb.)
2-ply 1 3/4" SCL	SDW22338	3 3/8	1 9/16	1 3/4	1 5/8	400	255
3-ply 1 3/4" SCL	SDW22500	5	1 9/16	3 1/2	1 1/2	300	255
4-ply 1 3/4" SCL	SDW22634	6 3/4	1 9/16	5 1/4	1 1/2	300	255
2-ply 3 1/2" SCL	SDW22634	6 3/4	1 9/16	3 1/2	3 1/4	400	—

1. For minimum penetration into main member of 1 1/2", use 300 lb.

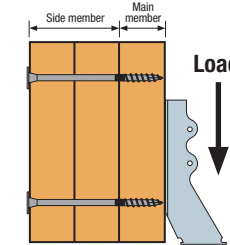

Loaded on Point Side
(3-ply assembly shown – other configurations similar)

SDW EWP-PLY – Allowable Shear Loads – Two-Ply 3x2/4x2 Parallel-Chord Trusses Loaded on Either Side

Assembly	Model No.	Nominal Screw Length (in.)	DF/SP Allowable Shear (lb.)	SPF/HF Allowable Shear (lb.)
2-ply 3x2 PCT	SDW22500	5	280	200
2-ply 4x2 PCT	SDW22634	6 3/4	280	200

- To transfer uniform or concentrated loads applied to simply supported spans on assembly top chord:
 - Space screws as required to transfer half the load into the supporting truss.
 - Minimum screw spacing shall be 4" o.c.
- To transfer concentrated loads applied to simply supported spans on an assembly top chord or vertical web:
 - Concentrated loads must be applied at a panel point.
 - Screws to be installed within 12" of the concentrated load on top-chord assembly
- Gap between the trusses shall not exceed 1/8".
- Floor sheathing shall be screwed or nailed to each top-chord ply. (Fastener spacing per the applicable Code requirements, or 12" o.c.)
- SDW screws shall not be installed in areas where lumber wane exceeds 1/4".
- Hangers on skewed girders:
 - Hanger loads not exceeding 34" o.c. on a skewed girder (resulting from uniformly spaced joists up to 24" o.c.) may be converted to a uniform load.
 - For girders with hanger load spacing in excess of 34" o.c. the loads shall be considered as concentrated loads at the applicable locations.
- Other configurations acceptable when approved by Truss Designer.

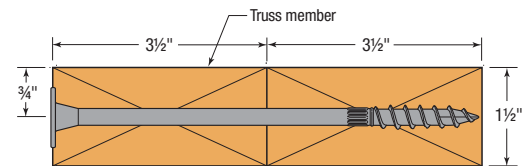

SDW Screw Position in 2-Ply 4x2 Truss

(2-ply 3x2 similar)

Concentrated Load

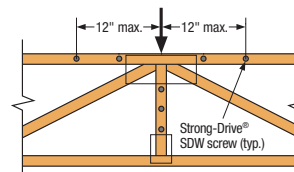

Uniform Load

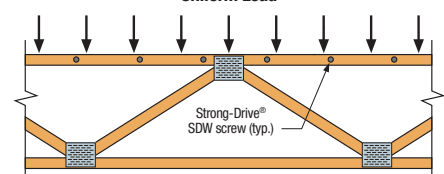

Load Tables, Technical Data and Installation Instructions

Strong-Drive®

SDW TRUSS-PLY and EWP-PLY Screws (cont.)

SDW TRUSS-PLY – Allowable Uniform Load (plf) Applied to Either Outside Member – Side-loaded Multi-Ply Assemblies

Multiple Members		Nominal Screw Length (in.)	Loaded Side	DF/SP						SPF/HF					
				12" o.c.		16" o.c.		24" o.c.		12" o.c.		16" o.c.		24" o.c.	
Assembly	Components			2 Rows	3 Rows	2 Rows	3 Rows	2 Rows	3 Rows	2 Rows	3 Rows	2 Rows	3 Rows	2 Rows	3 Rows
A-W	2-ply 2x/Truss	2 15/16	Either	1,300	1,950	975	1,465	650	975	1,020	1,530	765	1,150	510	765
B-W	3-ply 2x/Truss	4 3/8 or 4 5/8	Head	1,200	1,800	900	1,350	600	900	975	1,465	730	1,095	490	730
			Point	825	1,240	620	930	415	620	765	1,150	575	860	385	575
C-W	4-ply 2x/Truss	6 or 6 3/4	Head	1,065	1,600	800	1,200	535	800	905	1,360	680	1,020	455	680
			Point	735	1,100	550	825	365	550	680	1,020	510	765	340	510

- Each ply is assumed to carry same proportion of load.
- Loads may be applied to the head side and point side concurrently provided neither published allowable load is exceeded. (Example: a 3-ply DF assembly with a head side load of 1,300 plf and point side load of 900 plf may be fastened together with 3 rows of SDW at 16" o.c. between fasteners in a row.)
- When hangers are installed on point side, hanger face fasteners shall be a minimum of 3" long.
- Tables are based on Main Member Penetration as noted on pp. 356– 357.
- Hanger load spacing on the multi-ply assembly should not exceed 24" o.c. Exception: On a skewed girder, hanger loads up to 34" o.c. (resulting from joists uniformly spaced up to 24" o.c.) may be converted to a uniform load.

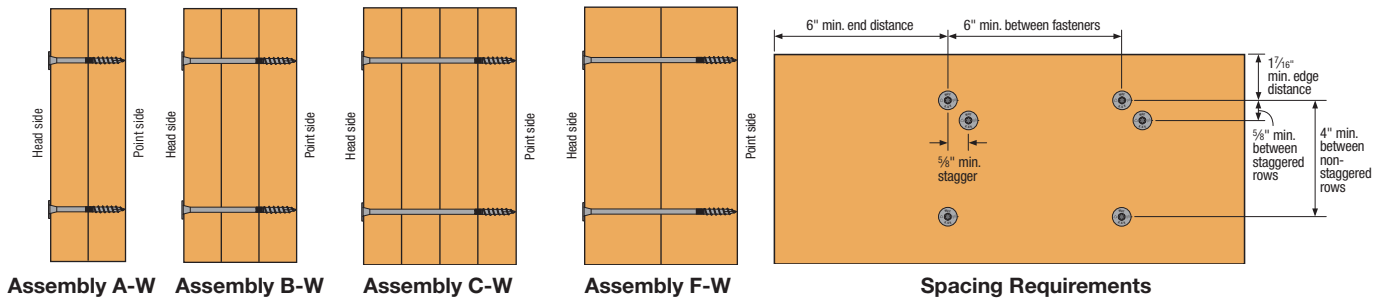

SDW EWP-PLY – Allowable Uniform Load (plf) Applied to Either Outside Member – Side-loaded Multi-Ply LVL, PSL, and LSL Assemblies

Multiple Members		Nominal Screw Length (in.)	Loaded Side	12" o.c.		16" o.c.		24" o.c.	
Assembly	Components			2 Rows	3 Rows	2 Rows	3 Rows	2 Rows	3 Rows
A-W	2-ply SCL	3 3/8	Either	1,600	2,400	1,200	1,800	800	1,200
B-W	3-ply SCL	5	Head	1,200	1,800	900	1,350	600	900
			Point	900	1,350	675	1,015	450	675
C-W	4-ply SCL	6 3/4	Head	1,065	1,600	800	1,200	535	800
			Point	800	1,200	600	900	400	600
F-W	2-ply 3 1/2" SCL	6 3/4	Either	1,600	2,400	1,200	1,800	800	1,200

- Each ply is assumed to carry same proportion of load. Loads may be applied to the head side and point side concurrently provided neither published allowable load is exceeded. (Example: a 3-ply assembly with a head side load of 1,300 plf and point side load of 1,000 plf may be fastened together with 3 rows of SDW at 16" o.c. between fasteners in a row.)
- When hangers are installed on point side, hanger face fasteners shall be a minimum of 3" long.
- Tables are based on main member penetration as noted in single-fastener load tables.

Load Tables, Technical Data and Installation Instructions

Strong-Drive® SDW TRUSS-PLY and EWP-PLY Screws (cont.)

Allowable Loads for Side-Loaded Multi-Ply Beam Assemblies per Screw

For side-loaded assemblies of structural composite lumber or sawn lumber, allowable loads in a single fastener format can be calculated from the information on pp. 356 and 357. See the figures on pp. 356 and 357 for side-load terminology. Assembly descriptions are on p. 358. The figure here is for fastener spacing relative to the side load.

As an example calculation, a three-ply beam or truss is to be fastened where the plies are of the same material and vertically-screw-laminated. The beam or truss is loaded on one face with a 2,400 lb. point load via a face-mount hanger. It is assumed that the face ply carries one-third of the load (800 lb.), and the remaining two-thirds of the load is transferred to the next two plies via the fasteners. The calculation for the allowable load applied to the outside ply of a multi-ply beam or truss is:

$$P_{allow} = Z \left(\frac{n}{n-1} \right) \quad \text{Equation 1}$$

P_{allow} = allowable load that can be applied to the outside of the multi-ply truss or beam per fastener

Z = allowable shear per fastener in SCL or lumber

n = number of plies

For the SDW EWP-Ply screw assembling SCL and the SDW Truss-Ply screw assembling sawn lumber or lumber trusses, the Equation 1 calculation provides the loads shown on p. 360.

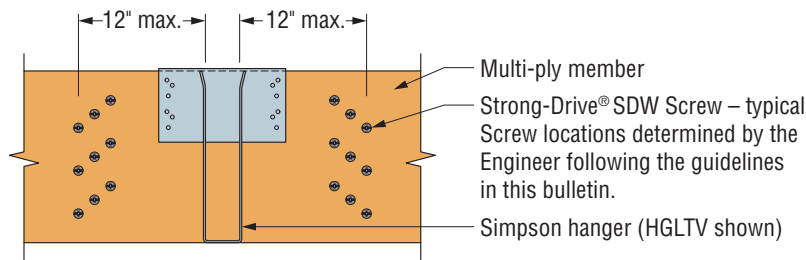

Maximum Fastener Spacing from Point Load

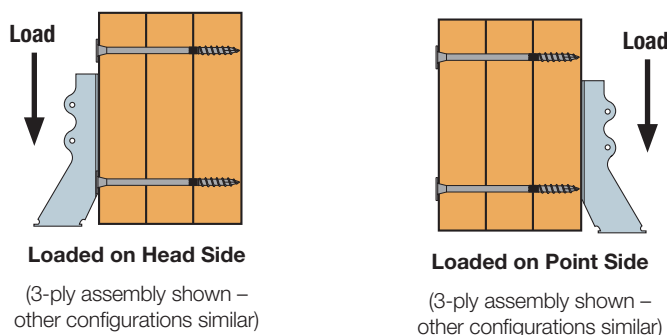

Load Applied to Outside Multi-Ply Beam

Load Tables, Technical Data and Installation Instructions

Strong-Drive® SDW TRUSS-PLY and EWP-PLY Screws (cont.)

SDW EWP-PLY – Allowable Loads for Side-Loaded Multi-Ply SCL Assemblies

Assembly Illustration	SCL Components (Plies-thickness, in.)	Model No.	Nominal Screw Length (in.)	Allowable Load for Side-Loaded Multi-Ply Truss or Beam per Screw (P_{allow} lb.)	
				Head Side	Point Side
A-W	(2) 1 ¼	SDW22338	3 ¾	800	800
B-W	(3) 1 ¼	SDW22500	5	600	450
C-W	(4) 1 ¼	SDW22634	6 ¾	533	400
F-W	(2) 3 ½	SDW22634	6 ¾	800	800

1. Loads based on equivalent specific gravity of 0.50.
2. Allowable loads include a load duration factor of $C_D = 1.00$ and may be increased up to $C_D = 1.60$ per the building code when applicable.
3. SDW EWP-Ply allowable shear loads are from p. 357.
4. Notes to the Designer (p. 356) and Table notes 1-7 (p. 357) are applicable.

SDW TRUSS-PLY – Allowable Loads for Side-Loaded Multi-Ply Lumber Assemblies

Assembly Illustration	Assembly Description	Model No.	Nominal Screw Length (in.)	Allowable Load for Side-Loaded Multi-Ply Assembly per Screw			
				$(P_{allow}$ lb.)			
				DF/SP		SPF/HF	
				Head Side	Point Side	Head Side	Point Side
A-W	2-ply 2x/truss	SDW22300	2 15/16	650	650	510	510
B-W	Desert 3-ply 2x/truss	SDW22438	4 ¾	600	410	485	380
B-W	3-ply 2x/truss	SDW22458	4 ¾	600	410	485	380
C-W	Desert 4-ply 2x/truss	SDW22600	6	530	365	450	340
C-W	4-ply 2x/truss	SDW22638	6 ¾	530	365	450	340

1. Loads based on specific gravity of 0.50 for DF/SP and 0.42 for SPF/HF.
2. Allowable loads include a load duration factor of $C_D = 1.00$ and may be increased up to $C_D = 1.60$ per the building code when applicable.
3. SDW Truss-Ply allowable shear loads are from p. 356.
4. Notes to Designer (p. 356) and Table notes 1-5 (p. 358) are applicable.

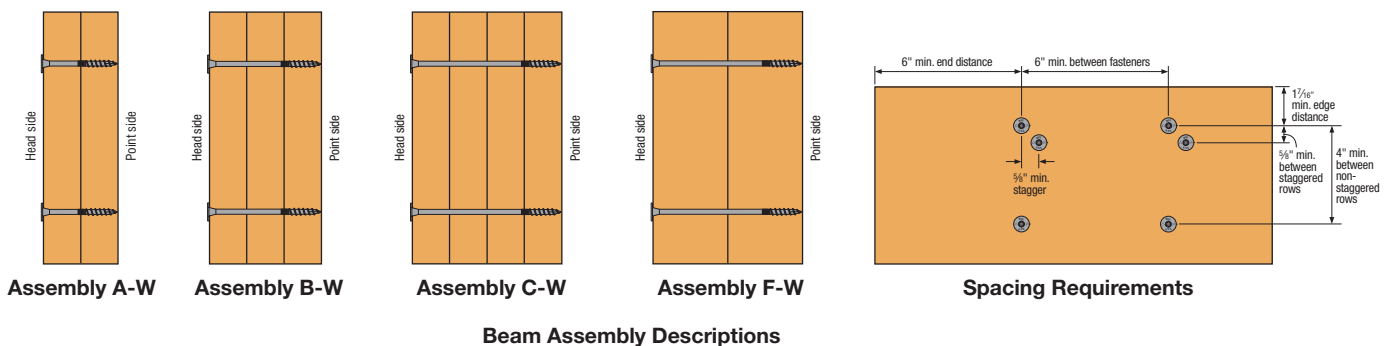

Load Tables, Technical Data and Installation Instructions

Strong-Drive® SDW TRUSS-PLY and EWP-PLY Screws (cont.)

SDW-Built-Up Column Assemblies

Built-up column assemblies shown in this section determine the *Column Stability Coefficient*, K_f , when fastened using SDW Truss-Ply screws. For use with Section 15.3.2 of the 2012 and 2015 NDS, the table provides Strong-Drive SDW Truss-Ply screw substitution information to replace nails or bolts in built-up columns per Section 15.3.3 and 15.3.4 of NDS. Tabulated compression values using these coefficients are listed on pp. 362–363 for common conditions.

Design Parameters for Built-Up Columns using SDW Truss-Ply screws:

- $K_f = 0.60$ for SDW installed on one side
- $K_f = 0.70$ for SDW installed on both sides
- $l_e/d \leq 50$
- Each lamination (ply) has a rectangular cross-section and is at least 1 1/2" thick
- All laminations have same face width, d_1
- Faces of adjacent laminations are in contact
- All laminations are full length
- Number of laminations: 2 to 4

SDW TRUSS-PLY Screw Substitution Table for NDS Specifications

No. of Plies	Minimum Nominal Lumber Size (in.)	NDS Specification				SDW Truss-Ply Screw Substitution			
		Fastener ¹	NDS Reference	Installation	Spacing (in.)	Model No.	Description	Installation	Spacing (in.)
2	2 x 4	10d common	Figure 15C	Both sides	6	SDW22300	0.22" dia. X 3" long screw	One side	6
								Both sides	8
3	2 x 4	30d common	Figure 15C	Both sides	8	SDW22438	0.22" dia. X 4 3/8" long screw	One side	8
								Both sides	9
	2 x 6							One side	9
	Both sides							10	
4	2 x 6	1/2" bolts	Figure 15D	One side	8	SDW22600	0.22" dia. X 6" long screw	One side	7
								Both sides	8

1. 10d common: 0.148" dia. X 3" long nail.

2. 30d common: 0.207" dia. X 4 1/2" long nail.

3. 1/2" bolts: 1/2" bolts with a washer between the wood and the bolt head and between the wood and the nut.

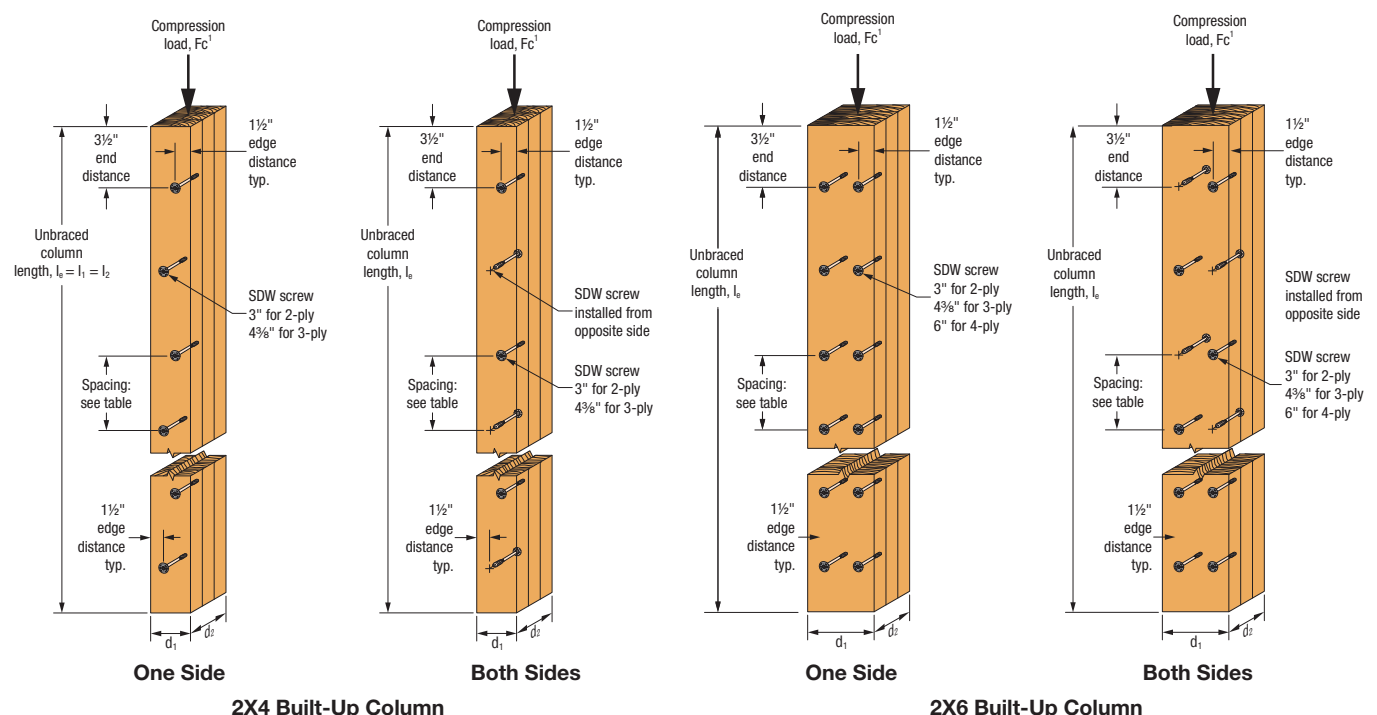

C-F-2017 © 2017 SIMPSON STRONG-TIE COMPANY INC.

Load Tables, Technical Data and Installation Instructions

Allowable Compression Capacity for Built-Up Columns

Lumber		Fastener			Allowable Compression Capacity Parallel to Grain, F _c ' (lb.)																			
Size	No. of Plies	Model Number	Spacing	Installation	Floor (100)					Snow (115)					Roof (125)					Wind/Seismic (160)				
					Unbraced Length, ℓ _e (ft.)					Unbraced Length, ℓ _e (ft.)					Unbraced Length, ℓ _e (ft.)					Unbraced Length, ℓ _e (ft.)				
					8	9	10	11	12	8	9	10	11	12	8	9	10	11	12	8	9	10	11	12
Southern Pine No. 2																								
2x4	2	SDW22300	6	One side	2,405	1,935	1,585	1,320	1,115	2,435	1,950	1,595	1,325	1,120	2,445	1,955	1,600	1,330	1,120	2,480	1,975	1,610	1,335	1,125
				Both sides	2,810	2,255	1,850	1,540	1,300	2,840	2,275	1,860	1,545	1,305	2,855	2,285	1,865	1,550	1,310	2,890	2,305	1,880	1,560	1,315
	3	SDW22438	8	One side	7,145	5,960	4,995	4,225	3,610	7,395	6,105	5,085	4,285	3,650	7,525	6,180	5,130	4,315	3,670	7,835	6,360	5,240	4,385	3,715
				Both sides	7,930	6,430	5,295	4,430	3,755	8,060	6,505	5,345	4,460	3,775	8,130	6,545	5,370	4,475	3,785	8,290	6,640	5,430	4,515	3,810
	4	SDW22600	6	One side	10,575	8,575	7,065	5,905	5,005	10,750	8,675	7,125	5,945	5,030	10,840	8,725	7,160	5,970	5,045	11,055	8,855	7,235	6,020	5,080
				8	Both sides	10,575	8,575	7,065	5,905	5,005	10,750	8,675	7,125	5,945	5,030	10,840	8,725	7,160	5,970	5,045	11,055	8,855	7,235	6,020
2x6	2	SDW22300	6	One side	3,770	3,035	2,485	2,070	1,750	3,815	3,055	2,500	2,080	1,760	3,835	3,070	2,510	2,085	1,760	3,890	3,100	2,530	2,100	1,770
				Both sides	4,400	3,540	2,900	2,415	2,040	4,450	3,565	2,920	2,430	2,050	4,475	3,580	2,925	2,435	2,055	4,535	3,620	2,950	2,450	2,065
	3	SDW22438	8	One side	11,120	9,300	7,815	6,615	5,655	11,530	9,540	7,960	6,710	5,720	11,745	9,665	8,035	6,760	5,750	12,250	9,955	8,215	6,875	5,830
				Both sides	12,975	10,850	9,115	7,720	6,600	13,450	11,130	9,285	7,830	6,675	13,700	11,275	9,375	7,885	6,710	14,290	11,615	9,585	8,025	6,805
	4	SDW22600	8	One side	20,575	18,380	16,200	14,180	12,400	22,215	19,490	16,920	14,655	12,720	23,130	20,080	17,300	14,900	12,885	25,515	21,545	18,215	15,490	13,275
				Both sides	24,005	21,445	18,895	16,545	14,470	25,915	22,735	19,740	17,100	14,840	26,990	23,430	20,185	17,385	15,035	29,765	25,140	21,250	18,070	15,490
2x8	2	SDW22300	6	One side	4,955	3,990	3,270	2,725	2,305	5,015	4,020	3,290	2,740	2,315	5,045	4,040	3,305	2,750	2,320	5,115	4,085	3,330	2,765	2,330
				Both sides	5,780	4,655	3,815	3,180	2,690	5,850	4,690	3,840	3,195	2,700	5,885	4,715	3,855	3,205	2,705	5,970	4,765	3,885	3,225	2,720
	3	SDW22438	8	One side	14,505	12,170	10,245	8,685	7,430	15,070	12,500	10,445	8,815	7,520	15,360	12,670	10,550	8,885	7,565	16,065	13,075	10,800	9,045	7,675
				Both sides	16,920	14,200	11,950	10,135	8,670	17,580	14,585	12,185	10,285	8,775	17,920	14,780	12,310	10,365	8,825	18,740	15,255	12,600	10,550	8,955
	4	SDW22600	8	One side	26,540	23,825	21,080	18,510	16,225	28,735	25,325	22,070	19,165	16,665	29,970	26,140	22,595	19,505	16,895	33,215	28,155	23,855	20,315	17,435
				Both sides	30,965	27,795	24,590	21,595	18,930	33,520	29,550	25,750	22,360	19,445	34,970	30,495	26,360	22,755	19,710	38,750	32,845	27,830	23,705	20,340
Spruce-Pine-Fir No. 1/No. 2																								
2x4	2	SDW22300	6	One side	2,385	1,925	1,575	1,315	1,110	2,415	1,940	1,590	1,320	1,115	2,430	1,950	1,595	1,325	1,120	2,465	1,970	1,605	1,335	1,125
				Both sides	2,785	2,245	1,840	1,535	1,295	2,820	2,265	1,850	1,540	1,305	2,835	2,275	1,860	1,545	1,305	2,880	2,300	1,875	1,555	1,315
	3	SDW22438	8	One side	6,955	5,850	4,930	4,185	3,580	7,235	6,015	5,030	4,250	3,625	7,380	6,095	5,080	4,280	3,645	7,730	6,300	5,205	4,360	3,700
				Both sides	7,830	6,375	5,260	4,405	3,735	7,980	6,460	5,315	4,440	3,760	8,055	6,500	5,340	4,460	3,775	8,235	6,610	5,405	4,500	3,805
	4	SDW22600	6	One side	10,445	8,495	7,015	5,875	4,985	10,640	8,610	7,085	5,920	5,015	10,740	8,670	7,120	5,945	5,030	10,980	8,810	7,210	6,000	5,070
				8	Both sides	10,445	8,495	7,015	5,875	4,985	10,640	8,610	7,085	5,920	5,015	10,740	8,670	7,120	5,945	5,030	10,980	8,810	7,210	6,000
2x6	2	SDW22300	6	One side	3,735	3,010	2,470	2,060	1,745	3,785	3,040	2,490	2,075	1,755	3,810	3,055	2,500	2,080	1,755	3,870	3,090	2,520	2,095	1,765
				Both sides	4,360	3,515	2,885	2,405	2,035	4,415	3,545	2,905	2,420	2,045	4,445	3,565	2,915	2,425	2,050	4,515	3,605	2,940	2,445	2,060
	3	SDW22438	8	One side	10,780	9,100	7,690	6,535	5,605	11,240	9,370	7,855	6,645	5,675	11,480	9,510	7,945	6,700	5,710	12,060	9,850	8,150	6,835	5,800
				Both sides	12,575	10,615	8,970	7,625	6,535	13,115	10,935	9,165	7,750	6,620	13,395	11,100	9,265	7,815	6,665	14,070	11,490	9,505	7,970	6,770
	4	SDW22600	8	One side	19,335	17,500	15,600	13,780	12,130	21,035	18,700	16,410	14,320	12,495	22,010	19,355	16,835	14,600	12,685	24,600	20,995	17,875	15,270	13,130
				Both sides	22,555	20,420	18,200	16,075	14,155	24,540	21,815	19,140	16,705	14,580	25,675	22,580	19,640	17,030	14,795	28,700	24,495	20,850	17,815	15,320
2x8	2	SDW22300	6	One side	4,900	3,955	3,250	2,715	2,295	4,965	3,995	3,275	2,730	2,305	5,000	4,015	3,290	2,735	2,315	5,085	4,065	3,320	2,760	2,325
				Both sides	5,715	4,615	3,790	3,165	2,680	5,795	4,660	3,820	3,185	2,690	5,835	4,685	3,835	3,195	2,700	5,935	4,745	3,870	3,220	2,715
	3	SDW22438	8	One side	13,980	11,860	10,050	8,565	7,350	14,625	12,240	10,285	8,715	7,450	14,960	12,440	10,410	8,790	7,505	15,775	12,910	10,695	8,980	7,630
				Both sides	16,310	13,835	11,730	9,990	8,575	17,060	14,280	12,000	10,165	8,695	17,455	14,510	12,145	10,260	8,755	18,405	15,060	12,480	10,475	8,900
	4	SDW22600	8	One side	24,725	22,510	20,175	17,900	15,810	26,990	24,140	21,290	18,650	16,320	28,300	25,040	21,885	19,045	16,585	31,835	27,315	23,335	19,985	17,210
				Both sides	28,850	26,265	23,540	20,885	18,445	31,490	28,165	24,840	21,760	19,040	33,020	29,210	25,530	22,215	19,350	37,140	31,865	27,225	23,315	20,080

1. Adjustment factors: [C_M, C_t, C_i] = 1.0. For C_r refer to NDS, Table 4A.
2. For LRFD, see NDS, Section 4.3.

3. Compression perpendicular to grain has not been evaluated.
4. All SDW screws have an E-coat™. Simpson Strong-Tie has conducted testing per Acceptance Criteria AC257, showing in dry conditions E-coat™ performs equivalent to hot-dip galvanized (HDG) coating.

5. For fire retardant treated (FRT) wood, additional reduction factors may need to be applied based on the manufacturer's recommendations.
6. The column capacities are evaluated for column being completely unbraced in both strong and weak axis. ℓ_o = ℓ₁ = ℓ₂.

Load Tables, Technical Data and Installation Instructions

Allowable Compression Capacity for Built-Up Columns

Lumber		Fastener			Allowable Compression Capacity Parallel to Grain, F _c ' (lb.)																							
Size	No. of Plies	Model Number	Spacing	Installation	Floor (100)					Snow (115)					Roof (125)					Wind/Seismic (160)								
					Unbraced Length, l _e (ft.)					Unbraced Length, l _e (ft.)					Unbraced Length, l _e (ft.)					Unbraced Length, l _e (ft.)								
					8	9	10	11	12	8	9	10	11	12	8	9	10	11	12	8	9	10	11	12				
Douglas-Fir Larch No. 2																												
2x4	2	SDW22300	6	One side	2,725	2,190	1,795	1,495	1,265	2,755	2,210	1,810	1,505	1,270	2,770	2,220	1,815	1,510	1,275	2,810	2,245	1,830	1,520	1,280				
				Both sides	3,175	2,555	2,095	1,745	1,475	3,215	2,580	2,110	1,755	1,485	3,235	2,590	2,115	1,760	1,485	3,280	2,615	2,135	1,770	1,495				
	3	SDW22438	8	One side	7,990	6,695	5,635	4,775	4,085	8,295	6,875	5,745	4,845	4,130	8,455	6,970	5,800	4,880	4,155	8,835	7,185	5,935	4,970	4,215				
				Both sides	8,950	7,270	6,000	5,020	4,255	9,110	7,365	6,055	5,055	4,280	9,190	7,410	6,085	5,075	4,295	9,390	7,530	6,160	5,125	4,330				
	4	SDW22600	6	One side	11,930	9,695	7,995	6,695	5,675	12,145	9,820	8,075	6,745	5,710	12,255	9,880	8,115	6,770	5,725	12,520	10,035	8,210	6,835	5,770				
				8	Both sides	11,930	9,695	7,995	6,695	5,675	12,145	9,820	8,075	6,745	5,710	12,255	9,880	8,115	6,770	5,725	12,520	10,035	8,210	6,835	5,770			
2x6	2	SDW22300	6	One side	4,260	3,435	2,815	2,350	1,985	4,315	3,465	2,835	2,360	1,995	4,340	3,480	2,845	2,370	2,000	4,405	3,520	2,870	2,385	2,010				
				Both sides	4,970	4,005	3,285	2,740	2,320	5,035	4,040	3,310	2,755	2,330	5,065	4,060	3,320	2,765	2,335	5,140	4,105	3,350	2,780	2,345				
	3	SDW22438	8	One side	12,385	10,425	8,790	7,465	6,390	12,890	10,720	8,975	7,580	6,470	13,155	10,875	9,065	7,640	6,510	13,790	11,240	9,290	7,785	6,610				
				Both sides	14,450	12,160	10,255	8,710	7,455	15,040	12,510	10,470	8,845	7,550	15,345	12,685	10,580	8,915	7,595	16,085	13,115	10,840	9,085	7,710				
	4	SDW22600	8	One side	22,435	20,225	17,960	15,820	13,895	24,350	21,555	18,850	16,410	14,295	25,440	22,280	19,320	16,715	14,500	28,315	24,085	20,455	17,445	14,985				
				Both sides	26,170	23,595	20,955	18,455	16,215	28,405	25,145	21,990	19,145	16,675	29,675	25,990	22,540	19,500	16,915	33,035	28,095	23,860	20,355	17,485				
2x8	2	SDW22300	6	One side	5,590	4,510	3,705	3,090	2,615	5,665	4,555	3,730	3,105	2,625	5,705	4,575	3,745	3,115	2,635	5,795	4,630	3,780	3,140	2,650				
				Both sides	6,525	5,260	4,320	3,605	3,050	6,610	5,310	4,350	3,625	3,065	6,655	5,340	4,370	3,635	3,070	6,760	5,400	4,410	3,660	3,090				
	3	SDW22438	8	One side	16,075	13,590	11,495	9,780	8,385	16,780	14,010	11,755	9,945	8,495	17,150	14,225	11,885	10,030	8,555	18,035	14,740	12,200	10,235	8,690				
				Both sides	18,755	15,855	13,415	11,410	9,785	19,580	16,345	13,710	11,605	9,915	20,010	16,595	13,865	11,700	9,980	21,045	17,195	14,235	11,940	10,140				
	4	SDW22600	8	One side	28,710	26,035	23,245	20,565	18,125	31,270	27,850	24,475	21,385	18,680	32,740	28,845	25,130	21,815	18,965	36,670	31,350	26,715	22,840	19,650				
				Both sides	33,495	30,375	27,120	23,990	21,145	36,480	32,490	28,555	24,950	21,795	38,195	33,650	29,315	25,450	22,125	42,780	36,575	31,165	26,645	22,925				
Hem-Fir No. 2																												
2x4	2	SDW22300	6	One side	2,235	1,795	1,465	1,220	1,030	2,260	1,805	1,475	1,225	1,035	2,270	1,810	1,480	1,230	1,035	2,295	1,830	1,490	1,235	1,040				
				Both sides	2,610	2,095	1,710	1,425	1,205	2,635	2,105	1,720	1,430	1,205	2,645	2,115	1,725	1,435	1,210	2,675	2,130	1,735	1,440	1,215				
	3	SDW22438	8	One side	6,775	5,600	4,670	3,940	3,355	6,975	5,715	4,745	3,985	3,385	7,075	5,775	4,780	4,010	3,405	7,320	5,920	4,865	4,065	3,440				
				Both sides	7,410	5,985	4,915	4,105	3,475	7,510	6,045	4,955	4,130	3,490	7,565	6,075	4,975	4,140	3,500	7,695	6,150	5,020	4,175	3,520				
	4	SDW22600	6	One side	9,875	7,975	6,555	5,475	4,635	10,015	8,060	6,605	5,505	4,655	10,085	8,100	6,630	5,525	4,665	10,260	8,200	6,695	5,565	4,695				
				8	Both sides	9,875	7,975	6,555	5,475	4,635	10,015	8,060	6,605	5,505	4,655	10,085	8,100	6,630	5,525	4,665	10,260	8,200	6,695	5,565	4,695			
2x6	2	SDW22300	6	One side	3,505	2,810	2,300	1,915	1,620	3,540	2,830	2,315	1,925	1,625	3,555	2,840	2,320	1,930	1,625	3,600	2,870	2,335	1,940	1,635				
				Both sides	4,090	3,280	2,685	2,235	1,890	4,130	3,305	2,700	2,245	1,895	4,150	3,315	2,705	2,250	1,900	4,200	3,345	2,725	2,265	1,905				
	3	SDW22438	8	One side	10,535	8,740	7,300	6,165	5,255	10,865	8,930	7,420	6,240	5,310	11,035	9,030	7,480	6,280	5,335	11,445	9,265	7,625	6,375	5,400				
				Both sides	12,290	10,195	8,520	7,190	6,135	12,675	10,420	8,655	7,280	6,195	12,875	10,535	8,730	7,325	6,225	13,350	10,810	8,895	7,435	6,300				
	4	SDW22600	8	One side	20,080	17,705	15,430	13,400	11,650	21,510	18,630	16,020	13,780	11,905	22,295	19,120	16,325	13,980	12,040	24,275	20,310	17,060	14,450	12,355				
				Both sides	23,430	20,655	18,000	15,630	13,595	25,095	21,735	18,690	16,080	13,890	26,010	22,305	19,050	16,310	14,045	28,320	23,695	19,905	16,860	14,415				
2x8	2	SDW22300	6	One side	4,605	3,695	3,025	2,520	2,130	4,650	3,725	3,045	2,535	2,140	4,675	3,740	3,055	2,540	2,145	4,735	3,775	3,075	2,555	2,155				
				Both sides	5,370	4,315	3,530	2,940	2,485	5,425	4,345	3,550	2,955	2,495	5,455	4,365	3,565	2,960	2,500	5,525	4,405	3,590	2,980	2,510				
	3	SDW22438	8	One side	13,720	11,425	9,570	8,085	6,905	14,185	11,695	9,735	8,195	6,975	14,425	11,830	9,815	8,250	7,015	14,995	12,160	10,020	8,380	7,100				
				Both sides	16,005	13,325	11,160	9,435	8,055	16,550	13,640	11,355	9,560	8,140	16,830	13,805	11,455	9,625	8,180	17,495	14,190	11,690	9,775	8,285				
	4	SDW22600	8	One side	25,810	22,890	20,050	17,470	15,230	27,745	24,170	20,875	18,010	15,590	28,820	24,850	21,300	18,285	15,775	31,560	26,510	22,330	18,945	16,215				
				Both sides	30,115	26,705	23,390	20,385	17,770	32,370	28,195	24,350	21,010	18,190	33,620	28,990	24,850	21,335	18,405	36,820	30,930	26,055	22,105	18,920				

- Adjustment factors: [C_M, C_t, C_e] = 1.0. For C_e refer to NDS, Table 4.A.
- For LFRD, see NDS, Section 4.3.
- Compression perpendicular to grain has not been evaluated.
- All SDW screws have an E-coat™. Simpson Strong-Tie has conducted testing per Acceptance Criteria AC257, showing in dry conditions E-coat™ performs equivalent to hot-dip galvanized (HDG) coating.
- For fire retardant treated (FRT) wood, additional reduction factors may need to be applied based on the manufacturer's recommendations.
- The column capacities are evaluated for column being completely unbraced in both strong and weak axis. l_o = l₁ = l₂.

Load Tables, Technical Data and Installation Instructions

Strong-Drive® SDWV SOLE-TO-RIM Screw

Sole-to-Rim Attachment

The Simpson Strong-Tie® SDWV Sole-to-Rim structural wood screws may be used to attach a sole plate to a rim board according to the following table.

Features:

- Large 0.400 diameter head for increased holding power
- Fast start point with helical ridge for fast, easy, low torque installation
- Variable thread design, optimized for 2x nominal dimension lumber

For more information, see p. 95

U.S. Patent: 6,074,149

SDWV – Allowable Shear Loads for Sole-to-Rim Connection

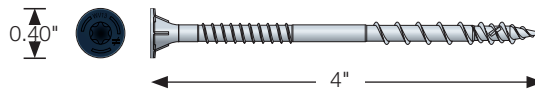

Size	Model No.	Sole Plate Nominal Size (in.)	Minimum Penetration into Rim Board (in.)	Allowable Loads (lb.) per Screw							
				2x Min. DF/SP Rim Board		2x Min. SPF/HF Rim Board		1 ¼" Min. LVL Rim Board		1 ¼" Min. LSL Rim Board	
				DF/SP Sole Plate	SPF/HF Sole Plate	DF/SP Sole Plate	SPF/HF Sole Plate	DF/SP Sole Plate	SPF/HF Sole Plate	DF/SP Sole Plate	SPF/HF Sole Plate
0.135 x 4	SDWV13400Z	2x	1.75	220	175	165	160	185	165	185	175

1. Allowable loads are based on testing per ICC-ES AC233 and are limited to parallel-to-grain loading. The equivalent specific gravity for the LVL and LSL for edge fastening is 0.50".
2. Allowable loads are shown at the wood load duration factor of $C_D = 1.00$. Loads may be increased for load duration as permitted by the building code up to a $C_D = 1.60$.
3. Minimum spacing of the SDWV is 6" o.c., minimum end distance is 6", and minimum edge distance is 5/8".
4. Wood structural panel up to 3/8" thick is permitted between the sole plate and rim board provided it is fastened to the rim board per code and the minimum penetration of the screw into the rim board is met.

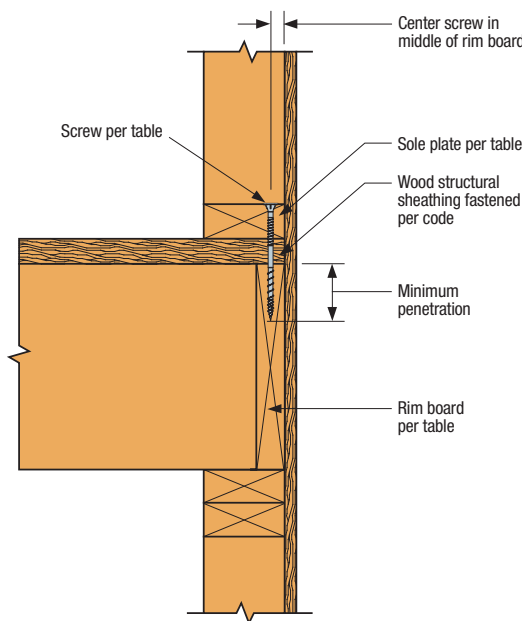

Load Tables, Technical Data and Installation Instructions

Strong-Drive® TB WOOD-TO-STEEL Screw

Common Applications:

- Wood to hot-rolled steel (Maximum recommended thicknesses: 5/16")

For More Product Information, see p. 100

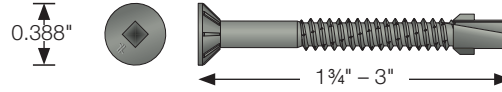

TB – Allowable Loads – DF and SP Lumber Attachment to Steel (Steel Members 16 ga. - 5/16" Thick)

Model No.	Length in. (mm)	Nominal Wood Thickness (in.)	Steel Thickness mil (ga.)	DF/SP Allowable Load (lb.)			
				Uplift		Shear	
				C _d =1.0	C _d =1.6	C _d =1.0	C _d =1.6
TB1460S	2 3/8 (60)	2x	54 (16)	195	195	210	335
			68 (14)	225	225	210	335
			97-312 (12 - 5/16")	245	390	215	345
TB1475S	3 (75)		54 (16)	195	195	210	335
			68 (14)	225	225	210	335
			97-312 (12 - 5/16")	245	390	215	345

1. For use with structural steel members up to 5/16" thick or cold-formed steel members 54 mil (16 ga.) or thicker.
2. Standard product available in a black phosphate, yellow zinc or N2000 coating for additional corrosion protection (TBG1460S or TBG1475S).
3. For use with 2x (1 1/2") DF/SP only.
4. For use with QD HSD60 or HSD75 Tool.
5. Use increased allowable loads (C_d=1.6) only when resisting wind or seismic forces.

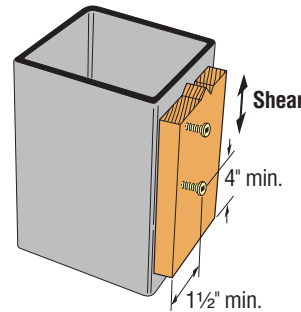
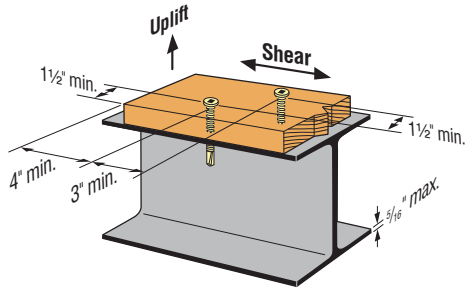

Load Tables, Technical Data and Installation Instructions

Strong-Drive® WSNTL SUBFLOOR Screw

For Subfloor and Sheathing to wood, Multi-Ply Wood Members

Codes/Standards: ICC-ES ESR-1472; City of L.A. RR25661 (Note: 1 3/4" length not code listed)

For More Product Information, see p. 96

WSNTL – Allowable Shear – Wood Structural Panel Diaphragms with Framing of Douglas Fir-Larch or Southern Pine for Wind or Seismic Loading (2", 2 1/2" and 3" Lengths) (in Pounds per Foot)¹⁻⁸

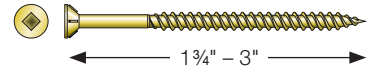

Panel Grade	Minimum Nominal Panel Thickness (in.)	Minimum Nominal Width of Framing Members at Adjoining Panel Edges and Boundaries (in.) ^{4,5}	Blocked Diaphragms				Unblocked Diaphragms	
			Screw spacing (inches) at diaphragm boundaries (all cases), at continuous panel edges parallel to load (Cases 3 and 4), and at all edges (Cases 5 and 6) ⁶				Screws Spaced 6", Maximum, at Support Edges ⁶	
			6	4	2 1/2 ⁷	2 ⁷	Case 1 (no unblocked edges or continuous joints parallel to load)	All other configurations (Cases 2,3,4,5 and 6)
			Screw Spacing (in.) at Other Panel Edges					
6	6	4	3					
Structural ¹	3/8	2	270	360	530	600	240	180
		3	300	400	600	675	265	200
	15/32	2	320	425	640	730	285	215
		3	360	480	720	820	320	240
Sheathing and single floor	3/8	2	240	320	480	545	215	160
		3	270	360	540	610	240	180
	7/16	2	255	340	505	575	230	170
		3	285	380	570	645	255	190
	15/32	2	290	385	575	655	255	190
		3	325	430	650	735	290	215
	19/32	2	320	421	640	730	285	215
		3	360	480	720	820	320	240

- Minimum fastener penetration of 1 1/4" into the framing member is required.
- For wind design, shear capacities may be increased 40% per section 2306.3.2 of the 2006 IBC, 2306.2.1 of the 2009 IBC, and 2306.2 of the 2012/2015 IBC.
- Allowable loads are shown at the wood load duration of C_D=1.6. No further increases shall be permitted. For shear loads of normal or permanent load duration as defined by the NDS-2012, the values in the table above must be multiplied by 0.63 or 0.56, respectively.
- The minimum nominal width of framing members not located at boundaries or adjoining panel edges must be 2".
- Framing at adjoining panel edges must be 3" nominal or wider, and screws must be staggered where both of the following conditions are met: (1) screws having penetration into framing of more than 1 1/2" and (2) screws are spaced 3" o.c. or less.
- Space screws maximum 12" o.c. along intermediate framing members (6" o.c. where supports are spaced 48" o.c.).
- Framing at adjoining panel edges must be 3" nominal or wider, and screws must be staggered where screws are spaced 2" or 2 1/2" on center.
- See ICC-ES ESR-1472 for allowable shear loads for high load diaphragms.

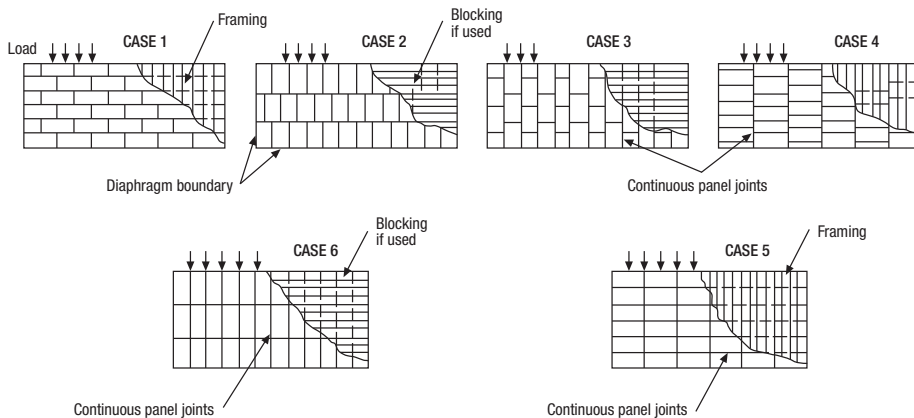

Load Tables, Technical Data and Installation Instructions

Strong-Drive® WSNTL SUBFLOOR Screw (cont.)

WSNTL – Allowable Withdrawal and Pull-Through Loads for Wind or Seismic Loading¹⁻⁶

Model No. ⁶	Nominal Screw Length (in.)	Thread Length (in.)	Allowable Pull-Through ¹ (lb.)				Reference Allowable Withdrawal Load per Thread Penetration (lb./in.)		
			Minimum Nominal Panel Thickness (in.)				Framing Member ³		
			OSB/Plywood Rated Sheathing, Exposure 1						
			7/16	1 ⁵ / ₃₂	1 ⁹ / ₃₂	2 ³ / ₃₂	2x SPF/HF	2x DFL	2x SP
WSNTL2LS	1.94	1.47	70	71	116	116	93	133	175
WSNTL212S	2.50	1.97							
WSNTL3S	3.00	2.17							

1. Use the lower of the pull-through or withdrawal values to determine axial design value.

2. Screws must be installed straight into the side grain of the wood main member with the screw axis at a 90° angle to the wood fibers.

3. The main framing member must be wood having a minimum specific gravity of 0.50 for DFL and SP main members, and 0.42 for SPF and HF main members. DFL is Douglas Fir-Larch. SP is Southern Pine. SPF is Spruce-Pine-Fir. HF is Hem-Fir.

4. Table based on testing conducted in accordance with AC233. Design values presented are based on average ultimate values and divided by 5.

5. Allowable loads are shown at the wood load duration factor of $C_D = 1.0$. Loads may be increased for load duration up to $C_D = 1.6$.

6. The model number may end in the designation L or R, indicating that the screws are packaged as collated or for hand drive, respectively.

IBC Equivalent Prescriptive Fastening Schedule¹

Connection	Fastening	Location
2015 IBC Table 2304.10.1		
19. 1" brace to each stud and plate	2 screws	Face
21. 1" x 8" and wider sheathing to each bearing	3 screws	Face
24. 1" x 6" subfloor or less to each joist	2 screws	Face
2012, 2009 and 2006 IBC Table 2304.9.1		
3. 1" x 6" subfloor or less to each joist	2 screws	Face
4. Wider than 1" x 6" subfloor to each joist	3 screws	Face
20. 1" diagonal brace to each stud and plate	2 screws	Face
21. 1" x 8" sheathing to each bearing	3 screws	Face
22. Wider than 1" x 8" sheathing to each bearing	3 screws	Face

1. Fastener penetration into the supporting member must be a minimum of 1³/₁₆".

Load Tables, Technical Data and Installation Instructions

Strong-Drive® WSNTL SUBFLOOR Screw (cont.)

Simpson Strong-Tie® Strong Drive® WSNTL series #8 flathead, countersunk wood screws are a fast and reliable method for attaching 2-ply and 3-ply girder trusses.

WSNTL – Allowable Loads Comparison of Common Fasteners Used to Attach Truss Plies Together¹⁻⁶

Fastener ⁷	Length (in.)	Diameter (in.)	Shear (lb.)			Withdrawal (lb.)		
			DFL	SP	SPF	DFL	SP	SPF
WSNTL212S	2½	0.132	85	95	70	133	175	93
WSNTL3S	3	0.132	100	110	85	200	263	140
0.120" collated nail ⁵	3	0.120	81	89	69	44	56	28
0.131" collated nail ⁵	3	0.131	97	106	82	48	61	31

- Table values are based on attachment of a 1½" side member to a 1½" main member of the same species and grade.
- Table values are based on the 2012 NDS, $C_D=1.0$. Values shall be multiplied by all applicable factors, such as duration of load, etc. except where noted.
- Specific Gravities (G) assumed: DFL G = 0.50, SP G = 0.55, SPF G = 0.42.
- The spacing of applied uniform loads to the multi-ply member shall not exceed 24 inches on center.
- Assumes collated nail $F_{yb} = 100$ ksi.
- WSNTL212S and WSNTL3S withdrawal values based on testing per AC233.
- The model name may end in the designation L or R, indicating that the screws are packaged as collated or for hand drive, respectively.

Installation:

- Screw spacing shall be in accordance with the fastener schedule provided on the Truss Design Drawing or as otherwise approved by the Truss Designer. Screw spacing shall not exceed 12" on center and shall not be less than 3" on center.
- WSNTL series screws may be installed with the screw heads in either the loaded or unloaded ply. Do not overdrive screws.
- For 3-ply girder assemblies, the WSNTL screws may be installed from the same side as each ply is applied (no flipping of the truss is required) in accordance with BCSI (2006 edition). Girders that are fastened together at the jobsite must have the fastener heads visible for inspection.
- Stagger the screws in the third ply a minimum of 1" from the screws installed into the first two plies.
- Individual screw locations may be adjusted up to ½ of the required screw spacing to avoid conflicts with other hardware or to avoid lumber defects. (3" minimum spacing still required.)
- Use minimum of 3" long fasteners to attach hangers to the girder truss.
- A 2,500-rpm motor is recommended.

2-Ply Assembly

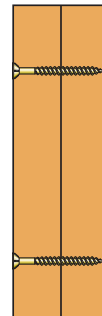

3-Ply Assemblies

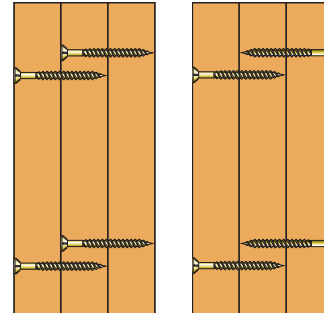

Truss Plant Installation

Jobsite Installation

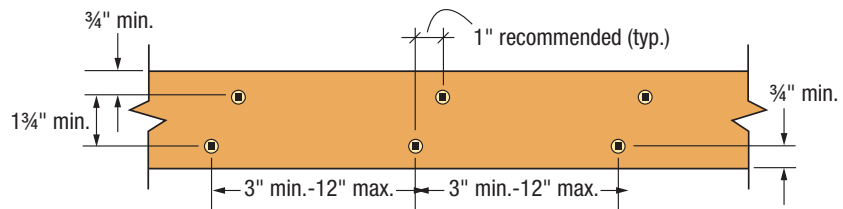

Typical Spacing for WSNTL Screw

Ply-To-Ply Connection Comparison for a 30' Long 3-Ply Girder – Bottom Chord Loading

Sample Bottom Chord Nailing Requirement for 3-ply Girder using 0.120 x 3" Collated Nails

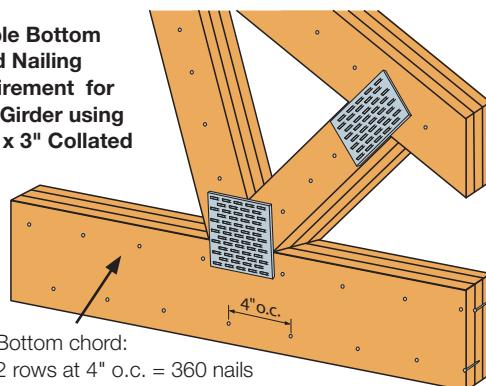

Alternate Fastening using WSNTL3S Screw

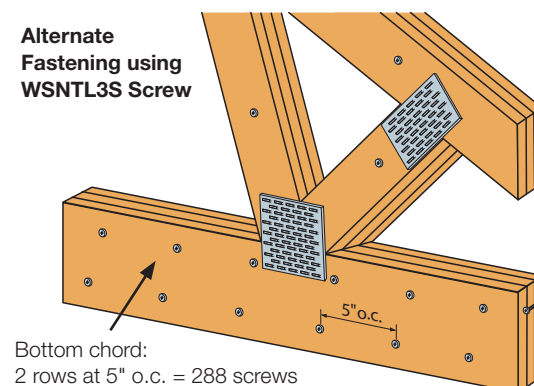

Examples based on 3-ply girder spanning 30', 2x6 Southern Pine bottom chords, 825 plf BC load and 1.15 load duration. Nail and screw spacing is repeated for each layer.

Load Tables, Technical Data and Installation Instructions

Strong-Drive® WSNTL SUBFLOOR Screw (cont.)

2"-3" WSNTL Fasteners Meet Code Requirements

As listed in ICC-ES ESR-1472, WSNTL screws meet code requirements for the 2015 and 2012 International Building Code (IBC) and International Residential Code (IRC). Evaluation report recognized uses of WSNTL screws include the following applications:

- Substitute for 8d and 10d nails in horizontal diaphragms per AWC SDPWS-2008 and IBC (2012 and 2015) Tables 4.2A, 4.2B, and 4.2C
- Code-prescribed wood connections per IBC Tables 2306.3.1, 2304.9.1 and 2304.10.1
- Single, diagonally-sheathed lumber diaphragms per AWC SDPWS Table 4.2C (IBC 2012 and 2015)
- Prescriptive sheathing applications in IRC Table R602.3(1) and in structures regulated by the IRC where an engineered design is submitted in accordance with IRC R301.1.3

Guidelines for Fastening Diaphragms without Glue

The design of wood floor systems constructed with wood structural panel (WSP) sheathing fastened to framing considers the diaphragm performance of the system as presented in the codes (as affected by framing, sheathing thickness, sheathing layout and fastening) and may also consider the composite action of the sheathing with the framing system (composite action is the combined stiffness of the joist with the sheathing). The framing systems can be grouped into two classes: (1) sawn lumber and parallel-chord wood trusses, and (2) wood I-joists. WSNTL screws may be used as alternate fasteners to common nails in each floor class subject to certain constraints.

For Diaphragms with a Framing System that is Sawn Lumber or Parallel-Chord Wood Trusses

Simpson Strong-Tie WSNTL screws may be used as one-for-one substitutes for 10d common and smaller nails that are specified for horizontal diaphragm design in accordance with the 2015 and 2012 IBC and IRC.



The Original "No Glue" Solution for Subfloor



For Diaphragms with Wood I-Joist Framing Systems

I-joist manufacturers use the extra stiffness resulting from composite action when developing allowable floor joist span tables. Therefore, I-joist floor span tables generally assume glued-nailed construction.

1. For floor systems designed or intended to be glued-nailed:
 - WSNTL screws may be substituted one-for-one for common nails, without glue, provided the maximum allowable I-joist span is reduced by 12" compared to the I-joist manufacturer's glued-nailed spans. The screws shall have at least 1 1/4" penetration into the I-joist flange (or full penetration for flanges less than 1 1/4" thick).
 - Where glue is used with the screws, no reduction in span is required.
 - Check with the I-joist manufacturer for any additional diaphragm requirements.
2. For floor systems designed or intended to be nailed-only:
 - WSNTL screws may be substituted one-for-one for common nails, with no reduction in span, provided at least 1 1/4" penetration into the I-joist flange is achieved (or full penetration for flanges less than 1 1/4" thick).
 - Check with the I-joist manufacturer for any additional diaphragm requirements.

Load Tables, Technical Data and Installation Instructions

Strong-Drive®

XE EXTERIOR STRUCTURAL METAL Screw

Structural Metal Connectors

For More Product Information, see p. 98

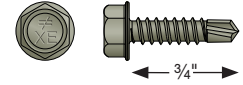

Cold-Formed Steel Member Connection Loads, Steel-to-Steel

Screw Size	Nominal Dia. d (in.)	Washer Dia. d _w (in.)	Load Description	Shear (lb.)						Pull-Over (lb.)						Pull-Out (lb.)					
				Steel Thickness: mil (ga.)						Steel Thickness: mil (ga.)						Steel Thickness: mil (ga.)					
				27 (22)	33 (20)	43 (18)	54 (16)	68 (14)	97 (12)	27 (22)	33 (20)	43 (18)	54 (16)	68 (14)	97 (12)	27 (22)	33 (20)	43 (18)	54 (16)	68 (14)	97 (12)
#10 x 3/4"	0.19	0.4	Allowable strength (ASD)	182	235	365	465	465	465	330	425	605	785	785	785	64	95	128	226	306	501
			Design strength (LRFD)	292	375	585	695	695	695	525	675	970	1,175	1,175	1,175	103	152	205	361	490	801
			Nominal strength	423	535	830	1,290	1,290	1,290	805	1,035	1,485	2,065	2,065	2,065	167	234	348	555	750	1,225

1. Screws and their connections have been tested per AISI Standard Test Method S904-08 and S905-08.

2. Loads are based on cold-formed steel members with a minimum yield strength, $F_y = 33$ ksi and tensile strength, $F_u = 45$ ksi for 43 mil (18 ga.) and thinner, and a minimum yield strength, $F_y = 50$ ksi and tensile strength, $F_u = 65$ ksi for 54 mil (16 ga.) and thicker.

3. Screws shall extend through the connection with a minimum of three exposed threads per AISI General Provisions Standard Section D1.3.

Screw Strength (lb.)

Screw Size	Nominal Strength		Design Strength (LRFD) $\phi = 0.5$		Allowable Strength (ASD) $\Omega = 3.0$	
	P_{ss}	P_{ts}	ϕP_{ss}	ϕP_{ts}	P_{ss}/Ω	P_{ts}/Ω
#10 x 3/4"	1,390	2,350	695	1,175	465	785

P_{ss} – Shear strength

P_{ts} – Tensile strength

Allowable Loads for Connectors in Trex Elevations

Model No.	Length (in.)	Fasteners	Allowable Loads (lb.) ^{1,2}	
			(F1)	
			43 mil (18 ga.)	68 mil (14 ga.)
L70Z	7	(8) #10	935	1,265
LS70Z	6%	(10) #10	600	1,070

1. Loads are for one part only.

2. Loads are for 8" headers/joists.

3. F1 load refers to the download or the uplift loads acting along the web of the joist/header.

Load Tables, Technical Data and Installation Instructions

Strong-Drive® PPSD SHEATHING-TO-CFS Screw

Common Application:

Wood structural panel/sheathing to cold-formed steel

(#8 – maximum thickness: 54 mil/16 ga.; #10 – maximum thickness: 97 mil/12 ga.)

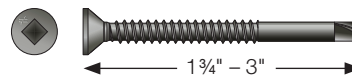
Codes/Standards: ASTM C1513 compliant, ICC-ES ESR-3006**For More Product Information,** see pp. 101, 276

PPSD – Pull-Out Loads – Steel Connections

Model No.	Screw Size	Load Description	Pull-out Loads (lb.)					
			Steel Thickness: mil (ga.)					
			27 (22)	33 (20)	43 (18)	54 (16)	68 (14)	97 (12)
PPSD11516S0818 PPSDQ11516S0818	#8	ASD	63	87	119	183	—	—
		LRFD	100	139	190	295	—	—
		Nominal strength	154	215	290	450	—	—
PPSD134S1016 PPSDQ134S1016	#10	ASD	80	128	194	315	425	480
		LRFD	128	205	310	500	680	765
		Nominal strength	225	325	480	765	1,045	1,205
PPSD3S1016 PPSDQ3S1016	#10	ASD	80	128	194	315	425	480
		LRFD	128	205	310	500	680	765
		Nominal strength	225	325	480	765	1,045	1,205

1. Screws and connections have been tested per AISI Standard Methods S904-08 and S905-08.

2. Values are based on cold-formed steel (CFS) members with a minimum yield strength, F_y of 33 ksi and minimum tensile strength, F_u of 45 ksi for 43 mil (18 ga.) to 27 mil (22 ga.), and a minimum yield strength, F_y of 50 ksi and minimum tensile strength, F_u of 65 ksi for 54 mil (16 ga.) to 97 mil (12 ga.).

3. For design purposes, steel sheet thicknesses are 0.0283" for 27 mil (22 ga.), 0.0346" for 33 mil (20 ga.), 0.0451" for 43 mil (18 ga.), 0.0566" for 54 mil (16 ga.), 0.0713" for 68 mil (14 ga.) and 0.1017" for 97 mil (12 ga.). The actual sheet thickness shall not be less than 95% of these design thickness as specified in AISI S100, Section A2.4.

4. A minimum of three exposed screw threads are required to achieve the loads in the Table.

PPSD – Pull-Through Loads – Rated Sheathing Panels

Model No.	Screw Size	Load Description	Reference Pull-Through Loads (lb.)					
			Minimum Nominal Panel Thickness (in.)					
			Plywood			OSB		
			15/32	19/32	23/32	15/32	19/32	23/32
PPSD11516S0818 PPSDQ11516S0818	#8	ASD	83	84	116	49	109	117
		LRFD	179	181	250	106	235	255
		Nominal strength	415	420	580	245	545	585
PPSD134S1016 PPSDQ134S1016	#10	ASD	75	85	118	52	111	114
		LRFD	162	184	255	112	240	245
		Nominal strength	375	425	590	260	555	570
PPSD3S1016 PPSDQ3S1016	#10	ASD	75	85	118	52	111	114
		LRFD	162	184	255	112	240	245
		Nominal strength	375	425	590	260	555	570

1. The tabulated values are based on testing per AC233.

2. ASD pull-through loads based on a factor of safety of five applied to the nominal strength value ($C_D = 1.0$, increases to $C_D = 1.6$ allowed where applicable).

3. LRFD load based on adjustment of ASD load per NDS 2012, Appendix N using $K_F = 3.32$, $\phi_s = 0.65$, and $\lambda = 1.0$.

Load Tables, Technical Data and Installation Instructions

Strong-Drive® PHSD FRAMING-TO-CFS Screw

Common Applications:

- Cold-formed steel framing and sheet steel sheathing to cold-formed steel

Codes/Standards: ASTM C1513 compliant

For More Product Information, see p. 275

PHSD Screw – Cold-Formed Steel Member Connection Loads, Steel-to-Steel

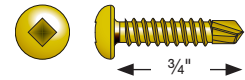

Model No.	Size	Nominal Dia. (in.)	Load Description	Shear (lb.)			Pull-Over (lb.)			Pull-Out (lb.)		
				Steel Thickness: mil (ga.) ⁶			Steel Thickness: mil (ga.) ⁶			Steel Thickness: mil (ga.) ⁶		
				27 (22)	33 (20)	43 (18)	27 (22)	33 (20)	43 (18)	27 (22)	33 (20)	43 (18)
PHSD34S0818	#8-18 x 3/4"	0.164	ASD load	181	235	305	220	345	390	67	125	133
			LRFD load	290	375	490	350	550	620	107	200	213
			Nominal strength	410	590	765	540	845	955	164	310	325

1. Screws and screw connections have been tested per AISI Standard Test Method S904-08 and S905-08. This screw is not recommended for 16 gauge and thicker steel. Provide a 1/8" diameter predrilled hole in 16 gauge and thicker steel, if this screw should be used.
2. The tabulated ASD and LRFD allowable loads for cold-formed steel (CFS) members are based on the lower of the screw strength or the strength of the screw in the connected members per AISI S100-2007 Section E4.
3. The safety factor is based on AISI S100-07 Chapter F for tested connections.
4. The average ultimate/nominal values listed should not be used for design loads.
5. Values are based on CFS members with a minimum yield strength of $F_y = 33$ ksi and tensile strength of $F_u = 45$ ksi for 43 mil (18 ga.) to 27 mil (22 ga.), minimum yield strength of $F_y = 50$ ksi and $F_u = 65$ ksi for 54 mil (16 ga.) to 97 mil (12 ga.).
6. For design purposes, steel sheet thicknesses are 0.0283" for 27 mil, 0.0346" for 33 mil, 0.0451" for 43 mil, 0.0566" for 54 mil, 0.0713" for 68 mil, and 0.1017" for 97 mil. The actual sheet thickness shall not be less than 95% of these design thickness as specified in AISI S100-07 Section A2.4.
7. Screw diameters per AISI S200-07 General Provision Commentary Table D1.1.
8. Minimum required screw length is the lesser of 3/4" or the minimum length required for the screw to extend through the steel connection a minimum of three exposed threads per AISI S200-07 General Provisions Standard Section D1.3.
9. Screw head or washer diameter, $d_w = 0.307$ ".
10. The allowable load (ASD) values shown are not permitted to be increased for short-duration loads such as wind or earthquake loads.
11. The lower of the pull-over and pull-out allowable load should be used for tension design.
12. The tabulated shear values are based on the thinner steel member in connection. Steel thickness for both members must be in the range of 12–22 gauge.
13. See general load tables on p. 287 for screw strength.

PHSD (#8) Screw – (Sheet Steel Sheathing-to-CFS) Nominal Shear Strength (R_n) for Wind (W) and Seismic (S) for Shear Walls¹ (lb./ft.)

Assembly Description	Max. Aspect Ratio (h/w)	Fastener Spacing at Panel Edges ² (in.)				Designation Thickness ⁵ of Stud, Track and Blocking ⁷ (mil)
		6	4	3	2	
0.018" sheet steel, one side	2:1	485 (W) 390 (S)	—	—	—	33 (min.)
	4:1	—	1,000	1,085	1,170	43 (min.)
0.027" sheet steel, one side	2:1 ³	647	710	778	845	33 (min.)
	4:1	970 (W) 780 (S)	—	—	—	33 (min.)
0.018" sheet steel, both sides	2:1	—	2,000	2,170	2,340	43 (min.)
	4:1	—	1,294	1,420	1,556	1,690

1. Nominal strength shall be multiplied by the resistance factor ($\phi = 0.6$, LRFD Seismic, $\phi = 0.65$, LRFD Wind) to determine design strength or divided by the safety factor ($\Omega = 2.5$, ASD Seismic, $\Omega = 2.0$, ASD Wind) to determine allowable strength.
2. Screws in the field of the panel shall be installed 12" (305 mm) on center (o.c.).
3. Shear wall height-to-width aspect ratio (h/w) greater than 2:1, but not exceeding 4:1, shall be permitted provided the nominal strength values are multiplied by 2w/h.
4. Wall studs and track shall be of ASTM A1003 Structural Grade 33 (Grade 230) Type H steel for members with a designation thickness of 33 and 43 mil.
5. In lieu of blocking, panel edges shall be permitted to be overlapped and attached to each other with screw spacing as required for panel edges. Where such a connection is used, tabulated design values shall be reduced 30%.
6. Maximum stud spacing 24" o.c.
7. Blocking, if applicable, shall be a minimum 33 mil, 1 1/2" width.
8. Table based on Table C2.1-1 AISI Standard *North American Standard for Cold-Form Steel Framing-Lateral Design 2007 Edition with Supplement No. 1 and Commentary*.

Load Tables, Technical Data and Installation Instructions

Strong-Drive® FPHSD FRAMING-TO-CFS Screw

Common Application:

Cold-formed steel framing and sheet steel sheathing to cold-formed steel

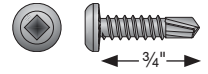
Codes/Standards: ASTM C1513 compliant, ICC-ES ESR-3006**For More Product Information,** see pp. 102, 275

FPHSD – Cold-Formed Steel Member Connection Loads, Steel-to-Steel

Model No.	Size	Nominal Dia. (in.)	Load Description	Shear (lb.)						Pull-Over (lb.)						Pull-Out (lb.)					
				Steel Thickness: mil (ga.)						Steel Thickness: mil (ga.)						Steel Thickness: mil (ga.)					
				27 (22)	33 (20)	43 (18)	54 (16)	68 (14)	97 (12)	27 (22)	33 (20)	43 (18)	54 (16)	68 (14)	97 (12)	27 (22)	33 (20)	43 (18)	54 (16)	68 (14)	97 (12)
FPHSD34S1016	#10-16 x 3/4"	0.190	ASD load	175	235	380	570	570	570	280	365	485	695	740	740	76	95	156	240	340	505
			LRFD load	280	375	605	855	855	855	445	585	775	1,110	1,110	1,110	123	151	250	380	545	805
			Nominal strength	395	535	860	1,305	1,305	1,305	685	895	1,190	1,705	2,215	2,215	190	230	385	585	840	1,235
FPHSD34S1214	#12-14 x 3/4"	0.216	ASD load	205	260	410	610	610	610	240	330	430	630	840	1,125	76	95	159	240	345	530
			LRFD load	330	420	650	975	975	975	390	530	685	1,005	1,340	1,690	123	151	255	385	550	855
			Nominal strength	485	610	930	1,385	1,385	1,385	595	815	1,050	1,540	2,060	2,065	190	230	390	590	845	1,295

- Screws and connections have been tested per AISI Standard Method S904-08 and S905-08.
- The tabulated ASD and LRFD allowable loads for cold-formed steel (CFS) members are based on the lower of the screw strength or the strength of the screw in the connected members per AISI S100-07 Section E4.
- Values are based on CFS members with a minimum yield strength of $F_y = 33$ ksi and tensile strength of $F_u = 45$ ksi for 43 mil (18 ga.) to 27 mil (22 ga.), minimum yield strength of $F_y = 50$ ksi and $F_u = 65$ ksi for 54 mil (16 ga.) to 97 mil (12 ga.).
- For design purposes, steel sheet thicknesses are 0.0283" for 27 mil, 0.0346" for 33 mil, 0.0451" for 43 mil, 0.0566" for 54 mil, 0.0713" for 68 mil, and 0.1017" for 97 mil. The actual sheet thickness shall not be less than 95% of these design thickness as specified in AISI S100-07 Section A2.4.
- Screw diameters per AISI S200-07 General Provision Commentary Table D1.1.
- Minimum required screw length is the lesser of 3/4" or the minimum length required for the screw to extend through the steel connection a minimum of three exposed threads per AISI S200-07 General Provisions Standard Section D1.3.
- Screw head d_w for #10 and #12 screws is 0.357".
- The allowable load (ASD) values shown are not permitted to be increased for short-duration loads such as wind or earthquake loads.
- The lower of the pull-over and pull-out allowable load should be used for tension design.
- The tabulated shear values are based on the thinner steel member in connection. Steel thickness for both members must be in the range of 12–22 gauge.
- See the general load tables on p. 287 for screw strength.

FPHSD (#10) Screw – (Sheet Steel Sheathing-to-CFS) Nominal Shear Strength (R_n) for Wind (W) and Seismic (S) for Shear Walls¹ (lb./ft.)

Assembly Description	Max. Aspect Ratio (h/w)	Fastener Spacing at Panel Edges ² (in.)				Designation Thickness ⁵ of Stud, Track and Blocking ⁷ (mil)
		6	4	3	2	
0.018" sheet steel, one side	2:1	485 (W) 390 (S)	—	—	—	33 (min.)
0.027" sheet steel, one side	4:1	—	1,000	1,085	1,170	43 (min.)
	2:1 ³	647	710	778	845	33 (min.)
0.018" sheet steel, both sides	2:1	970 (W) 780 (S)	—	—	—	33 (min.)
0.027" sheet steel, both sides	4:1	—	2,000	2,170	2,340	43 (min.)
	2:1 ³	1,294	1,420	1,556	1,690	33 (min.)

- Nominal strength shall be multiplied by the resistance factor ($\phi = 0.6$, LRFD Seismic, $\phi = 0.65$, LRFD Wind) to determine design strength or divided by the safety factor ($\Omega = 2.5$, ASD Seismic, $\Omega = 2.0$, ASD Wind) to determine allowable strength.
- Screws in the field of the panel shall be installed 12" (305 mm) on center (o.c.).
- Shear wall height-to-width aspect ratio (h/w) greater than 2:1, but not exceeding 4:1, shall be permitted provided the nominal strength values are multiplied by 2w/h.
- Wall studs and track shall be of ASTM A1003 Structural Grade 33 (Grade 230) Type H steel for members with a designation thickness of 33 and 43 mil.
- In lieu of blocking, panel edges shall be permitted to be overlapped and attached to each other with screw spacing as required for panel edges. Where such a connection is used, tabulated design values shall be reduced 30%.
- Maximum stud spacing 24" o.c.
- Blocking, if applicable, shall be a minimum 33 mil 1 1/2" width.
- Table based on Table C2.1-1 AISI Standard *North American Standard for Cold-Form Steel Framing-Lateral Design 2007 Edition with Supplement No. 1 and Commentary*.

Load Tables, Technical Data and Installation Instructions

Self-Drilling E Metal Screw

Common Application:

Cold-formed steel framing

- Recommended for use with certain Simpson Strong-Tie® connectors
- #3 drill point (Max. total drilling thickness 0.35")

Codes/Standards: ASTM C1513 compliant

For More Product Information, see p. 99

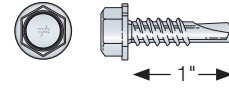

E – Screw Strength

Screw Size	Model No.	Nominal Strength (lb.)		Design Strength (LRFD) (lb.) $\phi = 0.5$		Allowable Strength (ASD) (lb.) $\Omega = 3.0$	
		P_{ss}	P_{ts}	ϕP_{ss}	ϕP_{ts}	P_{ss}/Ω	P_{ts}/Ω
#14 x 1"	E1B1414	3,130	5,395	1,565	2,700	1,045	1,800

E – Screw-to-Cold-Formed Steel Member Connection Loads, Steel-to-Steel

Screw Size	Model No.	Nominal Dia. (in.)	Washer Dia. (in.)	Load Description	Shear (lb.)					Pull-Over (lb.)					Pull-Out (lb.)				
					Steel Thickness: mil (ga.)					Steel Thickness: mil (ga.)					Steel Thickness: mil (ga.)				
					33 (20)	43 (18)	54 (16)	68 (14)	97 (12)	33 (20)	43 (18)	54 (16)	68 (14)	97 (12)	33 (20)	43 (18)	54 (16)	68 (14)	97 (12)
#14 x 1"	E1B1414	0.242	0.5	ASD	200	295	605	850	1,045	390	505	920	1,160	1,655	105	140	250	320	455
				LRFD	300	445	905	1,280	1,565	585	760	1,380	1,740	2,480	160	210	380	480	680
				Nominal strength	600	890	1,810	2,555	3,130	1,170	1,520	2,760	3,475	4,960	320	415	755	955	1,360

1. Screws shall extend through the connection with a minimum of three exposed threads per AISI General Provisions Standard Section D1.3.
2. Tabulated loads are based on calculations per AISI S100-07 using the thinner steel member in the connection. A safety factor of $\Omega = 3.0$ and resistance factor $\phi = 0.5$ were used to determine the ASD and LRFD strength values.

3. Loads are based on cold-formed steel members with a minimum yield strength, F_y , of 33 ksi and tensile strength, F_u , of 45 ksi for 43 mil (18 ga.) and thinner, and a minimum yield strength of 50 ksi and tensile strength of 65 ksi for 54 mil (16 ga.) and thicker.
4. For other pertinent information, please refer to the Important Information and General Notes pp. in the current Simpson Strong-Tie® *Cold-Formed Steel Connectors for Residential and Mid-Rise Construction* catalog.

Load Tables, Technical Data and Installation Instructions

PC/PCSD Screws

Cold-Formed Steel (CFS) Member Connection Loads

Model	Model No.	Size	Nominal Dia. ⁷ (in.)	Load Description	Shear (lb.)						Pull-Over (lb.)						Pull-Out (lb.)						
					Steel Thickness: mil (ga.) ⁶						Steel Thickness: mil (ga.) ⁶						Steel Thickness: mil (ga.) ⁶						
					27	33	43	54	68	97	27	33	43	54	68	97	22	27	33	43	54	68	97
					(22)	(20)	(18)	(16)	(14)	(12)	(22)	(20)	(18)	(16)	(14)	(12)	(24)	(22)	(20)	(18)	(16)	(14)	(12)
Pancake Head Screw – Metal Roofing-to-Steel																							
PCSD	PCSD1S1016	#10-16x1"	0.190	ASD ²	168	250	385	570	570	570	172	255	430	—	—	—	67	68	95	138	255	310	—
				Nominal load ⁴	420	570	875	1,475	1,645	1,690	420	735	1,220	—	—	—	171	166	235	340	630	760	—
PCSD	PCSD1S1214	#12-14x1"	0.216	ASD ²	156	295	420	585	585	585	210	320	505	—	—	—	66	66	88	129	255	320	—
				Nominal load ⁴	400	695	955	1,640	1,890	2,290	520	780	1,245	—	—	—	170	162	240	315	625	785	—
Pancake Head Screw – Metal Roofing-to-Wood (or light gauge CFS)																							
PC	PC1BS1012	#10-12x1"	0.190	ASD ²	290	345	—	—	—	—	170	255	475	—	—	—	—	—	106	136	—	—	—
				Nominal load ⁴	660	785	—	—	—	—	475	765	1,195	—	—	—	—	—	—	265	335	—	—
PC	PC1BS1211	#12-11x1"	0.216	ASD ²	320	390	—	—	—	—	200	300	450	—	—	—	—	—	113	151	—	—	—
				Nominal load ⁴	725	880	—	—	—	—	505	735	1,100	—	—	—	—	—	—	280	370	—	—

- Screws and screw connections have been tested per AISI Standard Test Method S904-08 and S905-08.
- The tabulated ASD loads for cold-formed steel (CFS) members are based on the lower of the screw strength or the strength of the screw in the connected members per AISI S100-07 Section E4.
- The safety factor is based on AISI S100-07 Chapter F for tested connections.
- The nominal load values listed are achieved under laboratory conditions and should not be used for design loads.
- Values are based on CFS members with a minimum yield strength of $F_y = 33$ ksi and tensile strength of $F_u = 45$ ksi for 43 mil (18 ga.) to 27 mil (22 ga.), minimum yield strength of $F_y = 50$ ksi and tensile strength of $F_u = 65$ ksi for 22 mil (24 ga.), and a minimum yield strength of $F_y = 50$ ksi and $F_u = 65$ ksi for 54 mil (16 ga.) and thicker.
- For design purposes, steel sheet thicknesses are 0.0227" for 22 mil, 0.283" for 27 mil, 0.0346" for 33 mil, 0.0451" for 43 mil, 0.0566" for 54 mil, 0.0713" for 68 mil, and 0.1017" for 97 mil. The actual sheet thickness shall not be less than 95% of these design thickness as specified in AISI S100-07 Section A2.4.
- Screw diameters per AISI S200-07 General Provision Commentary Table D1.1.
- Minimum required screw length is the lesser of $\frac{3}{4}$ " or the minimum length required for the screw to extend through the steel connection a minimum of 3 exposed threads per AISI S200-07 General Provisions Standard Section D1.3.
- Larger of screw head or washer diameter, d_w , for #10 and #12 screws is 0.375".
- The allowable load (ASD) values shown are not permitted to be increased for short-duration loads such as wind or earthquake loads.
- The lower of the Pull-Over and Pull-Out allowable load should be used for tension design.
- The tabulated shear values are based on the thinner steel member in connection. Steel thickness for both members must be in the range of 12–22 gauge.

Wood Member Connection Withdrawal Loads

Model	Model No.	Size	Nominal Diameter ⁵ (in.)	Load Description	Withdrawal (lb.)					
					Plywood			OSB		SYP
					$\frac{1}{2}$ "	$\frac{5}{8}$ "	$\frac{3}{4}$ "	$\frac{7}{16}$ "	$\frac{3}{4}$ "	2x
Pancake Head Screw – Metal Roofing to Wood										
PC	PC1BS1012	#10-12x1"	0.190	Allowable load ^{1,2}	55	55	60	33	51	117
				Average ultimate load ³	275	275	300	165	255	585
PC	PC1BS1211	#12-11x1"	0.216	Allowable load ^{1,2}	55	62	62	39	51	117
				Average ultimate load ³	275	310	310	194	255	585

- Values based on the lower screw strength or strength of the screw in the connected members.
- The tabulated allowable loads for wood members are based on factor of safety of 5 as specified in AC233, and $C_D=1.0$. Values may be multiplied by $C_D=1.6$ for wind or earthquake.
- The average ultimate loads are achieved under laboratory conditions and should not be used for design purposes.
- Screw diameters per AISI S200-07 General Provisions Commentary Table D1-1.
- See p. 287 for information on screw strength.

Load Tables, Technical Data and Installation Instructions

PCSD Standing-Seam-Roofing Panel Clip Screw

PCSD (#10) Screw – (Sheet Steel Sheathing-to-CFS)

Nominal Shear Strength (R_n) for Wind (W) and Seismic (S) for Shear Walls¹ (lb./ft.)^{1,4,6,8}

Assembly Description	Max. Aspect Ratio (h/w)	Fastener Spacing at Panel Edges ² (in.)				Designation Thickness ⁵ of Stud, Track and Blocking ⁷ (mil)
		6	4	3	2	
0.018" sheet steel, one side	2:1	485 (W) 390 (S)	—	—	—	33 (min.)
0.027" sheet steel, one side	4:1	—	1,000	1,085	1,170	43 (min.)
	2:1 ³	647	710	778	845	33 (min.)
0.018" sheet steel, both sides	2:1	970 (W) 780 (S)	—	—	—	33 (min.)
0.027" sheet steel, both sides	4:1	—	2,000	2,170	2,340	43 (min.)
	2:1 ³	1,294	1,420	1,556	1,690	33 (min.)

- Nominal strength shall be multiplied by the resistance factor ($\phi = 0.6$, LRFD Seismic, $\phi = 0.65$, LRFD Wind) to determine design strength or divided by the safety factor ($\Omega = 2.5$, ASD Seismic, $\Omega = 2.0$, ASD Wind) to determine allowable strength.
- Screws in the field of the panel shall be installed 12" (305 mm) on center (o.c.).
- Shear wall height to width aspect ratio (h/w) greater than 2:1, but not exceeding 4:1, shall be permitted provided the nominal strength values are multiplied by 2w/h.
- Wall studs and track shall be of ASTM A1003 Structural Grade 33 (Grade 230) Type H steel for members with a designation thickness of 33 and 43 mil.

- In lieu of blocking, panel edges shall be permitted to be overlapped and attached to each other with screw spacing as required for panel edges. Where such a connection is used, tabulated design values shall be reduced 30%.
- Maximum stud spacing 24" o.c.
- Blocking, if applicable, shall be a minimum 33 mil 1½" width.
- Table based on Table C2.1-1 AISI Standard *North American Standard for Cold-Form Steel Framing-Lateral Design 2007 Edition with Supplement No. 1 and Commentary*.

DWF/DWFSD Screws

Nominal Shear Strength (R_n) for Wind and Seismic Loads Shear Walls (Wind and Seismic Loads) Faced with ½" Gypsum Board (lb./ft.)¹⁻⁶

Assembly Description	Max. Aspect Ratio (h/w)	Fastener Spacing at Panel Edges/Field (in.)			
		7/7	4/4	4/12	8/12
½" gypsum board on one side of wall; steel studs max. 24" o.c.	2:1	290	425	295	230

- Nominal strength shall be multiplied by the resistance factor ($\phi = 0.6$ LRFD Seismic, $\phi = 0.65$ LRFD Wind) to determine design strength or divided by the safety factor ($\Omega = 2.5$ ASD Seismic, $\Omega = 2.0$ ASD Wind) to determine allowable strength.
- For gypsum sheathed shear walls, tabulated values shall be applicable for short-term load duration only (wind or seismic loads).
- Gypsum board shall comply with ASTM C1396.

- Gypsum board shall be applied horizontal with 33 mil strap blocking of 1½" width. In addition, solid blocking is required between the first two end studs. Alternatively, sheets may be applied vertically or values can be multiplied by 0.35.
- Studs and track shall be a minimum thickness of 33 mil.
- Table based on Table C2.1-2 AISI Standard *North American Standard for Cold-Form Steel Framing-Lateral Design 2007 Edition with Supplement No. 1 and Commentary*.

Load Tables, Technical Data and Installation Instructions

PPSD/CBSDQ/FHSD/WSFLRV Screws

For More Product Information,

- Strong-Drive® PPST Sheathing-to-CFS screw: see pp. 101, 276
- CBSAQ Sheathing screw: see p. 281
- FHSD Wood-to-CFS screw: see p. 283
- WSFLRV Wood-to-CFS/Aluminum screw: see p. 283

PPSD, CBSAQ, FHSD, WSFLRV Screw¹¹ – Nominal Shear Strength (R_n) for Wind and Other In-Plane Loads for Shear Wall^{1,4,6} (lb./ft.)

Assemble Description	Maximum Aspect Ratio (h/w)	Fastener Spacing at Panel Edges (in.)			
		6	4	3	2
1½" structural 1 sheathing (4-ply), one side	2:1	1065 ³	—	—	—
7/16" rated sheathing (OSB), one side	2:1	9,10 ³	1,410	1,735	1,910
7/16" rated sheathing (OSB), one side oriented perpendicular to framing	2:1	1,020	—	—	—
7/16" rated sheathing (OSB), one side	2:1 ⁵	—	1,025	1,425	1,825

- Nominal strength shall be multiplied by the resistance factor ($\phi = 0.65$) to determine the design strength or divided by the safety factor ($\Omega = 2.0$) to determine the allowable strength.
- Screws in the field of the panel shall be installed 12" (305 mm) on center (o.c.).
- Where fully blocked gypsum board is applied to the opposite side of this assembly, per Table C2.1-2 AISI Standard *North American Standard for Cold-Formed Steel Framing — Lateral Design 2007 Edition with Supplement No. 1 and Commentary* with screw spacing at 7" (178 mm) o.c. edge and 7" (178 mm) o.c. field, these nominal strengths are permitted to be increased by 30%.
- For walls with material of the same type and nominal strength applied to opposite faces of the same wall, the available strength of material of same capacity is cumulative. Where the material nominal strengths are not equal, the available strength shall be either two times the available strength of the material with the smaller value or shall be taken as the value of the stronger side, whichever is greater. Summing the available strengths of dissimilar material applied to opposite faces or to the same wall line is not allowed.
- Shear wall height to width aspect ratio (h/w) greater than 2:1, but not exceeding 4:1, shall be permitted provided the nominal shear strength is multiplied by 2w/h.
- For wood structural panel sheathed shear walls, tabulated R_n values shall be applicable for short-term load duration (wind loads). For other in-plane lateral loads of normal or permanent load duration as defined by the AWC NDS, the values in the table above for wood structural panel sheathed shear walls shall be multiplied by 0.63 (normal) or 0.56 (permanent).
- Maximum stud spacing 24" o.c.
- All sheathing edges shall be attached to framing or 1½" width 33 mil blocking.
- Table based on Table C2.1-1 AISI Standard *North American Standard for Cold-Form Steel Framing — Lateral Design 2007 Edition with Supplement No. 1 and Commentary*.
- See General Load Table on p. 287 for screw strength.
- #8 screws — PPST, CBSAQ, FHSD, WSFLRV. #10 screws — FHSD.
- Stud, track and blocking (if applicable) shall be a minimum of 33 mil.

PPSD, CBSAQ, FHSD, WSFLRV Screw¹² – Nominal Shear Strength (R_n) for Seismic and Other In-Plane Loads for Shear Wall^{1,4,7} (lb./ft.)

Assemble Description	Maximum Aspect Ratio (h/w)	Fastener Spacing at Panel Edges ² (in.)				Designation Thickness ^{5,6} of Stud, track and Blocking (mil)	Required Sheathing Screw Size
		6	4	3	2		
1½" structural 1 sheathing (4-ply), one side	2:1 ³	780	990	—	—	33 or 43	8
	2:1	890	1,330	1,775	2,190	43	10
7/16" rated sheathing (OSB), one side	2:1 ³	700	915	—	—	68	8
	2:1 ³	825	1,235	1,545	2,060	48	8
	2:1	940	1,410	1,760	2,350	54	8
	2:1	1,232	1,848	2,310	3,080	68	10

- Nominal strength shall be multiplied by the resistance factor ($\phi = 0.60$) to determine the design strength or divided by the safety factor ($\Omega = 2.5$) to determine the allowable strength.
- Screws in the field of the panel shall be installed 12" (305 mm) on center (o.c.).
- Shear wall height to width aspect ratio (h/w) greater than 2:1, but not exceeding 4:1, shall be permitted provided the nominal shear strength is multiplied by 2w/h.
- For walls with material of the same type and nominal strength applied to opposite faces of the same wall, the available strength of material of same capacity is cumulative. Where the material nominal strengths are not equal, the available strength shall be either two times the available strength of the material with the smaller value or shall be taken as the value of the stronger side, whichever is greater. Summing the available strengths of dissimilar material applied to opposite faces or to the same wall line is not allowed.
- Substitution of a stud or track of a different designation thickness is not permitted.
- Wall studs and track shall be of ASTM A1003 Structural Grade 33 (Grade 230) Type H steel for members with a designation thickness of 33 and 43 mil, and A1003 Structural Grade 50 (Grade 340) Type H steel for members with a designation thickness equal to greater than 54 mil.
- For wood structural panel sheathed shear walls, tabulated R_n values shall be applicable for short-term load duration (seismic loads). For other in-plane lateral loads of normal or permanent load duration as defined by the AF&PA NDS, the values in the table above for wood structural panel sheathed shear walls shall be multiplied by 0.63 (normal) or 0.56 (permanent).
- Maximum stud spacing 24" o.c.
- All sheathing edges shall be attached to framing or 1½" width 33 mil blocking.
- Table based on Table C2.1-3 AISI Standard *North American Standard for Cold-Formed Steel Framing — Lateral Design 2007 Edition with Supplement No. 1 and Commentary*.
- See General Load Table on p. 287 for screw strength.
- #8 screws — PPST, CBSAQ, FHSD, WSFLRV. #10 screws — FHSD.

Load Tables, Technical Data and Installation Instructions

Steel-Deck Fastening

Steel decks may be classified into roof decks, form decks and composite decks. The primary purpose of these decks is to support vertical loads, but they can also be used as a horizontal diaphragm to resist lateral loads from wind or earthquake forces. The strength of the diaphragm can be limited by fastener connection strength, local panel buckling, or even plate buckling of the entire diaphragm.

Steel-deck panels are available in different geometries and thicknesses and steel properties from different manufacturers. Common deck panel profiles are narrow rib (NR, commonly referred to as Type A deck), intermediate rib (IR, commonly referred to as Type F deck) and wide rib (WR, commonly referred to as Type B deck). Illustrations of these can be found in SDI publications. The SDI design recommendations are limited to deck panels that are in the thickness range of 0.014" to 0.064", and panel depths $\frac{3}{16}$ " to 3".

Steel-deck fastening is categorized into two groups – structural fastening and side-lap or stitch fastening. Structural fasteners connect the steel deck panels to the structural framing, while side-lap fasteners connect the panels together along the free edges between the supports. The most important information for any steel deck fastener is the connection strength and connection flexibility that is developed using the fastener.

Steel-Deck Fastening

Based on the deck profile, width and the design load, a structural fastening pattern and the number of side-lap fasteners or side-lap spacing can be determined. The fastening pattern provides the number of structural fasteners needed to attach the decking panel to support steel. The structural fastening pattern is given by the deck width followed by the number of fasteners. e.g., 36/7 pattern means 36" wide panel attached with seven fasteners. The most typical fastener patterns for steel deck profiles are shown here.

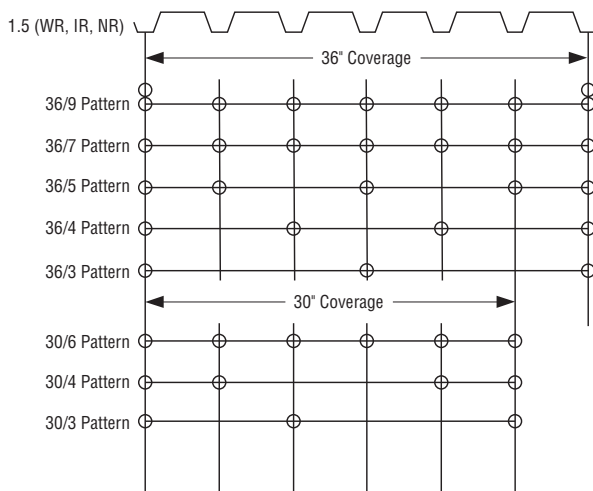

Typical Fastener Layout

(From SDI, DDM03 2004, 3rd Edition, Appendix IV; DDM04 2015, 4th Edition)

The number of side-lap fasteners required at the over-lapping panel edges are per deck span between structural supports. For example, five side laps for a 6' deck span would represent six even spaces with side-lap fasteners at 12" on center. The side-lap fastener spacing can range between 3" and 36" o.c.

Structural fastening can be done with puddle welds, power-actuated pins, or screws. Each type of fastening has its advantages and disadvantages in terms of installation cost, installation effort, capacity, energy dissipation and behavior at ultimate load. All of the fasteners would be called out in a fastener pattern using nomenclature similar to that shown in the figure.

Load Tables, Technical Data and Installation Instructions

Steel-Deck Fastening (cont.)

Evaluation Reports and Approvals

Steel-deck diaphragms can be designed and constructed following code-recognized design procedures and provisions. At the same time, the codes provide for alternate design methods and materials to be recognized by the authority having jurisdiction. Some deck and fastener manufacturers have gone the alternate route and in that process have secured evaluation reports that can be used by the engineering design community for design of steel diaphragms and by the local building officials as the basis for approval. ICC-ES and IAPMO UES provide criteria that can be used to secure evaluation reports for steel diaphragm products.

The insurance industry also has a form of compliance that it uses as the basis for risk management. Factory Mutual (FM) provides an Approval for deck products and systems as well as fasteners used for fastening the deck panels.

Simpson Strong-Tie Steel-Deck Fasteners

Simpson Strong-Tie holds evaluation reports and FM Approvals for all of its steel deck diaphragm fasteners. These reports and approvals are available on line at no cost from the issuing agency or at strongtie.com.

The Simpson Strong-Tie self-tapping X metal screws have been qualified for compliance with ASTM C1513 and some of these screws are included in the SDI DDM03 and DDM04, Appendix VII and Appendix IX. In those documents, diaphragm design values are provided in tabular format for typical fastening patterns and for a range of common deck thicknesses. The SDI DDM03 and DDM04 manuals are code-referenced documents.

In addition, the strength and flexibility of connections with Simpson Strong-Tie X-series screws used in steel decks were evaluated per IAPMO UES Evaluation Criteria EC007 (2013), which is based on AISI S310, North American Standard for the Design of Profiled Steel Panels. The connection strengths and flexibilities can be used to calculate the nominal diaphragm shear strength and diaphragm stiffness per Sections 2 and 3 of SDI DDM03.

The Simpson Strong-Tie steel deck diaphragm calculator, which is available as a web app, can be used to do the diaphragm strength and stiffness calculations, investigate alternative fastening strategies and ultimately produce the required submission documents.

The available Simpson Strong-Tie fasteners for steel-deck applications are listed on pp. 98 and 278 of this catalog. They are available in bulk or collated forms. The collated forms are driven using Quik Drive® Systems. For more up-to-date information on steel deck diaphragm fasteners, evaluation reports, approvals and appropriate Quik Drive tools including some products not found in the print catalog, see strongtie.com.

Load Tables, Technical Data and Installation Instructions

Strong-Drive® SELF-DRILLING X METAL Screw

Common Application:

Steel decking-to-structural steel cold-formed steel framing and steel stitching

Codes/Standards: ICC-ES ESR-3006, City of LA RR25670 and RR25917, RR26009, ASTM C1513 compliant, IAPMO UES ER326, FM Approval #3045651, SDI DDM03, Appendix VII, IAPMO-UES ER-326, SDI DDM04, State of Florida FL16937

For More Product Information, see pp. 98, 278

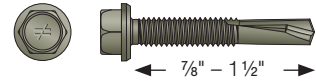

X Metal Screw – Cold-Formed Steel Connection Loads

Model No.	Size	Nominal Dia. (in.) ⁷	Load Description	Shear (lb.)								Pull-Over (lb.)						Pull-Out (lb.)								
				Steel Thickness: mil (ga.)								Steel Thickness: mil (ga.)						Steel Thickness: mil (ga.)								
				27	33	43	54	68	97	1/8 ¹¹²	1/4 ¹¹²	27	33	43	54	68	97	27	33	43	54	68	97	3/16 ¹¹²	1/4 ¹¹²	1/2 ¹¹²
XQ1S1016 X1S1016	#10-16x3/4"	0.190	ASD	175	235	360	540	540	540	—	—	330	400	475	645	925	975	71	87	129	200	270	445	—	—	—
			LRFD	280	375	570	810	810	810	—	—	525	640	755	1,035	1,465	1,465	114	139	205	320	430	715	—	—	—
	Nominal strength		400	535	815	1,290	1,290	1,290	—	—	805	990	1,160	1,585	2,260	2,695	174	215	315	490	660	1,095	—	—	—	
XQ1S1214 X1S1214	#12-14x1"	0.216	ASD	176	235	385	595	840	840	—	—	295	375	525	785	1,045	1,210	74	96	147	215	325	500	—	—	—
			LRFD	280	375	610	950	1,265	1,265	—	—	470	600	835	1,255	1,670	1,875	117	154	235	340	520	795	—	—	—
	Nominal strength		400	535	870	1,350	2,135	2,135	—	—	720	920	1,285	1,925	2,565	2,965	180	235	360	520	800	1,220	—	—	—	
XQ114S1224	#12-24x1 1/4"	0.216	Nominal strength	420	550	920	1,455	1,675	2,675	2,675	2,675	795	875	985	1,770	1,930	3,400	235	205	280	505	640	1,130	1,990	3,370	4,260
XQ112S1224	#12-24x1 1/2"			420	550	920	1,455	1,675	2,675	2,675	2,675	795	875	985	1,770	1,930	3,400	235	205	280	505	640	1,130	1,990	3,370	4,260

1. Screws and screw connections have been tested per AISI Standard Test Method S904-08 and S905-08 with the exception of 22 gauge values which are based on calculations of the AISI S100-07 Section E4.
2. The tabulated ASD and LRFD allowable loads for cold-formed steel (CFS) members are based on the lower of the screw strength or the strength of the screw in the connected members per AISI S100-07.
3. The safety factor Ω and resistance factor ϕ used to determine the ASD and LRFD strength are based on AISI S100-2007 Section F.
4. The nominal strength values listed are achieved under laboratory conditions and should not be used for design loads.
5. Values are based on CFS members with a minimum yield strength of $F_y = 33$ ksi and tensile strength of $F_u = 45$ ksi for 43 mil (18 ga.) to 27 mil (22 ga.), minimum yield strength of $F_y = 50$ ksi and $F_u = 65$ ksi for 54 mil (16 ga.) to 97 mil (12 ga.), and a minimum yield strength of $F_y = 36$ ksi and $F_u = 58$ ksi for 1/8" and thicker.
6. For design purposes, steel sheet thicknesses are 0.0283" for 27 mil, 0.0346" for 33 mil, 0.0451" for 43 mil, 0.0566" for 54 mil, 0.0713" for 68 mil, and

- 0.1017" for 97 mil. The actual sheet thickness shall not be less than 95% of these design thickness as specified in AISI S100-7 Section A2.4.
7. Screw diameters per AISI S207-07 General Provisions Commentary Table D1-1.
8. Minimum required screw length is the lesser of 3/4" or the minimum length required for the screw to extend through the steel connection a minimum of 3 exposed threads per 2004 AISI General Provisions Standard section D1.3.
9. Screw head or washer diameter, dw, for #10 and #12 screws is 0.398".
10. The allowable load (ASD) values showing are not permitted to be increased for short duration loads such as wind or earthquake loads.
11. The lower of the pull-over and pull-out allowable load should be used for tension design.
12. The tabulated shear values are based on the thinner steel member in connection. Steel thickness for both member must be in the range of 1/2" - 22 gauge.
13. The XQ-S1224 screws are recommended for 16 gauge and thicker steel.
14. See p. 287 for information on screw strength.

C-F-2017 © 2017 SIMPSON STRONG-TIE COMPANY INC.

Load Tables, Technical Data and Installation Instructions

Strong-Drive® XL LARGE-HEAD and XM MEDIUM-HEAD METAL Screws

High-Performance Screw Alternative to Welds and Pins

Strong-Drive® metal screws are load-tested and code-listed, allowing you to get the maximum load values for installation. Strong-Drive® XL Large-Head Metal screws are the perfect choice when high shear or uplift resistance is required. Strong-Drive® XM Medium-Head Metal screws, with their ½" washer head, are designed for narrow flutes commonly found on interlocking deck profiles. In high-strength decks ($F_y = 50$ ksi), these screws are excellent 1-for-1 replacements for pins. The Self-Drilling X Metal screw is your go-to screw for lighter-duty support fastening and stitching applications. These screws are available in bulk or collated for Quik Drive® steel-decking systems.

Simpson Strong-Tie provides a full offering of code-listed fasteners for your next steel-decking job.

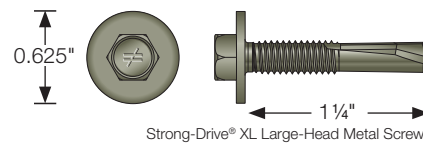

Strong-Drive® XL Large-Head Metal Screw

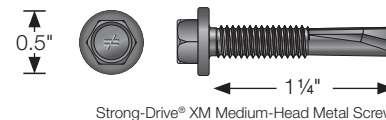

Strong-Drive® XM Medium-Head Metal Screw

Strength in Numbers

Comparison testing shows that Strong-Drive XL Large-Head Metal screws and Strong-Drive XM Medium-Head Metal screws are stronger than many alternative fastener types in 33 ksi and 50 ksi steel decking.

For Standard SDI DDM03 and DDM04 Decks with $F_y = 33$ ksi

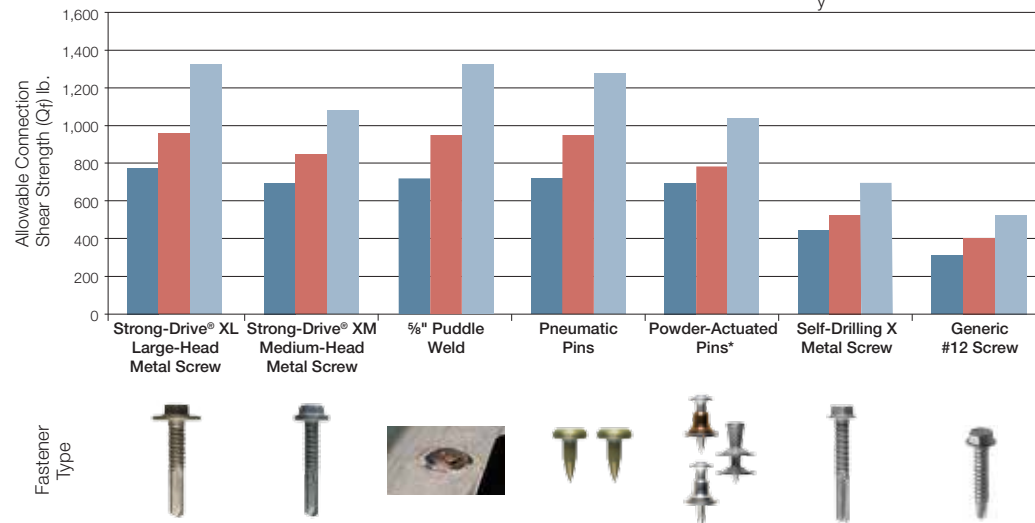

Wind Load

- Standard screw based on AISI Eq.
- PAF values based on SDI DDM03 and DDM04 Manuals
- Values based on ¼" support thickness
- Safety factors per DDM03 and DDM04

*Average

For Proprietary Steel Decks with $F_y = 50$ ksi

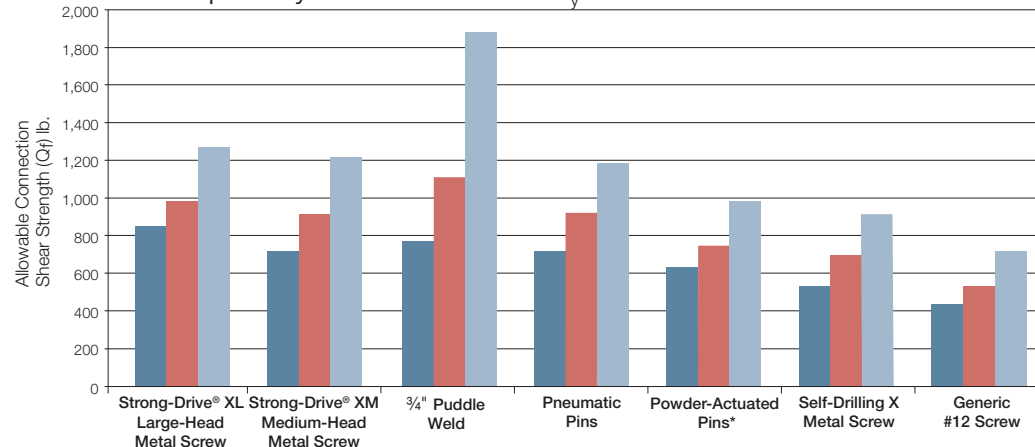

Seismic Load

- Standard screw based on AISI Eq.
- PAF values based on SDI DDM03 and DDM04 Manuals
- Values based on ¼" support thickness
- Safety factors per DDM03 and DDM04

*Average

Load Tables, Technical Data and Installation Instructions

Strong-Drive®

XL LARGE-HEAD

and XM MEDIUM-HEAD METAL Screws (cont.)

Screw Shear and Tension Strengths

Model	Size	Model Numbers	Nominal Dia. (in.)	Washer Dia. (in.)	Nominal	
					Shear (lb.)	Tension (lb.)
					P _{ss}	P _{ts}
Strong-Drive® XL Large-Head Metal Screw	#12 x 1¼"	XLQ114T1224, XLQ114B1224-2K	0.216	0.625	3,110	4,985
Strong-Drive® XM Medium-Head Metal Screw	#12 x 1¼"	XMQ114S1224, XMQ114B1224-2K	0.216	0.483		
Self-Drilling X Metal Screw	#12 x 1¼"	XQ114S1224, XQ114B1224-2.5K	0.216	0.415		
Self-Drilling X Metal Screw	#12 x 1½"	XQ112S1224, XQ112B1224-2K	0.216	0.415		
Self-Drilling X Metal Screw	#10 x ¾"	X34B1016-5K	0.190	0.415	1,625	—
Self-Drilling X Metal Screw	#10 x 1"	X1S1016, XQ1S1016, X1B1016-4K, XQ1B1016-4K	0.190	0.415	1,625	—
Self-Drilling X Metal Screw (undersized drillpoint)	#10 x ¾"	XU34S1016, XU34B1016-5K	0.190	0.475	1,735	—

1. P_{ss} and P_{ts} are nominal shear strength and nominal tension strength for the screw itself, respectively, and are the average (ultimate) value of all tests determined by independent laboratory testing.
2. The ASD and LRFD loads for tension are calculated using a safety factor Ω of 3.0 and the resistance factor ϕ of 0.5, respectively.
3. For tension connection: the smallest of the screw tension strength, pull-over strength and pull-out strength shall be used for design.

Structural Screw Pull-Over Strength with Steel Minimum Yield Strength F_y = 33 ksi

Model	Size	Model Numbers	Load Type	Pull-Over Loads (lb.)			
				Deck Thickness, ga (in.)			
				22 (0.0295)	20 (0.0358)	18 (0.0474)	16 (0.0598)
Strong-Drive® XL Large-Head Metal Screw ²	#12 x 1¼"	XLQ114T1224 XLQ114B1224-2K	Nominal	1,295	1,705	2,490	2,775
			LRFD	840	1,100	1,625	1,810
			ASD	525	690	1,015	1,135
Strong-Drive® XM Medium-Head Metal Screw ²	#12 x 1¼"	XMQ114S1224 XMQ114B1224-2K	Nominal	750	1,020	1,400	1,930
			LRFD	485	655	915	1,260
			ASD	305	415	570	790
Self-Drilling X Metal Screw ⁴	#12 x 1¼"	XQ114S1224, XQ114B1224-2.5K	Nominal	825	1,005	1,330	1,675
	#12 x 1½"	XQ112S1224, XQ112B1224-2K	LRFD	415	500	665	840
			ASD	275	335	445	560

1. Values are based on steel members with a minimum yield strength of F_y = 33 ksi and tensile strength of F_u = 45 ksi.
2. The values for 16 ga, 18 ga, 20 ga and 22 ga are based on tests per AISI Standard Test Method S905-08.
3. The safety factor Ω and resistance factor ϕ used to determine the ASD and LRFD strengths are based on AISI S100, Chapter F.
4. The values for 16 ga, 18 ga, 20 ga and 22 ga are based on the calculations per AISI S100-07, Section E4.
5. For tension connection: the smallest of the screw tension strength, pull-over strength and pull-out strength shall be used for design.

Structural Screw Pull-Out Strength

Model	Size	Model Numbers	Load Type	Pull-Out Loads (lb.)			
				Support Thickness			
				½"	¾"	1"	1½"
Strong-Drive® XL Large-Head Metal Screw	#12 x 1¼"	XLQ114T1224, XLQ114B1224-2K	Minimum Tensile Strength of Steel, F _u = 65 ksi				
			Nominal	1,490	2,240	2,985	4,475
			LRFD	745	1,120	1,490	2,240
Strong-Drive® XM Medium-Head Metal Screw	#12 x 1¼"	XMQ114S1224, XMQ114B1224-2K	ASD	495	745	995	1,490
			Minimum Tensile Strength of Steel, F _u = 50 ksi				
			Nominal	1,150	1,720	2,295	3,445
Self-Drilling X Metal Screw	#12 x 1¼"	XQ114S1224, XQ114B1224-2.5K	LRFD	575	860	1,150	1,720
	#12 x 1½"	XQ112S1224, XQ112B1224-2K	ASD	385	575	765	1,150

1. Values are based on calculations per Section E4 of AISI S100-07.
2. The tabulated ASD and LRFD loads are based upon a safety factor Ω of 3.0 and the resistance factor ϕ of 0.5.
3. For tension connection: the smallest of the screw tension strength, pull-over strength and pull-out strength shall be used for design.

For more information regarding these tables, please refer to IAPMO UES ER-326.

Load Tables, Technical Data and Installation Instructions

Steel Deck Diaphragm Calculator

The Steel Deck Diaphragm Calculator web app offers optimized steel deck design solutions based on fastener and labor costs for a given shear and uplift. It can provide calculations for any solution generated. Generate diaphragm tables for various roof and floor decks using Simpson Strong-Tie® fasteners. The app can also generate a submittal package that includes fastener information, code reports, Factory Mutual reports, Appendix VII and IX of DDM03 (also reference DDM04), coating information and tools for installation. The app is accessible from any web browser and does not require downloading or installing special software. Users can:

- Design for multiple zones and develop solutions in either ASD or LRFD
- Modify deck properties from the standard properties listed in SDI DDM03 and DDM04
- Generate multiple cost- and labor-optimized solutions with calculations included
- Generate tables in Nominal, ASD Wind, LRFD Wind, ASD Seismic or LRFD Seismic
- Design for loads using the new Strong-Drive® XL Large-Head Metal screw (included in the optimization calculator)
- Design for additional structural patterns not covered in SDI literature
- Access proprietary deck tables with the new Strong-Drive® XM Medium-Head Metal screw

Steel Deck Diaphragm Load Tables for Interlocking Decks

Load tables are available on our website application for using Strong-Drive XM Medium-Head Metal screws on frequently used interlocking decks with proprietary side-lap connections.

For more information regarding Strong-Drive XM Medium-Head Metal screw shear tables, refer to strongtie.com/diaphragmcalc.

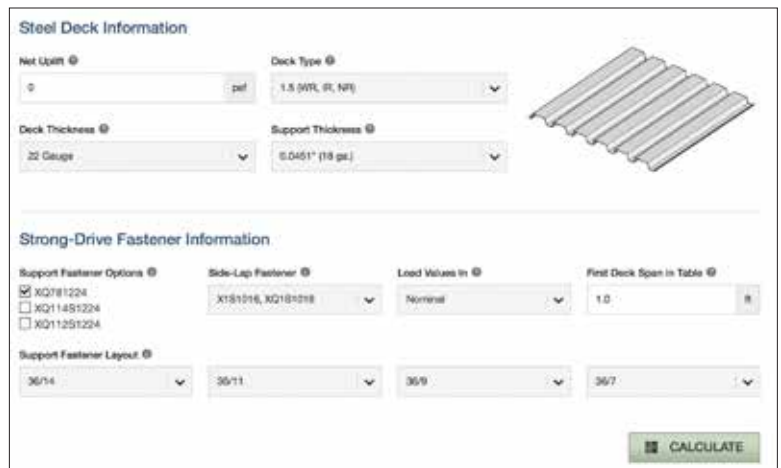
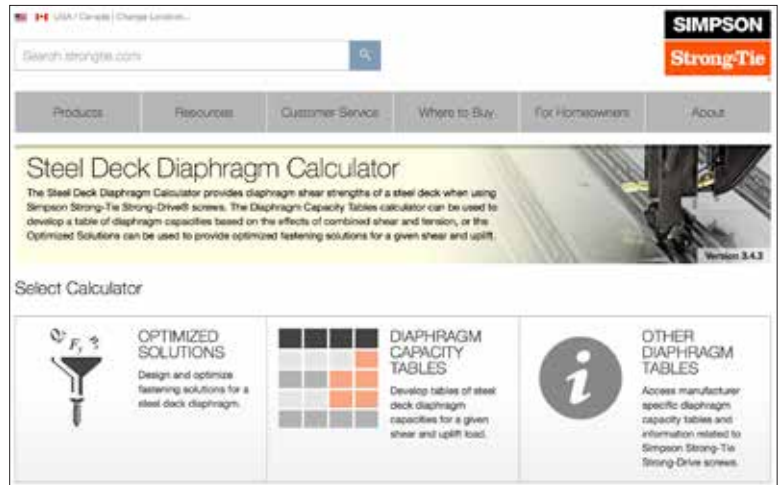

Example of Steel Deck Diaphragm Calculator Web Application

STEEL DECK DIAPHRAGM CALCULATOR

DIAPHRAGM SHEAR STRENGTH TABLES: 0.0451" (18 ga.) SUPPORT STEEL THICKNESS

1.5 (WR, IR, NR) x 22 Gauge (t = design thickness = 0.0295)

Support Fasteners: XQ2181224, XQ11451224, XQ11251224
 Side-Lap Fasteners: X1S1016, XQ1S1018

φ (EQ): 0.65 φ (EQ): 2.50
 φ (Wind): 0.75 φ (Wind): 2.25
 φ (Other): 0.85 φ (Other): 2.50

Click on a shear strength or KI value in the table below to view and print specific calculations.

Support Fastener Layout	Side Lap Fasteners Per Span	Nominal Shear Strength (qf)										KI	
		Deck Span (ft)											
		1.0	1.5	2.0	2.5	3.0	3.5	4.0	4.5	5.0	5.5	6.0	
36/14	0	2025	2311	1871	1567	1229	1158	1024	881	798			0.279
	1	3103	2818	3088	2787	1890	1301	1332	1018	812	624	732	0.238
	2	3248	3093	3248	1808	1845	1441	1280	1350	1002	692	850	0.207
	3	3382	2842	2412	2082	1791	1579	1404	1264	1148	1080	948	0.195
	4	2437	2880	3336	2208	1929	1720	1524	1379	1241	1188	1041	0.198
	5	3530	3090	3057	2042	2058	1828	1628	1483	1381	1241	1168	0.191
	6	3600	3180	2808	2408	2181	1945	1758	1587	1449	1382	1282	0.198
	7	3654	3281	3011	2380	2298	2007	1808	1687	1541	1421	1318	0.178
8	3738	3352	3008	2884	2492	2192	1958	1784	1648	1548	1448	0.178	

Example of Steel Deck Diaphragm Load Table for Interlocking Decks



Deck-Drive™ DCU COMPOSITE Screw

**Decking meets
its match.**



Alphabetical Index

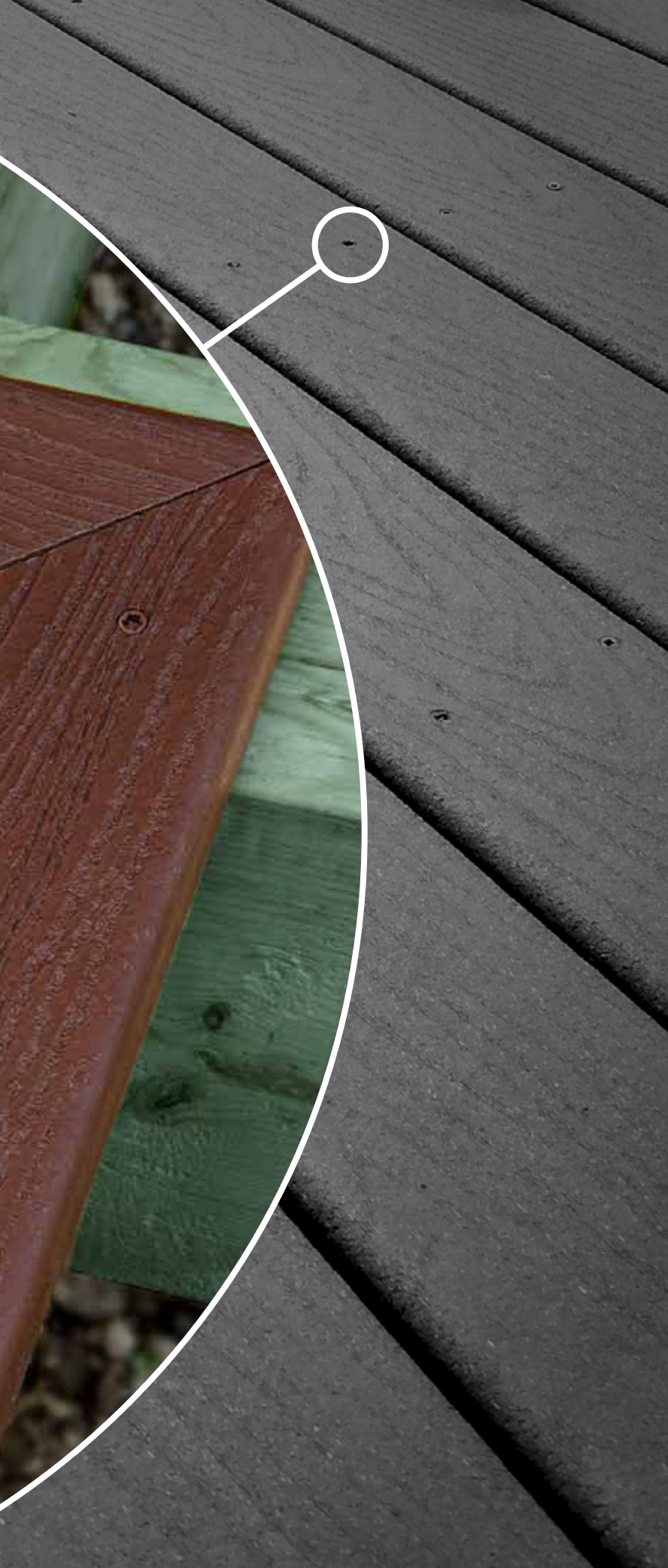

Alphabetical Index

0-9

8DBRPT2500.....	158
8DHDGPT500.....	158
8DHDGPT2500.....	158
10D.....	139
10D5HDG-R.....	139
10DHDG-R.....	139
16D.....	139, 307
16D5HDG-R.....	139
16DHDG-R.....	139
100-EBTYJR.....	155
100-EBTYLC.....	155
100-EBTYMI.....	155
100-EB TYS.....	155
175-EB162.....	155
175-EBAOSQ.....	155
175-EB TT.....	155
175-EBTYBG.....	155
175-EBTYJR.....	155
175-EBTYLC.....	155
175-EBTYMI.....	155
175-EBTYP.....	155
175-EB TYS.....	155
175-EB TYW.....	155
275-EB TYS.....	155
316-TT.....	155
512050EP18.....	140
512075EP18.....	140
514075EP18.....	140
514100EP18.....	140
514125EP18.....	140
514150EP18.....	140
516037EP18.....	140
516050EP18.....	140
516062EP18.....	140
516075EP18.....	140
516100EP18.....	140
518037EP18.....	140
518050EP18.....	140
518075EP18.....	140
518100EP18.....	140

A

A12A187DNB.....	160
A39ARNB.....	131
A49RN1.....	132
A49RN5.....	132
A49RNB.....	132
A211ARN5.....	131
A211ARNB.....	131
A211RNB.....	132
A311ARN1.....	131
A311ARN5.....	131
A311ARNB.....	131
A311RN1.....	132
A311RNB.....	132
A411ARNB.....	131
ADM31DG2.....	247

B

B12050EP18.....	140
B12075EP18.....	140
B14050EP5.....	140
B14075EP1.....	140
B14125EP1.....	140
B14150EP1.....	140
B16050EP1.....	140
B16062EP1.....	140
B16075EP1.....	140
B16075EP5.....	140
B16100EP1.....	140
B16100EP5.....	140
B16125EP1.....	140
B16125EP5.....	140
B18050EP1.....	140
B18050EP18.....	140
B18075EP18.....	140
B18100EP18.....	140
BIT1S-2-RC3.....	111
BIT2P.....	248
BIT2P-RC3.....	248
BIT2P-RC10.....	248
BIT2S.....	248
BIT2S-2-RC3.....	111
BIT2S-RC3.....	248
BIT2S-RC10.....	248
BIT2SU.....	248
BIT2SU-2-RC3.....	111
BIT2SU-RC3.....	248
BIT2SU-RC10.....	248
BIT3S.....	248
BIT3S-2-RC3.....	111
BIT3S-RC3.....	248
BIT3S-RC10.....	248
BIT3SU.....	248
BIT3SU-2-RC3.....	111
BIT3SU-RC3.....	248
BIT3SU-RC10.....	248
BIT15T-2-RC3.....	111
BIT20T-2-RC3.....	111
BIT25T-2-RC3.....	111
BIT27T-2-RC3.....	111
BIT30T-2-RC3.....	111
BIT40T-134-RC3.....	111
BITHEX516.....	248
BITHEXLB14.....	239, 248
BITHEXLB516.....	248
BITHEXLB516LG... ..	218, 230, 235, 242, 248
BITHEXR12-134.....	71, 111
BITHEXR38-134.....	72, 75, 99, 111, 329
BITHEXR516-134... ..	70, 71, 95, 97, 98, 111
BITKEY.....	248
BITTX20.....	248
BITTX20-RC3.....	248
BITTX20-RC10.....	248
BITTX25.....	248
BITTX25-RC3.....	248
BITTX25-RC10.....	248
BOA1G2.....	247

BPHLXBGGP516G2.....	248
BPHX14G2.....	226
BPHX516G2.....	240, 248, 250
BPHXLB14G2.....	239
BPHLXBGGP14G2.....	219, 235, 248, 250
BPHLXBGGP516G2.....	218, 219, 235, 248, 250
BPHLXBPPG2.....	231, 243, 248, 250
BPHLXBSDG2.....	230, 242, 250
BPHLXBSG2.....	248
BPHLXBGGP516G2.....	248

C

C10TNB.....	134
C16HATNB.....	133
C16HTNB.....	134
C16TNB.....	134
C40TNB.....	134
C210ARN1.....	131
C210ARN5.....	131
C210ARNB.....	131
C210RN1.....	132
C210RN5.....	132
C210RNB.....	132
C211ARN1.....	131
C211ARN5.....	131
C211ARNB.....	131
C211RN1.....	132
C211RN5.....	132
C211RNB.....	132
C310ARN1.....	131
C310ARN5.....	131
C310ARNB.....	131
C310RN1.....	132
C310RN5.....	132
C310RNB.....	132
C311ARN1.....	131
C311ARN5.....	131
C311ARNB.....	131
C311RN1.....	132
C311RN5.....	132
C311RNB.....	132
C410ARN1.....	131
C410ARN5.....	131
C410ARNB.....	131
C410RN1.....	132
C410RN5.....	132
C410RNB.....	132
C411ARN1.....	131
C411ARN5.....	131
C411ARNB.....	131
C411RN1.....	132
C411RN5.....	132
C411RNB.....	132
C510ARN1.....	131
C510ARN5.....	131
C510ARNB.....	131
C510RN1.....	132
C510RN5.....	132
C510RNB.....	132
C511ARN1.....	131

Alphabetical Index

C511ARN5	131	DCU234BR01MB	89	DCU234RDR350	89
C511ARNB	131	DCU234BR01R350	89	DCU234S305	265
C511RN1	132	DCU234BR05MB	89	DCU234S316	265
C511RN5	132	DCU234BR05R350	89	DCU234S316BR01	265
C511RNB	132	DCU234GR01MB	89	DCU234S316BR05	265
C610ARN1	131	DCU234GR01R350	89	DCU234S316GR	265
C610ARN5	131	DCU234GR04MB	89	DCU234S316GR01	265
C610ARNB	131	DCU234GR04R350	89	DCU234S316GR04	265
C610RN1	132	DCU234GRMB	89	DCU234S316RD	265
C610RN5	132	DCU234GRR350	89	DCU234S316RD01	265
C610RNB	132	DCU234MB305	90	DCU234S316TN	265
C611ARN1	131	DCU234MB305BR01	90	DCU234S316TN01	265
C611ARN5	131	DCU234MB305BR05	90	DCU234S316TN02	265
C611ARNB	131	DCU234MB305GR	90	DCU234S316TN03	265
C611RN1	132	DCU234MB305GR01	90	DCU234SBR01	265
C611RN5	132	DCU234MB305GR04	90	DCU234SBR05	265
C611RNB	132	DCU234MB305RD	90	DCU234SGR	265
C810ARN1	131	DCU234MB305RD01	90	DCU234SGR01	265
C810ARN5	131	DCU234MB305TN	90	DCU234SGR04	265
C810ARNB	131	DCU234MB305TN01	90	DCU234SRD	265
C810RN1	132	DCU234MB305TN02	90	DCU234SRD01	265
C810RN5	132	DCU234MB305TN03	90	DCU234STN	265
C810RNB	132	DCU234MB316	90	DCU234STN01	265
C811ARNB	131	DCU234MB316BR01	90	DCU234STN02	265
C811RN1	132	DCU234MB316BR05	90	DCU234STN03	265
C811RN5	132	DCU234MB316GR	90	DCU234TN01MB	89
C811RNB	132	DCU234MB316GR01	90	DCU234TN01R350	89
C1010ARN1	131	DCU234MB316GR04	90	DCU234TN02MB	89
C1010ARN5	131	DCU234MB316RD	90	DCU234TN02R350	89
C1010ARNB	131	DCU234MB316RD01	90	DCU234TN03MB	89
C1010RN1	132	DCU234MB316TN	90	DCU234TN03R350	89
C1010RN5	132	DCU234MB316TN01	90	DCU234TNMB	89
C1010RNB	132	DCU234MB316TN02	90	DCU234TNR350	89
C7511ARN1	131	DCU234MB316TN03	90	DHPDSS212MB	82
C7511ARN5	131	DCU234P305	90	DHPDSS212R100	82
C7511ARNB	131	DCU234P305BR01	90	DHPDSS212R350	82
C7511RN1	132	DCU234P305BR05	90	DHPDSS212R1000	82
C7511RN5	132	DCU234P305GR	90	DSVG3S	254, 256
C7511RNB	132	DCU234P305GR01	90	DSVG212S	254, 256
CB3BLG114S	254, 260	DCU234P305GR04	90	DSVR2MB	78
CB3BLG158S	254, 260	DCU234P305RD	90	DSVR2R1LB	78
CB3BLGHL114S	254, 260	DCU234P305RD01	90	DSVR2R5LB	78
CB3BLGHL158S	254, 260	DCU234P305TN	90	DSVR2R350	78
CBHL114R200	145	DCU234P305TN01	90	DSVR2S	254, 256
CBHL114R800	145	DCU234P305TN02	90	DSVR3MB	78
CBHL158R150	145	DCU234P305TN03	90	DSVR3R1LB	78
CBHL158R600	145	DCU234P316	90	DSVR3R5LB	78
CBHL214R100	145	DCU234P316BR01	90	DSVR3R350	78
CBSDQ158S	254, 281	DCU234P316BR05	90	DSVR3S	254, 256
CBSDQ214S	254, 281	DCU234P316GR	90	DSVR4MB	78
		DCU234P316GR01	90	DSVR4R1LB	78
		DCU234P316GR04	90	DSVR4R5LB	78
		DCU234P316RD	90	DSVR4R350	78
		DCU234P316RD01	90	DSVR114MB	78
		DCU234P316TN	90	DSVR114R1LB	78
		DCU234P316TN01	90	DSVR114R5LB	78
		DCU234P316TN02	90	DSVR114R350	78
		DCU234P316TN03	90	DSVR114S	254, 256
		DCU234RD01MB	89	DSVR158MB	78
		DCU234RD01R350	89	DSVR158R1LB	78
		DCU234RDMB	89	DSVR158R5LB	78

D

DCF620D2G2	245
DCSD238SBR01	255, 266
DCSD238SGR01	255, 266
DCSD238SGR04	255, 266
DCSD238SRD01	255, 266
DCSD238STN01	255, 266
DCSD238STN02	255, 266
DCU234	254

Alphabetical Index

DSVR158R350 78
 DSVR158S..... 254, 256
 DSVR212MB 78
 DSVR212R1LB 78
 DSVR212R5LB 78
 DSVR212R350 78
 DSVR212S..... 254, 256
 DSVR312MB 78
 DSVR312R1LB 78
 DSVR312R5LB 78
 DSVR312R350 78
 DSVT2MB 78
 DSVT2R1LB..... 78
 DSVT2R5LB..... 78
 DSVT2R350 78
 DSVT2S 254, 256
 DSVT3MB 78
 DSVT3R1LB..... 78
 DSVT3R5LB..... 78
 DSVT3R350..... 78
 DSVT3S 254, 256
 DSVT4MB 78
 DSVT4R1LB..... 78
 DSVT4R5LB..... 78
 DSVT4R350 78
 DSVT114MB..... 78
 DSVT114R1LB 78
 DSVT114R5LB 78
 DSVT114R350..... 78
 DSVT114S 256
 DSVT144S 254
 DSVT158MB 78
 DSVT158R1LB 78
 DSVT158R5LB 78
 DSVT158R350..... 78
 DSVT158S 254, 256
 DSVT212MB..... 78
 DSVT212R1LB 78
 DSVT212R5LB 78
 DSVT212R350..... 78
 DSVT212S 254, 256
 DSVT312MB 78
 DSVT312R1LB 78
 DSVT312R5LB 78
 DSVT312R350..... 78
 DTH212S305BR01 258
 DTH212S305BR05 258
 DTH212S305GR 258
 DTH212S305GR01 258
 DTH212S305GR03 258
 DTH212S305GR04 258
 DTH212S305PTN03 258
 DTH212S305RD01 258
 DTH212S305TN 258
 DTH212S305TN01 258
 DTH212S305TN02 258
 DTH212S305TN04 258
 DTHQ2S 254, 259
 DTHQ3S 254, 259
 DTHQ212S 254, 259
 DW267QD 244

DW276QD 244
 DWA1G2..... 247
 DWA2G2..... 247
 DWA3G2..... 247
 DWA4G2..... 247
 DWA6G2..... 247
 DWA7G2..... 247
 DWAG2..... 247
 DWASWG2 247
 DWC1PS 255, 270
 DWC2PS 255, 270
 DWC114PS 255, 270
 DWC158PS 255, 270
 DWC212PS 255, 270
 DWF1PS 255, 287
 DWF114PS 255, 282, 287
 DWF158PS 255, 282, 287
 DWFSD114PS 255, 282, 287
 DWFSD158PS 255, 282, 287
 DWFSD178PS 255, 282, 287
 DWFSD238PS 255, 282, 287
 DWFSDQ114PS 255, 282, 287
 DWHL178PS 255, 271

E

E1B1414..... 287, 374
 E1B1414B 99
 E1B1414R100 99
 EBE002 155
 EBE004 155
 EBE005LC 155
 EBE006JR 155
 EBE007MINI 155
 EBEOA 155

F

F06T125BDB 105
 F06T125BDC 105
 F06T125BDM 105
 F06T125TDB 108
 F07T162TDB 108
 F07T162TDC 108
 F07T162TDM 108
 F07T225TDB 108
 F07T225TDC 108
 F07T225TDM 108
 F07T300TDB 108
 F07T300TDC 108
 F07T300TDM 108
 F08T056KDB 110
 F08T056KDC 110
 F08T056KDM 110
 F08T075KDB 110
 F08T075KDC 110
 F08T075KDM 110
 F08T125KDB 110
 F08T125KDC 110
 F08T125KDM 110

F08T162BDB 105
 F08T162BDC 105
 F08T162BDM 105
 F08T162KDB 110
 F08T162KDC 110
 F08T162KDM 110
 F08T162WDB 106
 F08T162WDC 106
 F08T162WDM 106
 F08T200BDB 105
 F08T200BDC 105
 F08T200BDM 105
 F08T200KDB 110
 F08T200KDC 110
 F08T200KDM 110
 F08T225WDB 106
 F08T225WDC 106
 F08T225WDM 106
 F10C144WDB 109
 F10C144WDC 109
 F10C144WDM 109
 F10T100PSB 104
 F10T100PSC 104
 F10T100PSM 104
 F10T100PTB 149
 F10T100PTC 149
 F10T100PTM 149
 F10T200PTC 149
 F10T200PTM 149
 F10T250BDB 105
 F10T250BDC 105
 F10T250BDM 105
 F10T300BDB 105
 F10T300BDC 105
 F10T350BDB 105
 F10T350BDC 105
 F12C200FDB 107
 F12C200FDC 107
 F12C200FDM 107
 F12C250FDB 107
 F12C250FDC 107
 F12C250FDM 107
 F14C325FDB 107
 F14C325FDC 107
 FEA1G2 247
 FEASCS63 245
 FHSD1S1018 255, 283
 FHSD114S0818 255, 283, 287
 FPHSD34B1016 102
 FPHSD34B1016-5K 102
 FPHSD34B1214 102
 FPHSD34B1214-5K 102
 FPHSD34S1016 255, 275, 287, 373
 FPHSD34S1214 255, 275, 287, 373

G

G2HANDLE 249

Alphabetical Index

H

H2.5A.....	347
HCKDSVR2S.....	256
HCKDSVR3S.....	256
HCKDSVR114S.....	256
HCKDSVR158S.....	256
HCKDSVR212S.....	256
HCKDSVT2S.....	256
HCKDSVT3S.....	256
HCKDSVT114S.....	256
HCKDSVT158S.....	256
HCKDSVT212S.....	256
HCKDTHQ3S.....	259
HCKDTHQ212S.....	259
HCKDWC114PS.....	270
HCKDWC158PS.....	270
HCKMTH114S.....	271
HCKWSNTG212S.....	267
HCKWSNTL2LS.....	268
HCKWSNTL3S.....	268
HCKWSNTL134S.....	268
HCKWSNTL212S.....	268
HCKWSNTLG2S.....	267
HCKWSNTLG3S.....	267
HG112WS.....	255, 261
HG112WT10.....	255, 261, 262
HIA1G2.....	247
HIAG2.....	247
HIW8VB2.....	224, 225, 240, 244
HJ112WT10.....	255, 261
HJ112WT10-0105.....	262
HJ112WT10-0402.....	262
HJ112WT10-0434.....	262
HJ112WT10-0701.....	262
HJ112WT10-0703.....	262
HJ112WT10-1005.....	262
HJ112WT10-1006.....	262
HJ112WT10-1103.....	262
HJ112WT10-1106.....	262
HJ112WT10-1107.....	262
HJ112WT10-X.....	262
HT18G2.....	247
HTAG2.....	247
HTASWG2.....	247

I

I6PSNB.....	125
I8PSNB.....	125
I16PSNB.....	125

L

L70Z.....	370
LS70Z.....	370

M

MA6807Z.....	245
MAA1G2.....	247
MAA2G2.....	247
MAA3G2.....	247
MAA6G2.....	247
MAA7G2.....	247
MAA6807G2.....	247
MAAG2.....	247
MAFS2500.....	244
MAFS2701.....	245
MAFS3500.....	245
MAFS6200.....	245
MIA1G2.....	247
MIAG2.....	247
MTH114R250.....	96
MTH114R1200.....	96
MTH114S.....	254, 271
MTHZ1S.....	254, 271
MTS12.....	347

N

N8.....	139, 337, 338
N8BRPT4000.....	158
N8D5HDG-R.....	139
N8DHDG-R.....	139
N8HDGPT500.....	158
N8HDGPT4000.....	158
N10.....	139, 337, 338
N10BRPT3000.....	158
N10D.....	338
N10D5HDG-R.....	139
N10DBRPT2500.....	158
N10DEGPT2500.....	158
N10DHDGPT500.....	158
N10DHDGPT2500.....	158
N10DHDG-R.....	139
N10EGPT3000.....	158
N10HDGPT500.....	158
N10HDGPT3000.....	158
N16.....	328, 338
N16HDGPT500.....	158
N16HDGPT2000.....	158
N54A.....	138
N54AHDG.....	138

P

PADJARMBGP300G2.....	249
PC1B1012-5K.....	150
PC1B1211-4K.....	150
PC1BS1012.....	255, 272, 287, 375
PC1BS1211.....	255, 272, 287, 375
PCAPS100.....	152
PCQ1B1012-5K.....	150
PCQ1B1211-4K.....	150
PCQ1BS1012.....	255, 263
PCQ1BS1211.....	255, 263

PCQ112B1012-4K.....	150
PCQ112BS1012.....	255, 263
PCSD1B1016-5K.....	104
PCSD1B1214-4K.....	104
PCSD1S1016.....	255, 280, 287, 375
PCSD1S1214.....	255, 280, 287, 375
PCSDQ1B1016-5K.....	104
PCSDQ1B1214-4K.....	104
PCSDQ1S1016.....	255, 280
PCSDQ1S1214.....	255, 280
PFEEDPAWL.....	249
PFEEDPAWL2.....	249
PFEEDPAWL3.....	249
PFEEDPAWL5.....	249
PFEEDPAWLTL.....	249
PHSD34S0818.....	255, 275, 287, 372
PHSS2S.....	254
PHSS212S.....	254, 273
PMANDREL6.....	248
PMANDREL10.....	231, 243, 248, 250
PMANDREL55.....	248
PMANDREL65.....	220, 227, 232,234, 236, 240, 241, 248, 250
PMANDREL65-RC.....	248
PMANDREL75.....	221, 222, 223, 224,225, 228, 229, 232, 233, 234,236, 237, 238, 239, 241, 242, 250
PMANDREL75-RC.....	248
PMANDREL158.....	248
PNOSECLIP.....	249
PNOSEGUARD-5.....	239, 241, 249
PPROFILEGUIDE5V.....	249
PPROFILEGUIDE11.....	249
PPROFILEGUIDE22.....	249
PPROFILEGUIDE23.....	249
PPROFILEGUIDE32.....	249
PPROFILEGUIDE33.....	249
PPROFILEGUIDE34.....	249
PPSD3B1016-2K.....	101
PPSD3B1214-2K.....	101
PPSD3S1016.....	255, 276, 371
PPSD3S1214.....	255, 276
PPSD134B1016-4K.....	101
PPSD134B1214-4K.....	101
PPSD134S1016.....	255, 276, 371
PPSD134S1214.....	255, 276
PPSD11516B-4K.....	101
PPSD11516S.....	287
PPSD11516S0818.....	255, 276, 371
PPSDQ3B1016-2K.....	101
PPSDQ3B1214-2K.....	101
PPSDQ3S1016.....	276, 371
PPSDQ3S1214.....	276
PPSDQ134B1016-4K.....	101
PPSDQ134B1214-4K.....	101
PPSDQ134S1016.....	276, 371
PPSDQ134S1214.....	276
PPSDQ11516B-4K.....	101
PPSDQ11516S0818.....	276, 371
PRO200G2D25K.....	220, 244
PRO200G2M25K.....	220, 244

Alphabetical Index

PRO200SD25K.....	221
PRO200SG2D25K.....	244
PRO250G2D25K.....	222, 244
PRO250G2M25K.....	222, 244
PRO250G2M35K.....	222, 245
PRO300SD25K.....	223, 244
PRO300SM25K.....	223, 244
PRO300SM35K.....	223, 245
PRO300SRFG2M25K.....	229, 244
PRO300SRFG2M35K.....	229, 245
PROCCS+D25K.....	233, 244
PROCCS+M25K.....	233, 244
PROCGBM25K.....	234, 244
PROHSD60H17K.....	224, 244
PROHSD60M25K.....	224, 244
PROHSD60MVK.....	224, 245
PROHSD75H17K.....	225, 244
PROHSD75MVK.....	225, 245
PROHX14G2M25K.....	226
PROHX516M25K.....	244
PROHX516MATK.....	245
PROLDHG2M25K.....	227, 244
PROPP150G2DATK.....	231, 244
PROPP150G2M25K.....	231, 244
PRORFG2M25K.....	228, 244
PRORFG2M35K.....	228, 245
PROSDD25K.....	232, 244
PROSDDM25K.....	232, 244
PROSDDM35K.....	232, 245
PROSDX150G2DATK.....	230, 244

Q

QDBGP75KE.....	235
QDBGP300G2K.....	219, 235, 250
QDBSD200G2.....	218, 235
QDBSD200G2DATK.....	218, 244
QDBSD200G2K.....	218
QDDECKCLIP-RC.....	249
QDEXTG2.....	249
QDEXTG2-16.....	218, 230, 249
QDEXTG2-22.....	249
QDHSD60.....	224, 238, 250
QDHSD75.....	225, 239, 250
QDLEAFSPRING.....	248
QDLEAFSPRING2.....	248
QDPRO200G2.....	220, 232, 236, 250
QDPRO200S.....	221, 236
QDPRO200SG2.....	233, 234
QDPRO250DWG2.....	237
QDPRO250G2.....	222, 237, 250
QDPRO300SG2.....	223, 232, 233, 238, 250
QDPRO300SRFG2.....	229, 242, 250
QDPROHX14G2.....	226, 239
QDPROHX516G2.....	240, 250
QDPROLDHG2.....	227, 234, 240, 250
QDPROPHG2.....	241, 250
QDPROPP150G2.....	231, 243, 250
QDPRORFG2.....	228, 241, 250
QDPROSD150G2.....	250

QDPROSDX150G2.....	230, 242
QUIVER.....	249

S

S2ACN1.....	118
S2ACN5.....	118
S2ACNB.....	118
S2CN1.....	119
S2CN5.....	119
S2CNB.....	119
S2FN1.....	121
S2FNB.....	121
S2HACN1.....	118
S2HACN5.....	118
S2HACNB.....	118
S3ABN1.....	115
S3ABN5.....	115
S3ABNB.....	115
S3ACDRWVR1.....	117
S3ACDRWVR5.....	117
S3ACN1.....	118
S3ACN5.....	118
S3ACNB.....	118
S3CN1.....	119
S3CN5.....	119
S3CNB.....	119
S3FN1.....	121
S3FN5.....	121
S3FNB.....	121
S3SN7B.....	128
S3SN71.....	128
S3SN75.....	128
S3SND1.....	117
S3SND5.....	117
S3SNDB.....	117
S4ABN1.....	115
S4ABN5.....	115
S4ABNB.....	115
S4ACN1.....	118
S4ACN5.....	118
S4ACNB.....	118
S4CN1.....	119
S4CN5.....	119
S4CNB.....	119
S4FN1.....	121
S4FN5.....	121
S4FNB.....	121
S4HCN1.....	119
S4HCN5.....	119
S4HCNB.....	119
S4PTD1.....	124
S4PTD5.....	124
S4PTDB.....	124
S4SN71.....	128
S4SN75.....	128
S4SN7B.....	128
S4SND1.....	117
S4SND5.....	117
S4SNDB.....	117

S4SNDR1.....	127
S4SNDR5.....	127
S4SNDT1.....	127
S4SNDT5.....	127
S4SNDWB.....	127
S5ABN1.....	115
S5ABN5.....	115
S5ABNB.....	115
S5ACDRWVRB.....	117
S5ACN1.....	118
S5ACN5.....	118
S5ACNB.....	118
S5CNB.....	119
S5FN1.....	121
S5FN5.....	121
S5FNB.....	121
S5SN71.....	128
S5SN75.....	128
S5SN7B.....	128
S5SND1.....	117
S5SND5.....	117
S5SNDB.....	117
S6ABN1.....	115
S6ABN5.....	115
S6ABNB.....	115
S6ACN1.....	118
S6ACN5.....	118
S6ACNB.....	118
S06C125DBP.....	85
S06C162DBP.....	85
S6CN1.....	119
S6CN5.....	119
S6CNB.....	119
S6FN1.....	121
S6FN5.....	121
S6FNB.....	121
S6PTD1.....	124
S6PTD5.....	124
S6PTDB.....	124
S6SN71.....	128
S6SN75.....	128
S6SN7B.....	128
S6SND1.....	117
S6SND5.....	117
S6SNDB.....	117
S6SNDB1.....	127
S6SNDB5.....	127
S6SNDBB.....	127
S6SNDG1.....	127
S6SNDG5.....	127
S6SNDGB.....	127
S6SNDR1.....	127
S6SNDR5.....	127
S6SNDRB.....	127
S6SNDS1.....	127
S6SNDS5.....	127
S6SNDSB.....	127
S6SNDT1.....	127
S6SNDT5.....	127
S6SNDTB.....	127
S6SNDW1.....	127

Alphabetical Index

S6SNDW1	127	S8SN7B.....	128	S10CNB.....	119
S6SNDW5	127	S8SND1.....	117	S10CRD1.....	116
S6SNDWB.....	127	S8SND5.....	117	S10CRD5.....	116
S7ABN1.....	115	S8SNDB.....	117	S10CRDB.....	116
S7ABN5.....	115	S8SNDB1.....	127	S10FN1.....	121
S7ABNB.....	115	S8SNDB5.....	127	S10FN5.....	121
S7ACN1.....	118	S8SNDBB.....	127	S10FNB.....	121
S7ACN5.....	118	S8SNDG1.....	127	S10HPTD1.....	124
S7ACNB.....	118	S8SNDG5.....	127	S10HPTD5.....	124
S07C162FBP.....	86	S8SNDGB.....	127	S10HPTDB.....	124
S07C162PAK.....	86	S8SNDR1.....	127	S10N062SWC.....	153
S07C162XOM.....	150	S8SNDR5.....	127	S10N062SWM.....	153
S07C225FBP.....	86	S8SNDRB.....	127	S10PTD1.....	124
S07C225PAK.....	86	S8SNDS1.....	127	S10PTD5.....	124
S07C300FBP.....	86	S8SNDS5.....	127	S10PTDB.....	124
S07C300PAK.....	86	S8SNDSB.....	127	S10S350CNB.....	171
S7SN71.....	128	S8SNDT1.....	127	S10S350CNJ.....	171
S7SN75.....	128	S8SNDT5.....	127	S10SND1.....	117
S7SN7B.....	128	S8SNDTB.....	127	S10SND5.....	117
S7SND1.....	117	S8SNDW1.....	127	S10SNDB.....	117
S7SND5.....	117	S8SNDW5.....	127	S10SNDB1.....	127
S7SNDB.....	117	S8SNDWB.....	127	S10SNDB5.....	127
S8ABN1.....	115	S9A225CNJ.....	170	S10SNDBB.....	127
S8ABN5.....	115	S9N300CNJ.....	172	S10SNDG1.....	127
S8ABNB.....	115	S10A150XOM.....	122	S10SNDG5.....	127
S8ACN1.....	118	S10A175XOM.....	122	S10SNDGB.....	127
S8ACN5.....	118	S10A250CNB.....	170	S10SNDR1.....	127
S8ACNB.....	118	S10A300CNB.....	170	S10SNDR5.....	127
S8APB1.....	123	S10A300CNJ.....	170	S10SNDRB.....	127
S8APB5.....	123	S10A300PNJ.....	167	S10SNDT1.....	127
S08C075KQC.....	151	S10A325CNB.....	170	S10SNDT5.....	127
S08C075KQM.....	151	S10A325CNJ.....	170	S10SNDTB.....	127
S08C100TSC.....	151	S10A325KDJ.....	169	S10SNDW1.....	127
S08C100TSM.....	151	S10A325KJB.....	169	S10SNDW5.....	127
S08C125KQC.....	151	S10A325KJG.....	169	S10SNDWB.....	127
S08C125KQM.....	151	S10A325KJR.....	169	S10T100PDM.....	149
S08C125TSC.....	151	S10A325KJS.....	169	S10T100PDQ25.....	149
S08C125TSM.....	151	S10A325KJT.....	169	S10T125P25.....	149
S08C150TSC.....	151	S10A325PNJ.....	167	S10T125PDM.....	149
S08C150TSM.....	151	S10A325T31.....	175	S10T150P25.....	149
S08C200DBP.....	85	S10A325W28.....	174	S10T150PDM.....	149
S08C250TSC.....	151	S10A350CNB.....	170	S10T200P25.....	149
S08C250TSM.....	151	S10A350CNJ.....	170	S10T200PDM.....	149
S8CN1.....	119	S10A350T31.....	175	S11A100RNB.....	165
S8CN5.....	119	S10ABN1.....	115	S11A125RNB.....	165
S8CNB.....	119	S10ABN5.....	115	S11A125RNB.....	165
S8CRD1.....	116	S10ABNB.....	115	S11A125RNB.....	165
S8CRD5.....	116	S10ACN1.....	118	S11A125RNBP.....	165
S8CRDB.....	116	S10ACN5.....	118	S11A125RNJ.....	165
S8FN1.....	121	S10ACNB.....	118	S11A150RNB.....	165
S8FN5.....	121	S10APB5.....	123	S11A150RNBP.....	165
S8FNB.....	121	S10APBB.....	123	S11A150RNJ.....	165
S8HPTD1.....	124	S10C250DBP.....	85	S11A175RNB.....	165
S8HPTD5.....	124	S10C250DTP.....	83	S11A175RNBP.....	165
S8HPTDB.....	124	S10C250PAK.....	85	S11A175RNJ.....	165
S8N350CNJ.....	172	S10C300DBP.....	85	S11A200CNB.....	170
S8PTD1.....	124	S10C300DTP.....	83	S11A200CNJ.....	170
S8PTD5.....	124	S10C300PAK.....	85	S11A237KDJ.....	169
S8PTDB.....	124	S10C350DBP.....	85	S11A237KJB.....	169
S8SN71.....	128	S10CN1.....	119	S11A237KJG.....	169
S8SN75.....	128	S10CN5.....	119	S11A237KJR.....	169
				S11A237KJS.....	169
				S11A237KJT.....	169

Alphabetical Index

S11A250CNB	170	S12FNB	121	S15N200BFS	182
S11A250CNJ	170	S12N062SWC	153	S15N200FNB	176
S11A300B31	173	S12N062SWM	153	S15N200FNJ	176
S11A300CNB	170	S12N237CNB	172	S15N200SFB	180
S11A300CNJ	170	S12N237CNJ	172	S15N200SFN	180
S11A300P31	173	S12PTD1	124	S15N250FNB	176
S11A300PJB	168	S12PTD5	124	S15N250FNJ	176
S11A300PJG	168	S12PTDB	124	S15N250SFB	180
S11A300PJR	168	S12S200CNB	171	S15N250SFN	180
S11A300PJS	168	S12S200CNJ	171	S16ABN1	115
S11A300PJT	168	S12S250CNB	171	S16ABN5	115
S11A300PNJ	167	S12S250CNJ	171	S16ABNB	115
S11A300T31	175	S12SND1	117	S16ACN1	118
S11A300W28	174	S12SND5	117	S16ACN5	118
S11A325CNB	170	S12SNDB	117	S16ACNB	118
S11A325CNJ	170	S13A125SNBP	163	S16APBB	123
S11A325PJB	168	S13A125SNC	163	S16B150LCT	181
S11A325PJG	168	S13A150IPC	161	S16B200LCT	181
S11A325PJR	168	S13A150SNBP	163	S16B200TNL	181
S11A325PJT	168	S13A150SNC	163	S16CN1	119
S11A325PNJ	167	S13A175IPC	161	S16CN5	119
S11N075RNB	166	S13A175SNBP	163	S16CNB	119
S11N087RNB	166	S13A175SNC	163	S16FN1	121
S11N100RNB	166	S13A200CCB	164	S16FN5	121
S11N100RNJ	166	S13A200CCG	164	S16FNB	121
S11N125RNB	166	S13A200CCR	164	S16HPTD1	124
S11N125RNJ	166	S13A200CCT	164	S16HPTD5	124
S11N150RNB	166	S13A200CWH	164	S16HPTDB	124
S11N150RNJ	166	S13A200IPC	161	S16N075P51	182
S11N175RNB	166	S13A200SNBP	163	S16N100N13	185
S11N175RNJ	166	S13A200SNC	163	S16N125GS	183
S11S300CNB	171	S13A200WWCBP	164	S16N125GS-R1000	183
S11S300CNJ	171	S13A225CCB	164	S16N125N15	185
S11S325CNB	171	S13A225CCG	164	S16N125N15-R1000	185
S11S325CNJ	171	S13A225CCR	164	S16N125P55	182
S12A150PNB	167	S13A225CCS	164	S16N150FNB	177
S12A175PNB	167	S13A225CCT	164	S16N150FNJ	177
S12A200CNB	170	S13A225CWH	164	S16N150GS	183
S12A200CNJ	170	S13A225IPBP	161	S16N150GS-R1000	183
S12A200PNB	167	S13A225IPC	161	S16N150N17	185
S12A200T31	175	S13A225SNBP	163	S16N150N17-R1000	185
S12A225DNB	160	S13A225SNC	163	S16N150PFB	176
S12A225DNBP	160	S13A250CCB	164	S16N150PFN	176
S12A237B31	173	S13A250CCBBP	164	S16N175GS	183
S12A237CNB	170	S13A250CCG	164	S16N175GS-R1000	183
S12A237CNJ	170	S13A250CCR	164	S16N175N19	185
S12A237P31	173	S13A250CCS	164	S16N200FNB	177
S12A237PNB	167	S13A250CCSBP	164	S16N200FNJ	177
S12A237T31	175	S13A250CCT	164	S16N200GS	183
S12A237W28	174	S13A250CCTBP	164	S16N200N21	185
S12A250PNB	167	S13A250CWH	164	S16N200N21-R1000	185
S12ABN1	115	S13A250IPBP	161	S16N200PFB	176
S12ABN5	115	S13A250IPC	161	S16N200PFN	176
S12ABNB	115	S13A250IPWBP	162	S16N250FNB	177
S12ACN1	118	S13A250SNBP	163	S16N250FNJ	177
S12ACN5	118	S13A250SNC	163	S16N250PFB	176
S12ACNB	118	S13A250WWCBP	164	S16N250PFN	176
S12CN1	119	S15N150FNB	176	S16PTD1	124
S12CNB	119	S15N150FNJ	176	S16PTD5	124
S12FN1	121	S15N150SFB	180	S16PTDB	124
S12FN5	121	S15N150SFN	180	S16SND1	117

Alphabetical Index

S16SND5.....	117	S23N100MPN	179	S1010ARN1.....	130
S16SNDB	117	S23N119MPB.....	179	S1010ARN5.....	130
S16SNDB1	127	S23N119MPN	179	S1010ARNB	130
S16SNDB5.....	127	S23N150MPB.....	179	S06075DBB.....	85
S16SNDBB.....	127	S23N150MPN	179	S06100DB1.....	85
S16SNDG1.....	127	S23N175MPB.....	179	S06100DB5.....	85
S16SNDG5.....	127	S23N175MPN	179	S06100DBB.....	85
S16SNDGB.....	127	S30ACN1.....	118	S06125DB1.....	85
S16SNDR1	127	S30ACN5.....	118	S06125DB5.....	85
S16SNDR5.....	127	S30ACNB	118	S06125DBB.....	85
S16SNDRB.....	127	S30APB5	123	S06125DT1	83
S16SNDS1	127	S30APBB.....	123	S06125DT5.....	83
S16SNDS5.....	127	S40ACN1.....	118	S06125DTB.....	83
S16SNDSB.....	127	S40ACN5.....	118	S06162DB1.....	85
S16SNDT1.....	127	S40ACNB	118	S06162DB5.....	85
S16SNDT5.....	127	S40APBB.....	123	S06162DBB.....	85
S16SNDTB.....	127	S40ATN5	133	S07100WP1	81
S18N062L10	184	S40ATNB.....	133	S07100WP5.....	81
S18N075FNB	178	S40CN1	119	S07100WPB.....	81
S18N075FNJ	178	S40CN5.....	119	S07125WP1	81
S18N100FNB	178	S40CNB.....	119	S07125WP5.....	81
S18N100FNJ	178	S40TNB	134	S07125WPB.....	81
S18N100L13	184	S60ACN1.....	118	S07125WPP.....	81
S18N100L13-R1000	184	S60ACN5.....	118	S07162FB1.....	86
S18N112L14	184	S60ACNB	118	S07162FB5.....	86
S18N125FNB	178	S60APBB.....	123	S07162FBB.....	86
S18N125FNJ	178	S60CN1	119	S07162FT1	88
S18N125L15	184	S60CN5.....	119	S07162FT1WH01	87
S18N125L15-R1000	184	S60CNB.....	119	S07162FT5.....	88
S18N150FNB	178	S70ACN1.....	118	S07162FT5WH01	87
S18N150FNJ	178	S70ACNB	118	S07162FTB.....	88
S18N150L17	184	S210ARN1.....	130	S07162FWP.....	81
S18N150L17-R1000	184	S210ARN5.....	130	S07162WP1	81
S18N175FNJ	178	S210ARNB.....	130	S07162WP5.....	81
S18N200FNB	178	S310ARN1.....	130	S07162WPB.....	81
S18N200FNJ	178	S310ARN5.....	130	S07162WPP.....	81
S20ABN1	115	S310ARNB.....	130	S07200WP1	81
S20ACN1.....	118	S311ARN1.....	130	S07200WP5.....	81
S20ACN5.....	118	S311ARN5.....	130	S07200WPB.....	81
S20ACNB	118	S311ARNB.....	130	S07200WPP.....	81
S20APBB.....	123	S410ARN1.....	130	S07225FB1.....	86
S20CN1	119	S410ARN5.....	130	S07225FB5.....	86
S20CN5.....	119	S410ARNB.....	130	S07225FBB.....	86
S20CNB.....	119	S411ARN1.....	130	S07225FT1	88
S20FN1.....	121	S411ARN5.....	130	S07225FT1WH01	87
S20FN5.....	121	S411ARNB.....	130	S07225FT5.....	88
S20FNB	121	S510ARN1.....	130	S07225FT5WH01	87
S20HPTD1.....	124	S510ARN5.....	130	S07225FTB.....	88
S20HPTD5.....	124	S510ARNB.....	130	S07225FTBBR01.....	87
S20HPTDB	124	S511ARN1.....	130	S07225FTBBR05.....	87
S20PTD1	124	S511ARN5.....	130	S07225FTBGR	87
S20PTD5.....	124	S511ARNB.....	130	S07225FTBGR01	87
S20PTDB.....	124	S610ARN1.....	130	S07225FTBGR03	87
S20SND1.....	117	S610ARN5.....	130	S07225FTBGR04	87
S20SND5.....	117	S610ARNB.....	130	S07225FTBRD01.....	87
S20SNDB	117	S611ARN1.....	130	S07225FTBTN.....	87
S23N050MPB.....	179	S611ARN5.....	130	S07225FTBTN01	87
S23N050MPN	179	S611ARNB.....	130	S07225FTBTN02	87
S23N075MPB.....	179	S810ARN1.....	130	S07225FTBTN04	87
S23N075MPN	179	S810ARN5.....	130	S07225FTBWH01	87
S23N100MPB.....	179	S810ARNB.....	130	S07225FTP.....	88

Alphabetical Index

S07225FTPBR01.....	87	S08200DTB.....	83	S10175RNWB.....	129
S07225FTPBR05.....	87	S08200WP1.....	80	S10200DB1.....	85
S07225FTPGR.....	87	S08200WP5.....	80	S10200DB5.....	85
S07225FTPGR01.....	87	S08200WPB.....	80	S10200DBB.....	85
S07225FTPGR03.....	87	S08200WPP.....	80	S10200DXB.....	91
S07225FTPGR04.....	87	S08225DB1.....	85	S10200DXP.....	91
S07225FTPGRD01.....	87	S08225DB5.....	85	S10200FS1.....	141
S07225FTPTN.....	87	S08225DBB.....	85	S10200FS5.....	141
S07225FTPTN01.....	87	S08250DB1.....	85	S10200FSB.....	141
S07225FTPTN02.....	87	S08250DB5.....	85	S10200RNW5.....	129
S07225FTPTN04.....	87	S08250DBB.....	85	S10200RNWB.....	129
S07225FWP.....	81	S08250FWP.....	81	S10200WP1.....	80
S07225WP1.....	81	S08250TSBC.....	151	S10200WP5.....	80
S07225WP5.....	81	S08250WCI.....	81	S10200WPB.....	80
S07225WPB.....	81	S08250WJI.....	81	S10225DB1.....	85
S07225WPP.....	81	S08250WPB.....	81	S10225DB5.....	85
S07250WP1.....	81	S08250WPF1.....	80	S10225DBB.....	85
S07250WP5.....	81	S08250WPF5.....	80	S10250DB1.....	85
S07250WPB.....	81	S08250WPFB.....	80	S10250DB5.....	85
S07250WPP.....	81	S08250WPP.....	81	S10250DBB.....	85
S07300FB1.....	86	S08300DB1.....	85	S10250DT1.....	83
S07300FB5.....	86	S08300DB5.....	85	S10250DT5.....	83
S07300FBB.....	86	S08300DBB.....	85	S10250DTB.....	83
S07300FT1.....	88	S08300FWP.....	81	S10250DXB.....	91
S07300FT5.....	88	S08300WPB.....	81	S10250DXC.....	91
S07300FTB.....	88	S08300WPF1.....	80	S10250DXP.....	91
S07300FWP.....	81	S08300WPF5.....	80	S10250RNW5.....	129
S07300WP1.....	81	S08300WPFB.....	80	S10250RNWB.....	129
S07300WP5.....	81	S08300WPP.....	81	S10250WCI.....	81
S07300WPB.....	81	S09350FWP.....	81	S10250WJI.....	81
S7510ARN1.....	130	S09350WP1.....	81	S10250WP1.....	80
S7510ARN5.....	130	S09350WP5.....	81	S10250WP5.....	80
S7510ARNB.....	130	S09350WPB.....	81	S10250WPB.....	80
S08100TSBC.....	151	S09400WP1.....	81	S10250WPP.....	80
S08112DB1.....	85	S09400WP5.....	81	S10262PHB.....	152
S08112DB5.....	85	S09400WPB.....	81	S10300DB1.....	85
S08112DBB.....	85	S10100DB1.....	85	S10300DB5.....	85
S08125DB1.....	85	S10100DB5.....	85	S10300DBB.....	85
S08125DB5.....	85	S10100DBB.....	85	S10300DT1.....	83
S08125DBB.....	85	S10100WP1.....	80	S10300DT5.....	83
S08125DBH.....	85	S10100WP5.....	80	S10300DTB.....	83
S08125TSBC.....	151	S10100WPB.....	80	S10300DXB.....	91
S08125WP1.....	80	S10125DB1.....	85	S10300DXC.....	91
S08125WP5.....	80	S10125DB5.....	85	S10300DXP.....	91
S08125WPB.....	80	S10125DBB.....	85	S10300RNW5.....	129
S08150TSBC.....	151	S10125PHB.....	152	S10300RNWB.....	129
S08162DB1.....	85	S10150DB1.....	85	S10300WCI.....	81
S08162DB5.....	85	S10150DB5.....	85	S10300WJI.....	81
S08162DBB.....	85	S10150DBB.....	85	S10300WP1.....	80
S08162DT1.....	83	S10150DXB.....	91	S10300WP5.....	80
S08162DT5.....	83	S10150DXC.....	91	S10300WPB.....	80
S08162DTB.....	83	S10150DXP.....	91	S10300WPP.....	80
S08162WP1.....	80	S10150RNW5.....	129	S10350DB1.....	85
S08162WP5.....	80	S10150RNWB.....	129	S10350DB5.....	85
S08162WPB.....	80	S10150WP1.....	80	S10350DBB.....	85
S08162WPP.....	80	S10150WP5.....	80	S10350DT1.....	83
S08200DB1.....	85	S10150WPB.....	80	S10350DT5.....	83
S08200DB5.....	85	S10175DB1.....	85	S10350DTB.....	83
S08200DBB.....	85	S10175DB5.....	85	S10350WP1.....	80
S08200DT1.....	83	S10175DBB.....	85	S10350WP5.....	80
S08200DT5.....	83	S10175RNW5.....	129	S10350WPB.....	80

Alphabetical Index

S10375DB1	85	S14100EP1.....	140	SDS25312-R25L	75
S10375DB5	85	S14100EP5.....	140	SDS25312SS.....	75, 329, 332
S10375DBB.....	85	S14400DB1	85	SDS25312SS-R25.....	75
S12125HDUC.....	147	S14400DB5	85	SDS25312SS-R25L.....	75
S12125HDUM	147	S14400DBB.....	85	SDS25412	75, 329, 330, 331, 333
S12125HOC	148	S14400WP5	80	SDS25412MB.....	75
S12125HOM.....	148	S14400WPB.....	80	SDS25412-R10	75
S12150HDUC.....	147	S14400WPP.....	80	SDS25500	75, 329, 330, 332, 333
S12150HDUM	147	S14500DB1	85	SDS25500MB.....	75
S12150HOC	148	S14500DB5	85	SDS25500-R10	75
S12150HOM.....	148	S14500DBB.....	85	SDS25500-R25L	75
S12200HDUC.....	147	S16050EP1.....	140	SDS25600	75, 329, 330, 333
S12200HDUM	147	S16050EP5.....	140	SDS25600MB.....	75
S12200HOC	148	S16062EP1.....	140	SDS25600-R10	75
S12200HOM.....	148	S16062EP5.....	140	SDS25800	75, 329, 330
S12250DBB.....	85	S16075EP1.....	140	SDS25800-R10	75
S12250HDUC.....	147	S16075EP5.....	140	SDS25800-R50	75
S12250HDUM	147	S18050EP1.....	140	SDW22300	94, 356, 360, 361, 362, 363
S12250WP1	80	SD8x1.25	339	SDW22300MB.....	94
S12250WP5	80	SD8x1.25-R	96	SDW22338	93, 357, 360
S12250WPB.....	80	SD9112.....	334	SDW22338MB.....	93
S12300DBB.....	85	SD9112MB.....	76	SDW22338-R50	93
S12300HDUC.....	147	SD9112R100.....	76	SDW22438	94, 356, 360, 361, 362, 363
S12300HDUM	147	SD9112R500.....	76	SDW22438MB.....	94
S12300WP1	80	SD9212.....	334	SDW22438-R50	94
S12300WP5	80	SD9212MB.....	76	SDW22458	94, 356, 360
S12300WPB.....	80	SD9212R100-R	76	SDW22458MB.....	94
S12350DBB.....	85	SD9212R500.....	76	SDW22458-R50	94
S12350WP1	80	SD10112.....	334	SDW22500	93, 357, 360
S12350WP5	80	SD10112DBB	334	SDW22500MB.....	93
S12350WPB.....	80	SD10112DBB-R50	307	SDW22500-R50	93
S12400DBB.....	85	SD10112DBBR50.....	74	SDW22600	94, 356, 360, 361, 362, 363
S12400WP1	80	SD10112MB.....	76	SDW22600MB.....	94
S12400WP5	80	SD10112R100.....	76	SDW22600-R50	94
S12400WPB.....	80	SD10112R500.....	76	SDW22634	93, 357, 360
S12400WPP.....	80	SD10212.....	334	SDW22634MB.....	93
S12450DBB.....	85	SD10212MB.....	76	SDW22634-R50	93
S12450WP1	80	SD10212R100-R.....	76	SDW22638	94, 356, 360
S12450WP5	80	SD10212R500.....	76	SDW22638MB.....	94
S12450WPB.....	80	SDS25112	75, 329	SDW22638-R50	94
S12500DBB.....	85	SDS25112MB.....	75	SDWC15450.....	92, 340, 344, 345, 348
S12500WP1	80	SDS25112-R25	75	SDWC15450B-KT	92
S12500WP5	80	SDS25112SS.....	75, 329	SDWC15450-KT.....	92
S12500WPB.....	80	SDS25112SS-R25.....	75	SDWC15600.....	92, 340, 341, 342, 344, 345, 348, 349, 351
S12600DB5.....	85	SDS25200	75, 329, 330	SDWC15600B-KT	92
S12600DBB.....	85	SDS25200MB.....	75	SDWC15600-KT.....	92
S13075HR1	141	SDS25200-R25	75	SDWC154500.....	344
S13075HR5.....	141	SDS25200SS-R25.....	75	SDWF2716-TUW	95, 353, 354
S13075HRB.....	141	SDS25212	75, 329, 330	SDWF2720-TUW	95, 353, 354
S13100FS1.....	141	SDS25212MB.....	75	SDWF2724-TUW	95, 353, 354
S13100FS5.....	141	SDS25212-R25	75	SDWF2726-TUW	95, 353, 354
S13100FSB.....	141	SDS25212SS.....	75, 329	SDWH19300DB.....	70, 311
S13125FS1.....	141	SDS25212SS-R25.....	75	SDWH19300DBMB	70
S13125FS5.....	141	SDS25300	75, 329, 330, 331	SDWH19300DB-R50.....	70
S13125FSB	141	SDS25300MB.....	75	SDWH19300DB-RC12	70
S14050EP1.....	140	SDS25300-R25	75	SDWH19400DB.....	70, 311, 312, 313, 314, 315, 316, 317, 318, 319
S14050EP5.....	140	SDS25300SS.....	75, 329	SDWH19400DBMB	70
S14075EP5.....	140	SDS25300SS-R25.....	75	SDWH19400DB-R50.....	70
S14075HR1	141	SDS25312	75, 329, 330, 331, 332	SDWH19400DB-RC12	70
S14075HR5.....	141	SDS25312MB.....	75		
S14075HRB.....	141	SDS25312-R10	75		

Alphabetical Index

SDWH19400SS.....	324, 325	SDWH271000GR30.....	72	SDWS22800.....	94, 305, 308, 310
SDWH19400SS-R20.....	71	SDWH271000G-RP1.....	72	SDWS22800DB.....	69, 292, 296, 297, 301,
SDWH19400SS-R100.....	71	SDWH271000SS.....	324	302, 303, 305
SDWH19450SS.....	324	SDWH271000SS-R5.....	71	SDWS22800DBMB.....	69
SDWH19450SS-R10.....	71	SDWH271000SS-R25.....	71	SDWS22800DB-R50.....	69
SDWH19450SS-R100.....	71	SDWH271000SS-RP1.....	71	SDWS22800DB-RC12.....	69
SDWH19500SS.....	324, 325	SDWH271200G.....	321, 322, 323	SDWS22800-R50.....	94
SDWH19500SS-R10.....	71	SDWH271200GMB.....	72	SDWS22800-RP1.....	94
SDWH19500SS-R100.....	71	SDWH271200GR30.....	72	SDWS22900.....	94, 308, 310
SDWH19600DB.....	70, 311, 313, 317,	SDWH271200G-RP1.....	72	SDWS22900-R50.....	94
.....	318, 319, 320	SDWH271200SS.....	324	SDWS22900-RP1.....	94
SDWH19600DBMB.....	70	SDWH271200SS-R5.....	71	SDWS221000.....	94, 305, 308, 310
SDWH19600DB-R50.....	70	SDWH271200SS-R25.....	71	SDWS221000DB.....	69, 292, 296, 297, 305
SDWH19600DB-RC12.....	70	SDWH271500G.....	322, 323	SDWS221000DB-R50.....	69
SDWH19600SS.....	324	SDWH271500GMB.....	72	SDWS221000DBRC12.....	69
SDWH19600SS-R10.....	71	SDWS16.....	290	SDWS221000-R50.....	94
SDWH19600SS-R100.....	71	SDWS22.....	304, 305	SDWS221000-RP1.....	94
SDWH19800DB.....	70, 311, 317, 318	SDWS22DB.....	301, 304, 305	SDWS221100.....	94, 308, 310
SDWH19800DBMB.....	70	SDWS22DBB.....	306	SDWS221100-R50.....	94
SDWH19800DB-R50.....	70	SDWS2716-TUW.....	355	SDWS221100-RP1.....	94
SDWH19800DB-RC12.....	70	SDWS2720-TUW.....	355	SDWS221200.....	94, 308, 310
SDWH19800SS.....	324	SDWS2724-TUW.....	355	SDWS221200-R50.....	94
SDWH19800SS-R10.....	71	SDWS16212.....	288, 289, 290, 291	SDWS221200-RP1.....	94
SDWH19800SS-R50.....	71	SDWS16212Q.....	68	SDWS221500.....	94, 308, 310
SDWH27300SS-R10.....	71	SDWS16212QMB.....	68	SDWS221500-R50.....	94
SDWH27300SS-R100.....	71	SDWS16212QR75.....	68	SDWS221500-RP1.....	94
SDWH27300SS-RP1.....	71	SDWS16300.....	288, 289, 290, 291	SDWV13400Z.....	95, 364
SDWH27400G.....	72, 322	SDWS16300Q.....	68	SP5SND1.....	117
SDWH27400GMB.....	72	SDWS16300QMB.....	68	SP5SND5.....	117
SDWH27400GR30.....	72	SDWS16300QR75.....	68	SP5SNDB.....	117
SDWH27400G-RP1.....	72	SDWS19600.....	94, 308, 310	SPS25344-KT.....	152
SDWH27400SS.....	324, 326	SDWS19600-R50.....	94	SS3DSC3BS.....	254, 259
SDWH27400SS-R10.....	71	SDWS19600-RP1.....	94	SS3DSC3BS316.....	254, 259
SDWH27400SS-R100.....	71	SDWS19712.....	94, 308, 310	SS3DSC212BS.....	254, 259
SDWH27400SS-RP1.....	71	SDWS19712-R50.....	94	SS3DSC212BS316.....	254, 259
SDWH27500SS.....	324, 326	SDWS19712-RP1.....	94	SSA8D.....	138, 337
SDWH27500SS-R10.....	71	SDWS22300DB.....	69, 292	SSA8D5.....	138
SDWH27500SS-R50.....	71	SDWS22300DBMB.....	69	SSA8DB.....	138
SDWH27500SS-RP1.....	71	SDWS22300DB-R50.....	69	SSA8DD.....	138
SDWH27600G.....	72, 322	SDWS22300DB-RC12.....	69	SSA10D.....	138, 337
SDWH27600GMB.....	72	SDWS22312DBB.....	73, 306	SSA10D5.....	138
SDWH27600GR30.....	72	SDWS22312DBB-R50.....	73	SSA10DB.....	138
SDWH27600G-RP1.....	72	SDWS22312DBBRC12.....	73	SSA10DD.....	138
SDWH27600SS.....	324	SDWS22400DB.....	69, 292, 293, 294,	SSA16D.....	138, 337
SDWH27600SS-R10.....	71	295, 296, 297, 298, 305, 314, 315	SSA16D5.....	138
SDWH27600SS-R50.....	71	SDWS22400DBMB.....	69	SSA16DB.....	138
SDWH27600SS-RP1.....	71	SDWS22400DB-R50.....	69	SSA16DD.....	138
SDWH27800G.....	322, 323	SDWS22400DB-RC12.....	69	SSDHPD212S.....	254, 257
SDWH27800GMB.....	72	SDWS22500DB.....	69, 292, 293, 294,	SSDHPD212SB.....	257
SDWH27800GR30.....	72	296, 297, 298, 301, 302, 303, 305	SSDTH2S.....	254, 258
SDWH27800G-RP1.....	72	SDWS22500DBMB.....	69	SSDTH3S.....	254, 258
SDWH27800SS.....	324	SDWS22500DB-R50.....	69	SSDTH212S.....	254, 258
SDWH27800SS-R10.....	71	SDWS22500DB-RC12.....	69	SSDWP3S305.....	254, 257
SDWH27800SS-R25.....	71	SDWS22512DBB.....	306	SSDWP3S316.....	254, 257
SDWH27800SS-RP1.....	71	SDWS22512DBBRC12.....	73	SSDWP212S305.....	254, 257
SDWH191000DB.....	70, 311, 317, 318	SDWS22600DB.....	69, 292, 294, 296,	SSDWP212S316.....	254, 257
SDWH191000DB-R50.....	70	297, 298, 299, 305	SSFHSD112S1016.....	283, 287
SDWH191000DBRC12.....	70	SDWS22600DBMB.....	69	SSNA8.....	138, 337
SDWH271000G.....	321, 322, 323	SDWS22600DB-R50.....	69	SSNA8D.....	138
SDWH271000GMB.....	72	SDWS22600DB-RC12.....	69	SSNA8D5.....	138

Alphabetical Index

SSNA8DB.....	138	T4CN5.....	119	T06J050FXM.....	143
SSNA10.....	138	T4CNB.....	119	T06J050PXC.....	142
SSNA10D.....	138, 337	T4FN1.....	121	T06J050PXM.....	142
SSNA10D5.....	138	T4FN5.....	121	T06J075FXC.....	143
SSNA10DB.....	138	T4FNB.....	121	T06J075FXM.....	143
SSPC1BS1012.....	255, 272	T4HACN1.....	118	T06J075PXC.....	142
SSPCSD1B1016-5K.....	104	T4HACN5.....	118	T06J075PXM.....	142
SSPCSD1S1016.....	255, 280, 287	T4HACNB.....	118	T06J100FXC.....	143
SSWSC2BS.....	254, 264	T4KR51.....	114	T06J100FXM.....	143
SSWSC134BS.....	254, 264	T4KR55.....	114	T6KR51.....	114
SSWSC212BS.....	254, 264	T4KR5B.....	114	T6KR55.....	114
STN22.....	73, 306	T4KR71.....	114	T6KR5B.....	114
STN22-R8.....	73	T4KR75.....	114	T6KR71.....	114
		T4KR7B.....	114	T6KR75.....	114
		T4PCS1.....	120	T6KR7B.....	114
		T4PCS5.....	120	T6PCS1.....	120
		T4PCSB.....	120	T6PCS5.....	120
		T4PTD1.....	124	T6PCSB.....	120
		T4PTD5.....	124	T6PSNB.....	125
		T4PTDB.....	124	T6PTD1.....	124
		T4SN71.....	128	T6PTD5.....	124
		T4SN75.....	128	T6PTDB.....	124
		T4SN7B.....	128	T6SBX1.....	115
		T4SND1.....	117	T6SBX5.....	115
		T4SND5.....	117	T6SBXB.....	115
		T4SNDB.....	117	T6SN71.....	128
		T5ABN1.....	115	T6SN75.....	128
		T5ABN5.....	115	T6SN7B.....	128
		T5ABNB.....	115	T6SND1.....	117
		T5ACN1.....	118	T6SND5.....	117
		T5ACNB.....	118	T6SNDB.....	117
		T5CNB.....	119	T6SNDGB.....	126
		T5FN1.....	121	T6SNDR5.....	126
		T5FNB.....	121	T6SNDRB.....	126
		T5KR51.....	114	T6SNDWB.....	126
		T5KR55.....	114	T7ABN1.....	115
		T5KR5B.....	114	T7ABN5.....	115
		T5KR71.....	114	T7ABNB.....	115
		T5KR75.....	114	T7ACNB.....	118
		T5KR7B.....	114	T07C162PAK.....	86
		T5SN71.....	128	T07C225PAK.....	86
		T5SN75.....	128	T07C300PAK.....	86
		T5SN7B.....	128	T7CN1.....	119
		T5SND1.....	117	T7KR51.....	114
		T5SND5.....	117	T7KR55.....	114
		T5SNDB.....	117	T7KR5B.....	114
		T6ABN1.....	115	T7KR71.....	114
		T6ABN5.....	115	T7KR75.....	114
		T6ABNB.....	115	T7KR7B.....	114
		T6ACN1.....	118	T7SN71.....	128
		T6ACN5.....	118	T7SN75.....	128
		T6ACNB.....	118	T7SN7B.....	128
		T6AKR1.....	114	T7SND1.....	117
		T6AKR5.....	114	T7SND5.....	117
		T6AKRB.....	114	T7SNDB.....	117
		T6CN1.....	119	T8ABN1.....	115
		T6CNB.....	119	T8ABN5.....	115
		T6FN1.....	121	T8ABNB.....	115
		T6FN5.....	121	T8ACN1.....	118
		T6FNB.....	121	T8ACN5.....	118
		T06J050FXC.....	143	T8ACNB.....	118

T

T2ACN1.....	118
T2ACN5.....	118
T2ACNB.....	118
T2CN1.....	119
T2CNB.....	119
T2FN1.....	121
T2FNB.....	121
T2KR51.....	114
T2KR55.....	114
T2KR5B.....	114
T2KR71.....	114
T2KR75.....	114
T2KR7B.....	114
T3ABNB.....	115
T3ACDRWWR1.....	117
T3ACDRWWR5.....	117
T3ACN1.....	118
T3ACN5.....	118
T3ACNB.....	118
T3CN1.....	119
T3CNB.....	119
T3FN1.....	121
T3FN5.....	121
T3FNB.....	121
T3KR51.....	114
T3KR55.....	114
T3KR5B.....	114
T3KR71.....	114
T3KR75.....	114
T3KR7B.....	114
T3PCS1.....	120
T3PCS5.....	120
T3PCSB.....	120
T3SN71.....	128
T3SN75.....	128
T3SN7B.....	128
T3SND1.....	117
T3SND5.....	117
T3SNDB.....	117
T4ABN1.....	115
T4ABN5.....	115
T4ACN1.....	118
T4ACN5.....	118
T4ACNB.....	118
T4CN1.....	119

Alphabetical Index

T8AKR1	114	T8SNDBB	126	T10N062SWC	153
T8AKR5	114	T8SNDW1	126	T10PTD1	124
T8AKRB	114	T8SNDW5	126	T10PTD5	124
T8APBB	123	T8SNDWB	126	T10PTDB	124
T08C125WQC	145	T8VTN2.4UP	162	T10S300CNJ	171
T08C125WQM	145	T8VTN1000	139	T10S350CNB	171
T08C162WQC	145	T9A150MCN	159, 337	T10S350CNJ	171
T08C162WQM	145	T9A250MCN	159, 337	T10SND1	117
T08C200PAK	84	T10A150MCN	159, 337	T10SND5	117
T08C225WQC	145	T10A175X0C	122	T10SNDB	117
T08C225WQM	145	T10A200X07	122	T10SNDBB	126
T8CN1	119	T10A250MCN	159, 337	T10SNDW1	126
T8CN5	119	T10A300CNB	170	T10SNDW5	126
T8CNB	119	T10A300CNJ	170	T10SPBX1	115
T8CRD1	116	T10A300PNJ	167	T10SPBX5	115
T8CRD5	116	T10A325CNB	170	T10SPBXB	115
T8CRDB	116	T10A325CNJ	170	T11A100RNJ	165
T8FN1	121	T10A325T31	175	T11A125RNJ	165
T8FN5	121	T10A350CNB	170	T11A150RNJ	165
T8FNB	121	T10A350CNJ	170	T11A175RNJ	165
T8HPTD1	124	T10A350PNJ	167	T11A250CNB	170
T8HPTD5	124	T10ABN1	115	T11A250CNJ	170
T8HPTDB	124	T10ABN5	115	T11A300CNB	170
T08J075FXC	143	T10ABNB	115	T11A300CNJ	170
T08J075FXM	143	T10ACN1	118	T11A300PNJ	167
T08J075PXC	142	T10ACN5	118	T11A300T31	175
T08J075PXM	142	T10ACNB	118	T11A325CNB	170
T08J100FXC	143	T10AKR1	114	T11A325CNJ	170
T08J100FXM	143	T10AKR5	114	T11A325PNJ	167
T08J100PXC	142	T10AKRB	114	T11N150RNJ	166
T08J100PXM	142	T10C250PAK	84	T11N175RNJ	166
T08J125FXC	143	T10C300PAK	84	T11S300CNB	171
T08J125FXM	143	T10CN1	119	T11S300CNJ	171
T08J125PXC	142	T10CN5	119	T11S325CNB	171
T08J125PXM	142	T10CNB	119	T11S325CNJ	171
T08J150FXC	143	T10CRD1	116	T12A200CNB	170
T08J150FXM	143	T10CRD5	116	T12A200CNJ	170
T08J150PXC	142	T10CRDB	116	T12A200PNB	167
T08J150PXM	142	T10FN1	121	T12A225PNJ	167
T8KR51	114	T10FN5	121	T12A237B31	173
T8KR55	114	T10FNB	121	T12A237CNB	170
T8KR5B	114	T10HPTD1	124	T12A237CNJ	170
T8KR71	114	T10HPTD5	124	T12A237T31	175
T8KR75	114	T10HPTDB	124	T12A250PNB	167
T8KR7B	114	T10J075PXC	142	T12A250PNJ	167
T8PCS1	120	T10J075PXM	142	T12ABN1	115
T8PCS5	120	T10J100FXC	143	T12ABN5	115
T8PCSB	120	T10J100FXM	143	T12ABNB	115
T8PSNB	125	T10J100PXC	142	T12ACN1	118
T8PTD1	124	T10J100PXM	142	T12ACN5	118
T8PTD5	124	T10J125PXC	142	T12ACNB	118
T8PTDB	124	T10J125PXM	142	T12AKR1	114
T8SBX1	115	T10J150FXC	143	T12AKR5	114
T8SBX5	115	T10J150FXM	143	T12AKRB	114
T8SBXB	115	T10J150PXC	142	T12CN1	119
T8SN71	128	T10J150PXM	142	T12CRD1	116
T8SN75	128	T10J200FXC	143	T12CRD5	116
T8SN7B	128	T10J200FXM	143	T12FN1	121
T8SND1	117	T10KR71	114	T12FN5	121
T8SND5	117	T10KR75	114	T12FNB	121
T8SNDB	117	T10KR7B	114	T12J100PXC	142

Alphabetical Index

T12J100PXM.....	142	T16FN1.....	121	T20CNB.....	119
T12J150PXC.....	142	T16FN5.....	121	T20FN1.....	121
T12J150PXM.....	142	T16FNB.....	121	T20FN5.....	121
T12J200PXC.....	142	T16HPTD1.....	124	T20FNB.....	121
T12J200PXM.....	142	T16HPTD5.....	124	T20HPTD5.....	124
T12KR71.....	114	T16HPTDB.....	124	T20HPTDB.....	124
T12KR75.....	114	T16KR4B.....	114	T20PTD1.....	124
T12KR7B.....	114	T16KR41.....	114	T20PTD5.....	124
T12N062SWM.....	153	T16KR45.....	114	T20PTDB.....	124
T12PTD1.....	124	T16N075N11.....	185	T20SND1.....	117
T12PTD5.....	124	T16N100P53.....	182	T20SND5.....	117
T12PTDB.....	124	T16N125FNB.....	177	T20SNDB.....	117
T12S200CNB.....	171	T16N125FNJ.....	177	T25N112SWC.....	153
T12S200CNJ.....	171	T16N125N15.....	185	T30ACN5.....	118
T12S250CNB.....	171	T16N150FNB.....	177	T30ACNB.....	118
T12S250CNJ.....	171	T16N150FNJ.....	177	T30CNB.....	119
T12SND1.....	117	T16N150N17.....	185	T40ACN1.....	118
T12SND5.....	117	T16N150PFB.....	176	T40ACN5.....	118
T12SNDB.....	117	T16N150PFN.....	176	T40ACNB.....	118
T13A12SSNJ.....	163	T16N175N19.....	185	T40CN5.....	119
T13A125SNJ.....	163	T16N200FNB.....	177	T40CNB.....	119
T13A150IPBP.....	161	T16N200FNJ.....	177	T60ACN1.....	118
T13A150IPC.....	161	T16N200N21.....	185	T60ACN5.....	118
T13A150SNJ.....	163	T16N200PFB.....	176	T60ACNB.....	118
T13A175IPBP.....	161	T16N200PFN.....	176	T60APBB.....	123
T13A175IPC.....	161	T16N250FNB.....	177	T60CN1.....	119
T13A175SNJ.....	163	T16N250FNJ.....	177	T60CN5.....	119
T13A200IPBP.....	161	T16N250PFB.....	176	T60CNB.....	119
T13A200IPC.....	161	T16N250PFN.....	176	T70ACN1.....	118
T13A200SNJ.....	163	T16PTD1.....	124	T70ACNB.....	118
T13A225IPBP.....	161	T16PTD5.....	124	T210ARN1.....	130
T13A225IPC.....	161	T16PTDB.....	124	T210ARN5.....	130
T13A225SNJ.....	163	T16SND1.....	117	T210ARNB.....	130
T13A250IPBP.....	161	T16SND5.....	117	T310ARN1.....	130
T13A250IPC.....	161	T16SNDB.....	117	T310ARN5.....	130
T13A250SNJ.....	163	T18N037FNJ.....	178	T310ARNB.....	130
T15N125SFN.....	180	T18N050FNJ.....	178	T311ARN1.....	130
T15N150FNB.....	176	T18N062FNJ.....	178	T311ARN5.....	130
T15N150FNJ.....	176	T18N062L10.....	184	T311ARNB.....	130
T15N150SFB.....	180	T18N075FNB.....	178	T410ARN1.....	130
T15N150SFN.....	180	T18N075FNJ.....	178	T410ARN5.....	130
T15N200FNB.....	176	T18N075L11.....	184	T410ARNB.....	130
T15N200FNJ.....	176	T18N100FNB.....	178	T411ARN1.....	130
T15N200SFB.....	180	T18N100FNJ.....	178	T411ARN5.....	130
T15N200SFN.....	180	T18N100L13.....	184	T411ARNB.....	130
T15N250FNB.....	176	T18N112L14.....	184	T510ARN1.....	130
T15N250FNJ.....	176	T18N125FNB.....	178	T510ARN5.....	130
T15N250SFB.....	180	T18N125FNJ.....	178	T510ARNB.....	130
T15N250SFN.....	180	T18N125L15.....	184	T610ARN1.....	130
T16ABN1.....	115	T18N150FNB.....	178	T610ARN5.....	130
T16ABN5.....	115	T18N150FNJ.....	178	T610ARNB.....	130
T16ABNB.....	115	T18N150L17.....	184	T611ARNB.....	130
T16ACN1.....	118	T18N175FNJ.....	178	T810ARN1.....	130
T16ACN5.....	118	T18N200FNB.....	178	T810ARN5.....	130
T16ACNB.....	118	T18N200FNJ.....	178	T810ARNB.....	130
T16AKR1.....	114	T20ABNB.....	115	T1010ARN1.....	130
T16AKR5.....	114	T20ACN1.....	118	T1010ARN5.....	130
T16AKRB.....	114	T20ACN5.....	118	T1010ARNB.....	130
T16CN1.....	119	T20ACNB.....	118	T07162FB1.....	86
T16CN5.....	119	T20CN1.....	119	T07162FB5.....	86
T16CNB.....	119	T20CN5.....	119	T07162FBB.....	86

Alphabetical Index

T07162FT1WH01	87	T07300FBB	86	T10200WPB	79
T07162FT5WH01	87	T07300FWP	81	T10250DB1	84
T07162FTBBK	87	T07300WCI	81	T10250DB5	84
T07162FTBBR01	87	T07300WJI	81	T10250DBB	84
T07162FTBGR	87	T07300WP1	81	T10250DT1	83
T07162FTBGR01	87	T07300WP5	81	T10250DT5	83
T07162FTBTN02	87	T07300WPB	81	T10250DTB	83
T07162FTBWH01	87	T07300WPP	81	T10250DXB	91
T07162FTPBK	87	T7510ARN1	130	T10250DXP	91
T07162FTPBR01	87	T7510ARN5	130	T10250WP1	79
T07162FTPGR	87	T7510ARNB	130	T10250WP5	79
T07162FTPGR01	87	T08100HDUC	147	T10250WPB	79
T07162FTPPTN02	87	T08100HDUM	147	T10250WPP	79
T07162FTPWH01	87	T08125DB1	84	T10300DB1	84
T07162FWP	81	T08125DB5	84	T10300DB5	84
T07162WCI	81	T08125DBB	84	T10300DBB	84
T07162WJI	81	T08125WP1	79	T10300DT1	83
T07162WP1	81	T08125WP5	79	T10300DT5	83
T07162WP5	81	T08125WPB	79	T10300DXB	91
T07162WPB	81	T08162DB1	84	T10300DXP	91
T07162WPP	81	T08162DB5	84	T10300WP1	79
T07225FB1	86	T08162DBB	84	T10300WP5	79
T07225FB5	86	T08162WP1	79	T10300WPB	79
T07225FBB	86	T08162WPB	79	T10300WPP	79
T07225FT1WH01	87	T08162WPP	79	T10350DB1	84
T07225FT5WH01	87	T08200DB1	84	T10350DB5	84
T07225FTB	88	T08200DB5	84	T10350DBB	84
T07225FTBBR01	87	T08200DBB	84	T10350WP1	79
T07225FTBBR05	87	T08200WP1	79	T10350WPB	79
T07225FTBGR	87	T08200WP5	79	T10350WPP	79
T07225FTBGR01	87	T08200WPB	79	T10450WPCM	79
T07225FTBGR03	87	T08200WPP	79	T12100HDUC	147
T07225FTBGR04	87	T08250DB1	84	T12100HDUM	147
T07225FTBRD01	87	T08250DB5	84	T12100XOC	148
T07225FTBTN	87	T08250DBB	84	T12100XOM	148
T07225FTBTN01	87	T08250FT1	88	T12150HDUC	147
T07225FTBTN02	87	T08250FT5	88	T12150HDUM	147
T07225FTBTN03	87	T08250FTB	88	T12150XOC	148
T07225FTBTN04	87	T08250WPF1	79	T12150XOM	148
T07225FTBWH01	87	T08250WPF5	79	T12200HDUC	147
T07225FTPBR01	87	T08250WPFB	79	T12200HDUM	147
T07225FTPBR05	87	T08300WPF1	79	T12200XOC	148
T07225FTPGR	87	T08300WPF5	79	T12200XOM	148
T07225FTPGR01	87	T08300WPFB	79	T12250DBB	84
T07225FTPGR03	87	T09100HWAC	146	T12250HDUC	147
T07225FTPGR04	87	T09100HWAM	146	T12250HDUM	147
T07225FTPRD01	87	T09100HWHC	146	T12250WP1	79
T07225FTPTN	87	T09100HWHM	146	T12250WP5	79
T07225FTPTN01	87	T09150HWAC	146	T12250WPB	79
T07225FTPTN02	87	T09150HWAM	146	T12300DBB	84
T07225FTPTN03	87	T09150HWHC	146	T12300HDUC	147
T07225FTPTN04	87	T09150HWHM	146	T12300HDUM	147
T07225FWP	81	T09200HWAC	146	T12300WP1	79
T07225WCI	81	T09200HWAM	146	T12300WP5	79
T07225WJI	81	T09200HWHC	146	T12300WPB	79
T07225WP1	81	T09200HWHM	146	T12350DBB	84
T07225WP5	81	T10200DB1	84	T12350WP1	79
T07225WPB	81	T10200DB5	84	T12350WP5	79
T07225WPP	81	T10200DBB	84	T12350WPB	79
T07300FB1	86	T10200WP1	79	T12400DB5	84
T07300FB5	86	T10200WP5	79	T12400DBB	84

Alphabetical Index

T12400HDUM.....	147	TBP1475S	274	XQ114S1224	255, 278, 287, 380, 382
T12400WP1.....	79	TBP1478S	255	XU34B1016-5K	98, 382
T12400WP5.....	79	TOOLCASE-LG.....	249	XU34S1016	278, 382
T12400WPB.....	79	TPO15	155		
T12400WPP.....	79	TSV214R70WH01	144		
T12450DBB.....	84				
T12450WP1.....	79				
T12450WP5.....	79				
T12450WPB.....	79				
T12500DB5	84	W		Z	
T12500DBB.....	84	WDPLUG2M.....	155	Z25CWWNC.....	152
T12500WP1.....	79	WDPLUG-100.....	155		
T12500WP5.....	79	WSC112S.....	254, 273		
T12500WPB.....	79	WSC114S-17	254, 273		
T12600DB5	84	WSCD3S	254, 264		
T12600DBB.....	84	WSCD212S	254, 264		
T12600WP1.....	79	WSCG134S	254, 263		
T12600WP5.....	79	WSCLT134S	254, 273		
T12600WPB.....	79	W SCT212S.....	254, 264		
T14300WP1.....	79	WSF1LRVS.....	283		
T14300WP5.....	79	WSF134LRVS.....	255, 283		
T14300WPB.....	79	WSHL134S7.....	254, 270		
T14350WP1.....	79	WSNTL2LS.....	254, 268, 367		
T14350WP5.....	79	WSNTL2R100.....	96		
T14350WPB.....	79	WSNTL2R500.....	96		
T14400DB1	84	WSNTL3R60.....	96		
T14400DB5	84	WSNTL3R300.....	96		
T14400DBB.....	84	WSNTL3S.....	254, 268, 367, 368		
T14400WP5.....	79	WSNTL134S.....	254, 268		
T14400WPB.....	79	WSNTL212R80.....	96		
T14400WPP.....	79	WSNTL212R400.....	96		
T14500DB1	84	WSNTL212S.....	254, 268, 367, 368		
T14500DB5	84	WSNTLG2S	254, 267		
T14500DBB.....	84	WSNTLG3S	254, 267		
T14500WP1.....	79	WSNTLG212S.....	254, 267		
T14500WP5.....	79	WSNTLQ3S	254, 267		
T14500WPB.....	79	WSNTLQ212S.....	254, 267		
T14600DB1	84	WSV134S	254, 267		
T14600DB5	84				
T14600DBB.....	84				
T14600WP1.....	79				
T14600WP5.....	79				
T14600WPB.....	79				
TB1445S.....	255, 274, 287	X			
TB1460S.....	255, 274, 287, 365	X1B1016-4K.....	98, 382		
TB1475S.....	255, 274, 287, 365	X1B1214-3.5K.....	98		
TBG1245S.....	255, 274	X1S1016.....	255, 278, 287, 380, 382		
TBG1260R1500.....	100	X1S1214.....	255, 278, 287, 380		
TBG1260S.....	255, 274	X34B1016-5K.....	98, 382		
TBG1445S.....	255, 274	X114B1224-2.5K.....	382		
TBG1460S.....	255, 274, 365	X114S1224.....	382		
TBG1475S.....	255, 274, 365	XEQ34B1016.....	287		
TBP1245R50.....	100	XEQ34B1016C.....	98		
TBP1245R2000.....	100	XEQ34B1016M.....	98		
TBP1245S.....	255, 274	XLQ114B1224-2K.....	97, 382		
TBP1260S.....	255, 274	XLQ114T1224.....	255, 277, 287, 382		
TBP1460R50.....	100	XMQ114B1224-2K.....	97, 382		
TBP1460R1000.....	100	XMQ114S1224.....	255, 277, 287, 382		
TBP1460S.....	255, 274	XQ1B1016-4K.....	98, 382		
TBP1475R50.....	100	XQ1B1214-3.5K.....	98		
TBP1475R1000.....	100	XQ1S1016.....	255, 278, 380, 382		
		XQ1S1214.....	255, 278, 380		
		XQ112B1224-2K.....	98, 382		
		XQ112S1224.....	255, 278, 287, 380, 382		
		XQ114B1224-2.5K.....	98, 382		

Nothing else drives this easy.

Simpson Strong-Tie® fasteners are precision engineered and rigorously tested to meet your most demanding applications. Our unique, patented features deliver speed and ease of installation, as well as exceptional performance.

Drive faster. Drive stronger. Drive easier.

SIMPSON

Strong-Tie

®



6-Lobe

Deep six-lobe recessed head provides a secure bit retention for fewer cam-outs



No Pre-Drilling

SawTooth™ point design for fast starts and no predrilling



Flush Finish

Ribbed-head design countersinks easily and provides a clean, finished appearance



Low Torque

Low-torque threads allow up to 35% more screws to be driven on a battery charge



Stainless Steel

Type 316 stainless steel for maximum corrosion protection



Strong-Drive® SDWH TIMBER-HEX HDG Screw



Deck-Drive™ DSV WOOD Screw



Strong-Drive® WSV SUBFLOOR Screw



Strong-Drive® SDWH TIMBER-HEX SS Screw

